

Pagina
06
pana la
09

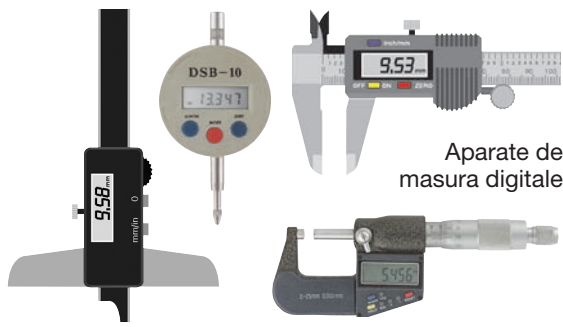

Aparate de masura digitale

Pagina
38
pana la
41



Instrumente de trasare, trasor pe inaltime, compas

Pagina
10
pana la
15

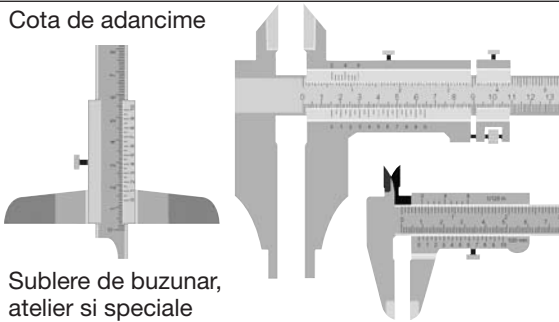

Cota de adancime

Sublere de buzunar, atelier si speciale

Pagina
42
pana la
50

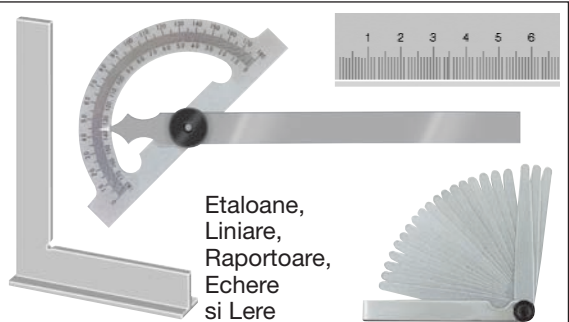

Etaloane, Liniare, Raportoare, Echere si Lere

Pagina
16
pana la
22



Micrometre de exterior, interior si de adancime, aparate masura cilindru, Dispozitiv de masurat grosimea

Pagina
51
pana la
53

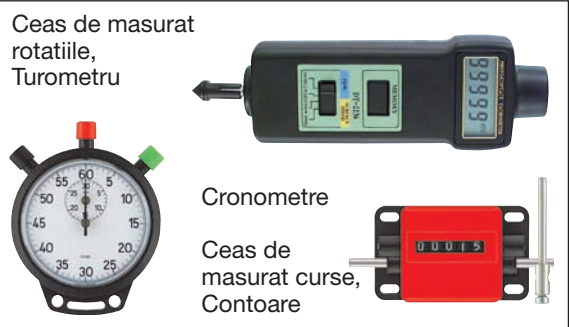

Ceas de masurat rotatiile, Turometru

Cronometre

Ceas de masurat curse, Contoare

Pagina
23
pana la
29

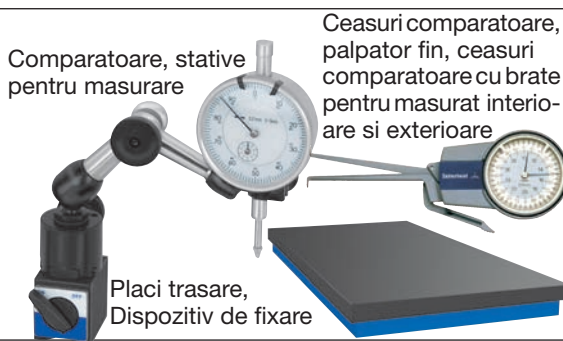

Comparatoare, stative pentru masurare

Ceasuri comparatoare, palpator fin, ceasuri comparatoare cu brate pentru masurat interioare si exterioare

Placi trasare, Dispozitiv de fixare

Pagina
53
pana la
57

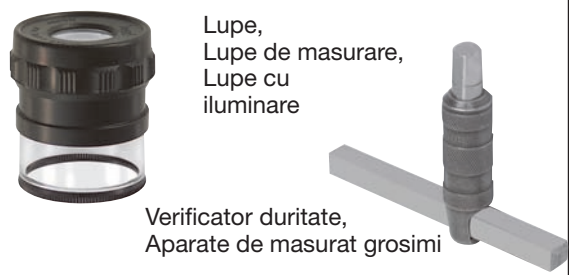

Lupe, Lupe de masurare, Lupe cu iluminare

Verificator duritate, Aparate de masurat grosimi

Pagina
30
pana la
37



Rulete, Aparate de masura distante

Aparat de masura distante

Pagina
58
pana la
66



Aparate de masura electrice, temperatura, vant, unde sonore, umiditate, gaze explozive s.a

Cantare mecanice, cantare digitale

0102 -...»MAXIMA« SUBLERE DE BUZUNAR DIN OTEL INOXIDABIL

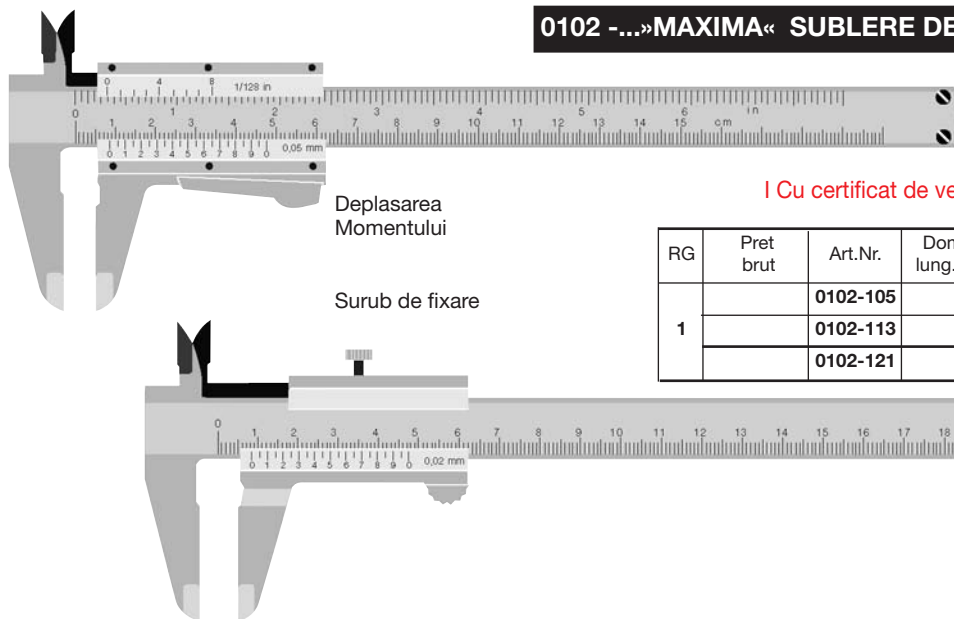

Deplasarea Momentului

Surub de fixare

Executie: **otel inoxidabil cromat**, cu varfuri pentru masurare interioara, varfuri in cruce si cote de adancime pt. suprafetele de masurare calite, in husa

I Cu certificat de verificare conform **DIN 862 conform ISO 9000**

RG	Pret brut	Art.Nr.	Dom.masurare x lung.varfurilor/mm	Vernier	Executie
1		0102-105	155 x 40	1/20 mm	cu reglare a momentului
		0102-113	155 x 40	1/128 tol	cu surub de fixare
		0102-121	200 x 40	1/20 mm	cu surub de fixare

0104-...»MAXIMA« SUBLERE DE BUZUNAR CU CEAS DE MASURARE

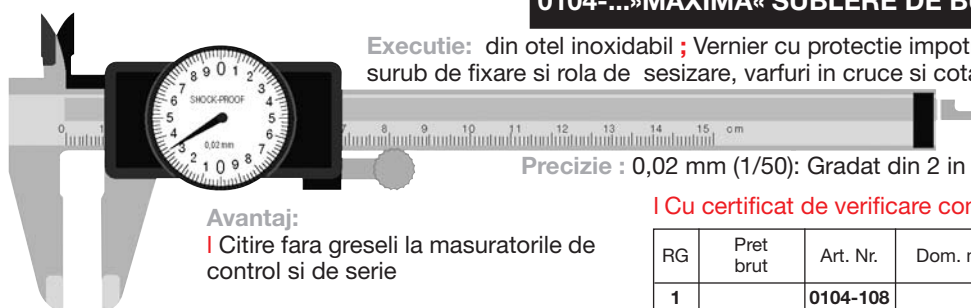

Executie: din otel inoxidabil ; Vernier cu protectie impotriva impactului cu scala reglabila; cu surub de fixare si rola de sesizare, varfuri in cruce si cota de adancime, in husa

Precizie : 0,02 mm (1/50): Gradat din 2 in 2 mm

I Cu certificat de verificare conform **DIN 862 conform ISO 9000**

Avantaj:

I Citire fara greseli la masuratorile de control si de serie

RG	Pret brut	Art. Nr.	Dom. masurare x lung. varfurilor/mm	Citire/mm
1		0104-108	150 x 40	0,02 (1/50)

5512-... SUBLERE DE BUZUNAR DIGITALE »DIGIMAX«

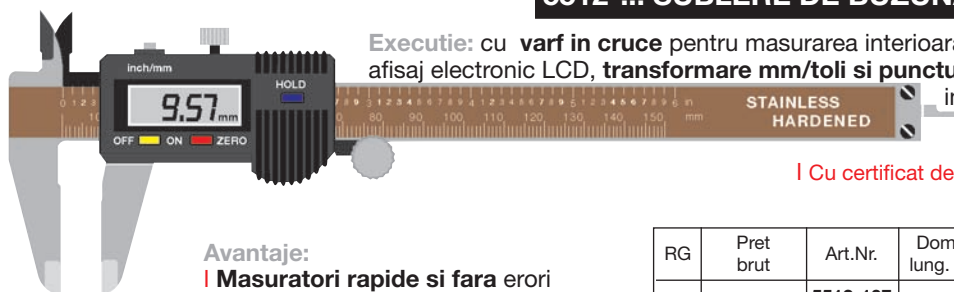

Executie: cu **varf in cruce** pentru masurarea interioara, varfuri de masurare, tija de adancime si afisaj electronic LCD, transformare mm/toli si punctul de zero se poate stabili arbitrar; se livreaza in caseta

I Cu certificat de verificare conform **DIN 862 conform ISO 9000**

Avantaje:

I Masuratori rapide si fara erori
I Viteza maxima de procesare, precizie maxima

RG	Pret brut	Art.Nr.	Dom. masurare x lung. varfurilor/mm	Citire in mm	Precizie /mm	Precizie de repetare/mm
141		5512-107	155 x 40	0,01	+/- 0,02	0,01
		5512-115	200 x 40	0,01	+/- 0,02	0,01

0192-... SUBLERE DIGITALE PENTRU ATELIER »DIGIMAX«

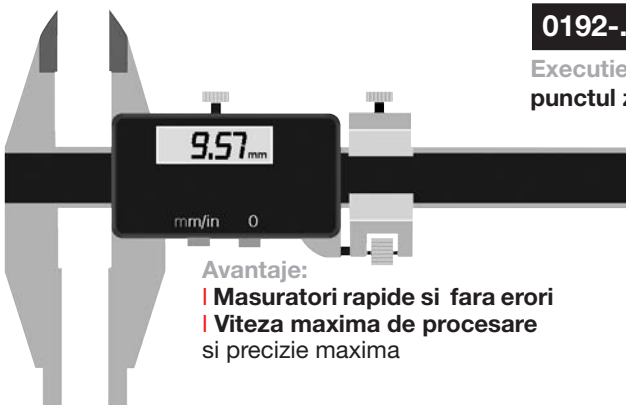

Executie: inoxidabil cromat; afisare electronica LCD, transformare mm/toli, punctul zero reglabil arbitrar; cu varfuri si reglaj fin; se livreaza in caseta.

I Cu certificat de verificare conform **DIN 862 conform ISO 9000**

Avantaje:

I Masuratori rapide si fara erori
I Viteza maxima de procesare si precizie maxima

RG	Pret brut	Art. Nr.	Dom. masurare x lung. varfurilor/mm	Citire in mm	Precizie in mm	Precizie de repetare/mm
141		0192-104	300 x 90	0,01	+/- 0,04	0,01
		0192-112	500 x 150	0,01	+/- 0,04	0,01

Verificarea sublerelor

I verificare vizuala si functionala

I Valoare necesara: Masurare exterioara

I Valoare necesara: Masurare interioara

I Valoare necesara: Masurare Sectionala

I Valoare necesara: Masurare adancime

0156-... SUBLERE DE PRECIZIE SI CONTROL

Executie: din otel inoxidabil, scala si vernierul impecabile, cromate, suprafetele de masurare si ghidajele sunt calite si finisate; se livreaza in caseta; executia „cu varfuri si reglaj fin“

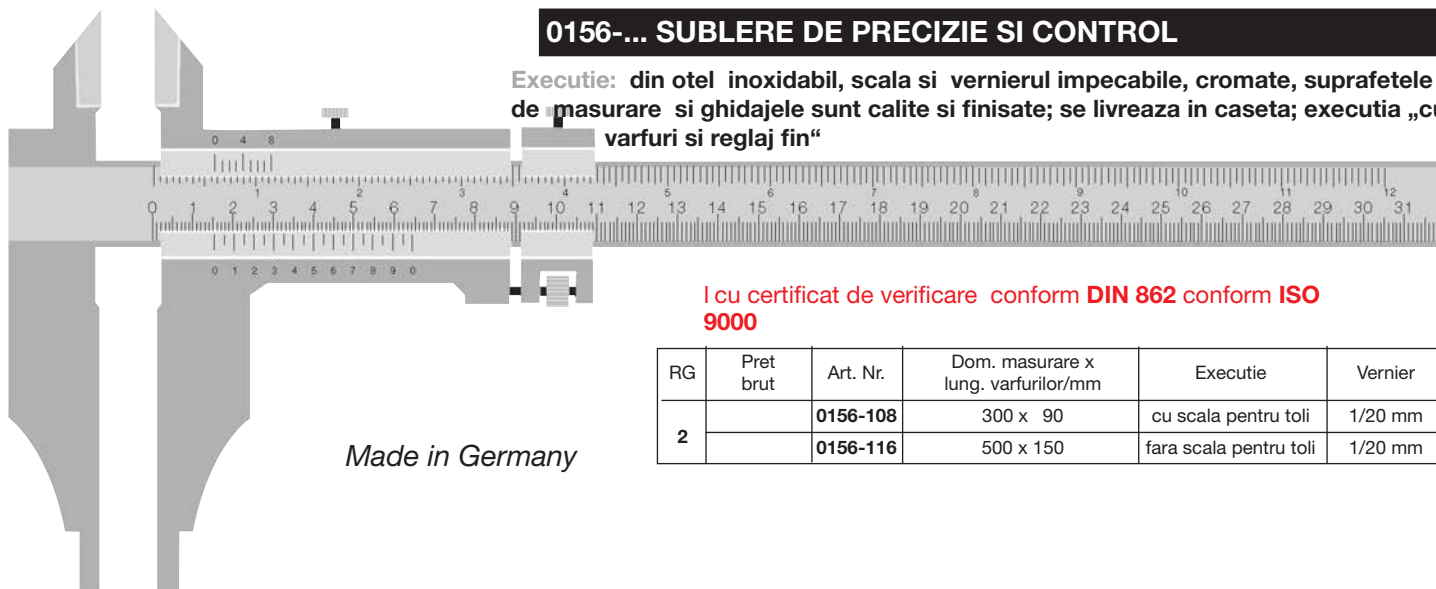

Made in Germany

I cu certificat de verificare conform DIN 862 conform ISO 9000

RG	Pret brut	Art. Nr.	Dom. masurare x lung. varfurilor/mm	Executie	Vernier
2		0156-108	300 x 90	cu scala pentru toli	1/20 mm
		0156-116	500 x 150	fara scala pentru toli	1/20 mm

0110-.../0111-... »MAXIMA« MICROMETRU DE PRECIZIE

Cu suprafete de carburi, clema de blocare si clichet sensor, pasul filetului 0,5 mm, fusul Ø 6,5 mm; taler de masurare cu gradatie de 50, citire 0,01 mm, toate piesele de citire cromate, etrierul lacuit, cu protectie izolatoare ptr mana, se livreaza in caseta

I cu certificat de verificare conform DIN 863/1 conform ISO 9000

RG	Pret brut	Art. Nr.	Dom. de masurare/mm
1		0110-205	0 - 25
		0110-213	25 - 50
		0110-221	50 - 75
		0110-230	50 - 100
		0111-201	Garnitura-micrometru de precizie 0 - 100 mm, 4 piese , in caseta de lemn

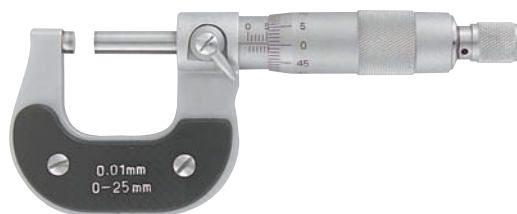

5584-... »MAXIMA« RAPORTOR UNIVERSAL cu lupa de citire

din otel inoxidabil, scala cromata, gradatia: 4 ori 90°, Citire Vernier 5 minute unghiulare, cu sine deplasabile 300 mm si unghi suplimentar, se livreaza in caseta

Utilizare: universal ca masurator de grade, unghi de imbinare precum si pentru controlul pieselor.

I cu certificat de verificare conform ISO 9000

RG	Pret brut	Art.Nr.	Executie
2		5584-051	Universal ca masurator de grade complet cu lupa

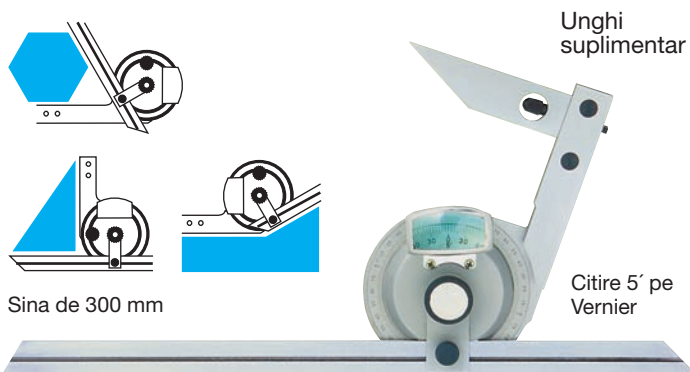

5584-... »MAXIMA« RAPORTOR UNIVERSAL CU CEAS DE MASURA

Din otel inoxidabil, scala rotunda 4 ori 90°, citirea 5 minute unghiulare, cu sine deplasabile 150, 200 si 300 mm si unghi suplimentar, se livreaza in caseta

Utilizare: ca si masurator de grade universal, unghi de imbinare precum si pentru controlul pieselor.

I cu certificat de verificare conform ISO 9000

RG	Pret brut	Art.Nr.	Executie
2		5584-060	Raportor universal cu ceas de masura

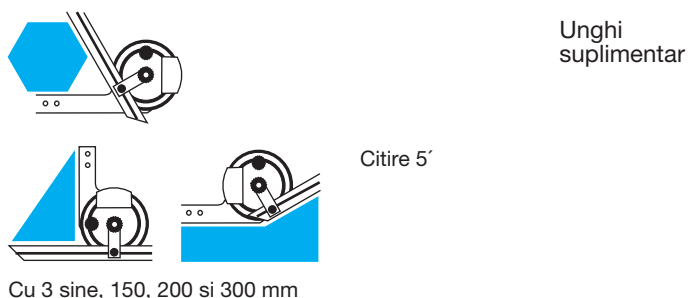



8 mm / h 6

0137-... COMPARATOR DE PRECIZIE

Precizie conform DIN 878-A, protejat impotriva impactului, citire 0,01 mm, diametrul exterior \varnothing 58 mm, canal de fixare 8 mm/h6 –calit, filet interior M2,5/6g, cu doua marcaje reglabile de toleranta; bolt de masurare si canalul de fixare din otel inoxidabil; in caseta de plastic

I cu certificat de verificare conform DIN 878 conform ISO 9000

RG	Pret brut	Art. Nr.	Dom. masurare in mm	Model	Executie
1		0137-201	0 - 10	A	cu spate plat

0257-... SET CALE PLAN PARALELE conf. EN-ISO 3650

Din otel special detensionat, calit si rodat, executie speciala, rezistenta la uzura, in caseta de lemn

I cu certificat de garantie conform ISO 9000

RG	Pret brut	Art.Nr.	Executie
2		0257-206	Calitate 1: cu 47 masuri finale

cale individuale (cu sau fara certificat de verificare conform ISO 9000)

Se pot livra la cerere

Va rugam solicitati lista speciala !

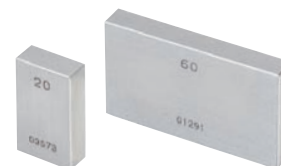

Seturi de cale plan paralele conform EN-ISO 3650

Din carburi respectiv ceramica,

verificat conform ISO 9000; livrabil la cerere

I Lerele si aparatele de trasare de inalta precizie se pot fabrica si cu seturile de cale plan paralele existente



0257-... SET ACCESORII CALE PLAN PARALELE

I Servesc la utilizarea mai buna a setului de cale Nu se achizitioneaza aparate de masura scumpe si putin utilizabile

RG	Pret brut	Art. Nr.	Setul de accesorii cuprinde:
2		0257-079	Set-accesorii-mas.fin.14-componente, in caseta de lemn: 2 suporturi reglabile pentru cale 4 perechi varfuri de masurat cu prelungire cilindrica 2 perechi varfuri de masurat cu prelungire inclinata

Utilizabile de ex. ca lera de reglare ptr. aparate de masura de interior si cilindrice Nr. Art. 0123-...(nu sunt necesare inele de reglare), compas de trasare, lera circulara limita, ac de trasare de inaltimi de precizie etc!

0232-...LINIAR CU MUCHIE ASCUTITA INOXIDABILA conf.DIN 874/00

Din otel special inoxidabil, calit, muchie de masurare cu prelucrare fina, tesitura impecabila, protectie izolatoare; in husa de piele Utilizare : pentru verificari (metoda fantei de lumina)

I cu certificat de verificare conform ISO 9000



DIN 874/00

Tesitura impecabila

RG	Pret brut	Art. Nr.	Lungime/mm	Pret brut	Art. Nr.	Lungime/mm
2		0232-157	75		0232-190	300
		0232-165	100		0232-203	400
		0232-173	150		0232-211	500
		0232-181	200			

Instrumente de masura cu certificat de verificare conform ISO 9000

0233-... LINIAR PENTRU MASURARE PRECISA conform DIN 874/1

Executie: din otel inoxidabil

RG	Pret brut	Art. Nr.	Lungime x Latime x Grosime/mm	Pret brut	Art. Nr.	Lungime x Latime x Grosime/mm
2		0233-307	500 x 40 x 8		0233-323	1500 x 60 x 12
		0233-315	1000 x 50 x 10		0233-331	2000 x 70 x 14

0231-... RIGLE PENTRU MASURARE PRECISA conform DIN 866/1(A)

Executie: din otel inoxidabil

RG	Pret brut	Art. Nr.	Lungime x Latime x Grosime/mm	Pret brut	Art. Nr.	Lungime x Latime x Grosime/mm
2		0231-207	500 x 30 x 6		0231-223	1500 x 40 x 8
		0231-215	1000 x 40 x 8		0231-231	2000 x 50 x 10

0231-... RIGLE PENTRU MASURARE PRECISA conform DIN 866/2(A)

Executie: din otel inoxidabil

RG	Pret brut	Art. Nr.	Lungime x Latime x Grosime/mm	Pret brut	Art. Nr.	Lungime x Latime x Grosime/mm
2		0231-304	1000 x 30 x 6		0231-321	3000 x 40 x 8
		0231-312	2000 x 40 x 8			

0275-... RIGLE DE MASURAT FLEXIBILE FINE late

Executie: din otel inoxidabil, gradatie-mm sus si jos.

RG	Pret brut	Art. Nr.	Lungime x Latime x Grosime/mm	Pret brut	Art. Nr.	Lungime x Latime x Grosime/mm
2		0275-123	1000 x 30 x 1		0275-140	2000 x 30 x 1

0181-... ECHER DREPT conform DIN 875/1

Executie: din otel inoxidabil

RG	Pret brut	Art. Nr.	Dimensiuni in mm	Pret brut	Art. Nr.	Dimensiuni in m
2		0181-200	150 x 100		0181-234	300 x 200
		0181-218	200 x 130		0181-242	500 x 330
		0181-226	250 x 160			

0182-... ECHER DREPT CU TALPA conform DIN 875/1

Executie: din otel inoxidabil

RG	Pret brut	Art. Nr.	Dimensiuni in mm	Pret brut	Art. Nr.	Dimensiuni in m
2		0182-206	150 x 100		0182-231	300 x 200
		0182-214	200 x 130		0182-249	500 x 330
		0182-222	250 x 160			

0234-... ECHER DREPT FIN conform DIN 875/00

Executie: din otel inoxidabil

RG	Pret brut	Art. Nr.	Dimensiuni in mm	Pret brut	Art. Nr.	Dimensiuni in m
2		0234-109	75 x 50		0234-125	150 x 100
		0234-117	100 x 70		0234-133	200 x 130

Alte mijloace de masurare cu certificat de verificare la cerere !

I Cu certificat de verificare conform ISO 9000

cu capat protector



I cu certificat de verificare conform ISO 9000

fara capat protector



I cu certificat de verificare conform ISO 9000

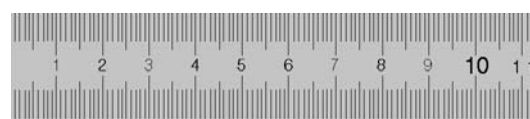

I cu certificat de verificare conform ISO 9000

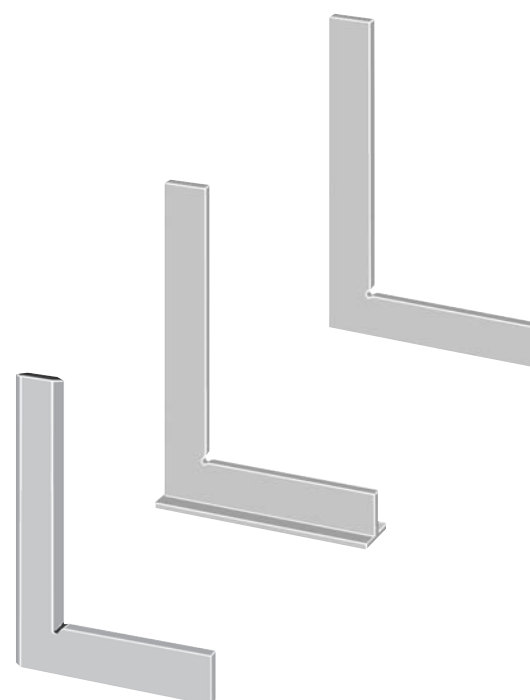

I Cu certificat de verificare conform ISO 9000

5512-... SUBLERE DE BUZUNAR DIGITALE »DIGIMAX-SUPERSICHT«

Digimax-Supersicht (afisaj ultra)

Cu cifre foarte mari;
Art. Nr. 5512-212,
Art. Nr. 5512-263,
Art. Nr. 5512-271
si cu masurator
de cote circulare de
adancime, 1,5 mm Ø,
ideal ptr gauri mici;
Art. Nr. 5512-069

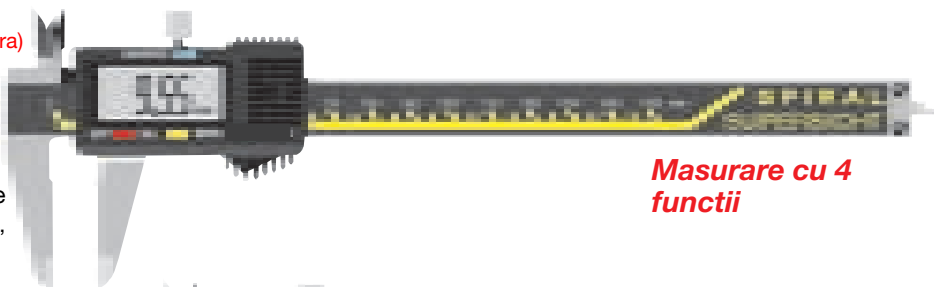

Masurare cu 4 functii

Executie:
cu varfuri stea pentru
masurare interioara, varfuri
de cutite, masurare in
adancime si scala mm/tol;
afisaj electronic-LCD al
datelor, comutare din mm/
tol, punctul zero reglabil
arbitrar; se livreaza in caseta

Digimax-Supersicht-Hold

Cu functie de hold (retinere) ptr
memorarea valorii masurate

Art. Nr. 5512-221

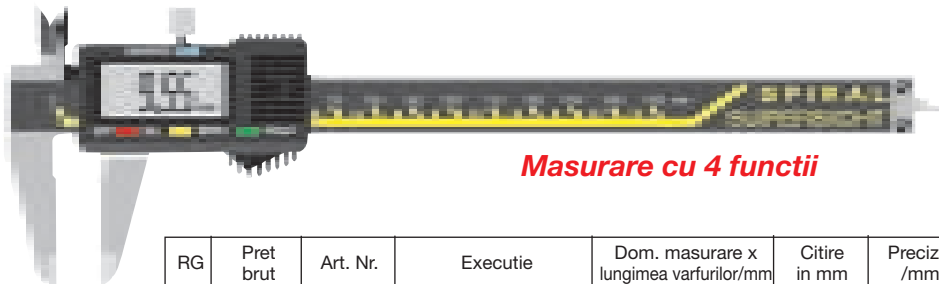

Masurare cu 4 functii

Toate uneltele »Supersicht« au cifre de 11 mm



RG	Pret brut	Art. Nr.	Executie	Dom. masurare x lungimea varfurilor/mm	Citire in mm	Precizie /mm	Precizia de repetare./mm
141		5512-212	Digimax-Supersicht	155 x 40	0,01	+/- 0,02	0,01
		5512-069	Cu masurator circular de adancime 1,5 mm Ø	155 x 40	0,01	+/- 0,02	0,01
		5512-221	Digimax-Supersicht cu functie-Hold	155 x 40	0,01	+/- 0,02	0,01
		5512-263	Digimax-Supersicht	200 x 50	0,01	+/- 0,02	0,01
		5512-271	Digimax-Supersicht	300 x 55	0,01	+/- 0,02	0,01

5512-... »DIGIMAX« SUBLERE DE BUZUNAR DIGITALE si pentru medii umede

Executie IP 54

Protejate impotriva prafului si apei : ideal de ex. in mediu de ceata, de racire

Executia IP 67

Protejate impotriva prafului si apei si ptr conditii extreme

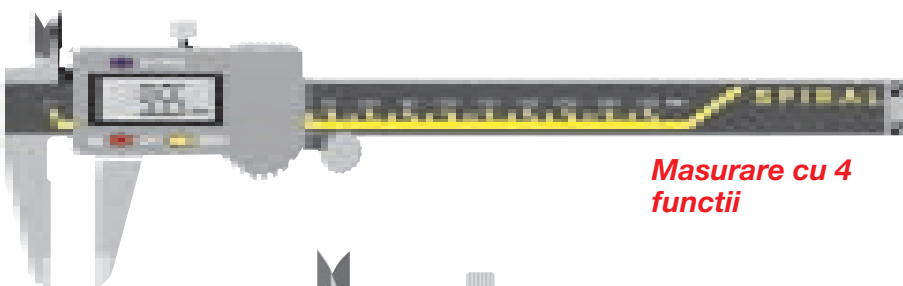

Masurare cu 4 functii

Executie:
cu varfuri stea pentru
masurare interioara, varfuri
de cutite, masurare in
adancime si scala mm/tol;
afisaj electronic-LCD,
comutare din mm/tol,
punctul zero reglabil arbitrar; se livreaza in caseta

Executia IP 67

Protejate impotriva prafului si apei si ptr conditii extreme !

Nou



Masurare cu 4 functii

Toate uneltele »Supersicht« au cifre de 11 mm



RG	Pret brut	Art. Nr.	Executie	Dom. masurare x lungimea varfurilor/mm	Citire in mm	Precizie /mm	Precizie de repetare./mm
141		5512-255	Digimax-Bestsicht protejat impotriva prafului si apei IP 54	155 x 40	0,01	+/- 0,02	0,01
		5512-298	Digimax-Supersicht etans la praf si la apa IP 67	155 x 40	0,01	+/- 0,02	0,01

Nou !

Multe sublere cu masurari cu 4 functii

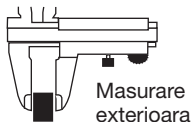
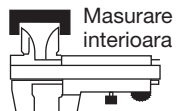

5512-... SUBLERE DE BUZUNAR DIGITALE »DIGIMAX-BESTSICHT«



Masurari cu 4 functii

Digimax-Bestsicht cu cifre foarte mari (extra) si ghidaj prismatic cu 4 functii ptr rulare usoara;
Art. Nr. 5512-204

Executie:

cu varfuri stea pentru masurare interioara, varfuri de cutite, masurare in adancime si scala mm/tol; afisaj electronic-LCD al datelor, comutare din mm/tol, punctul zero reglabil arbitrar; se livreaza in cuteta

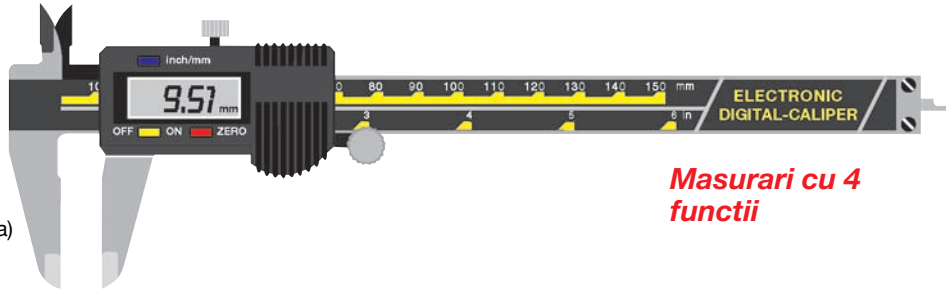

Masurari cu 4 functii

Digimax-Bestsicht
Cu cifre foarte mari (extra)

Art. Nr. 5512-051
Art. Nr. 5512-123

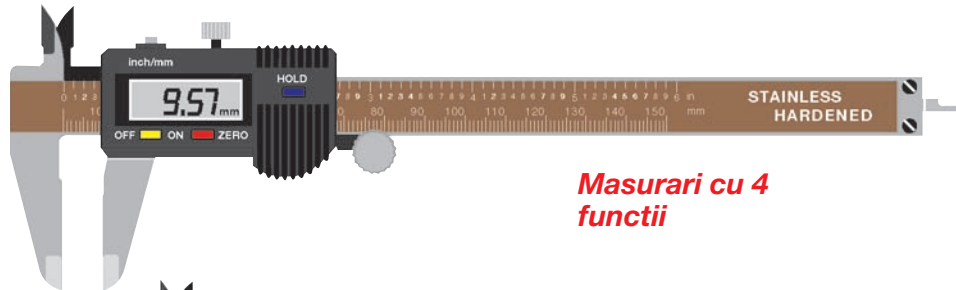

Masurari cu 4 functii

Digimax-Bestsicht-Hold
Cu functie hold (retinere)

Pentru inregistrarea valorii masurate
Art. Nr. 5512-140
Art. Nr. 5512-158

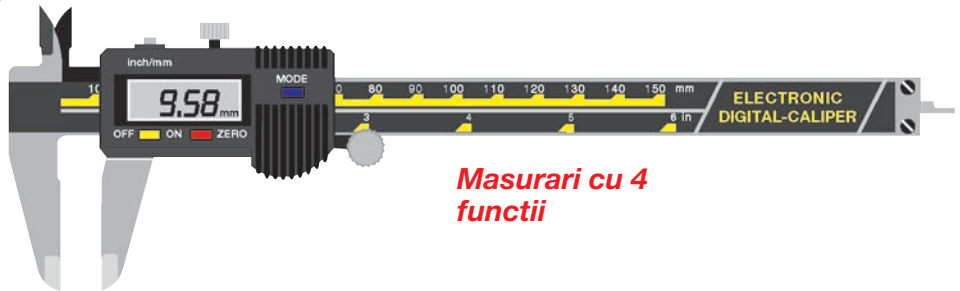

Masurari cu 4 functii

Digimax-Bestsicht-Mode cu functie mode ptr masurari de diferenta (Minimum/Maximum)

Art. Nr. 5512-166

Toate instrumentele »Bestsicht« cu cifre de 7,5 mm

Avantajele tuturor sublerelor digitale de buzunar Digimax-Digital:
Masurare rapida, fara erori
Precizie maxima
Viteza maxima de procesare
Masuri diferentiale (Mode type)

RG	Pret brut	Art. Nr.	Executie	Dom. de masurare x unghimea varfurilor/mm	Citire in mm	Precizie /mm	Precizie de repetare./mm	
141		5512-204	Digimax-Bestsicht cu ghidaj prismatic	155 x 40	0,01	+/- 0,02	0,01	
		5512-051	Digimax-Bestsicht	155 x 40	0,01	+/- 0,02	0,01	
		5512-123		155 x 40*	0,01	+/- 0,02	0,01	
		5512-140	Digimax-Bestsicht cu functie-Hold	155 x 40	0,01	+/- 0,02	0,01	
		5512-158		200 x 50	0,01	+/- 0,02	0,01	
		5512-166	Digimax-Bestsicht cu functie-Mode	155 x 40	0,01	+/- 0,02	0,01	
		5512-042	Standard	155 x 40*	0,01	+/- 0,02	0,01	
		Digimax-Bestsicht cu certificat de verificare conform DIN 862 conform ISO 9000						
		5512-107	cu functie-Hold	155 x 40	0,01	+/- 0,02	0,01	

* fara functie senzoriala

5510-... INTERFATA pentru toate instrumente digitale de masurat »MAXIMA-DIGIMAX«

pentru transmiterea datelor catre PC

Maxima-Interface prin cablul de legatura de la mijlocul de masurare la PC:
Art. Nr. 5510-104, pret brut.

RG 141

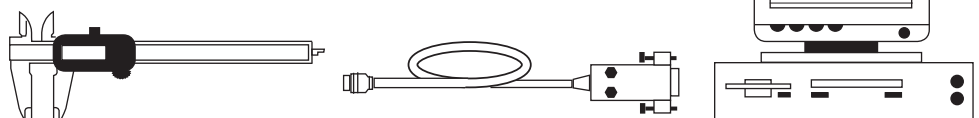

0192-... SUBLER DIGITAL PENTRU ATELIER »MAXIMA«

Executie: oțel inoxidabil, cromat, afișaj electronic LCD, comutare mm/tol, punctul zero se poate stabili arbitrar; cu reglaj fin și varfuri de cutit; se livrează în caseta

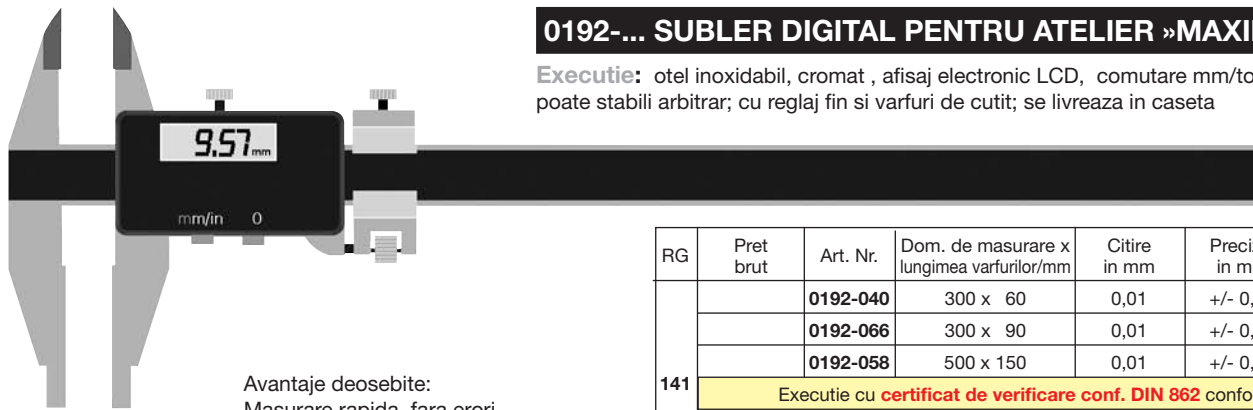

Avantaje deosebite:
Masurare rapida, fara erori
Precizie maxima
Viteza maxima de procesare

RG	Pret brut	Art. Nr.	Dom. de masurare x lungimea varfurilor/mm	Citire in mm	Precizie in mm	Precizie de repetare/mm
141		0192-040	300 x 60	0,01	+/- 0,04	0,01
		0192-066	300 x 90	0,01	+/- 0,04	0,01
		0192-058	500 x 150	0,01	+/- 0,04	0,01
	Executie cu certificat de verificare conf. DIN 862 conform ISO 9000					
		0192-104	300 x 90	0,01	+/- 0,04	0,01
		0192-112	500 x 150	0,01	+/- 0,04	0,01

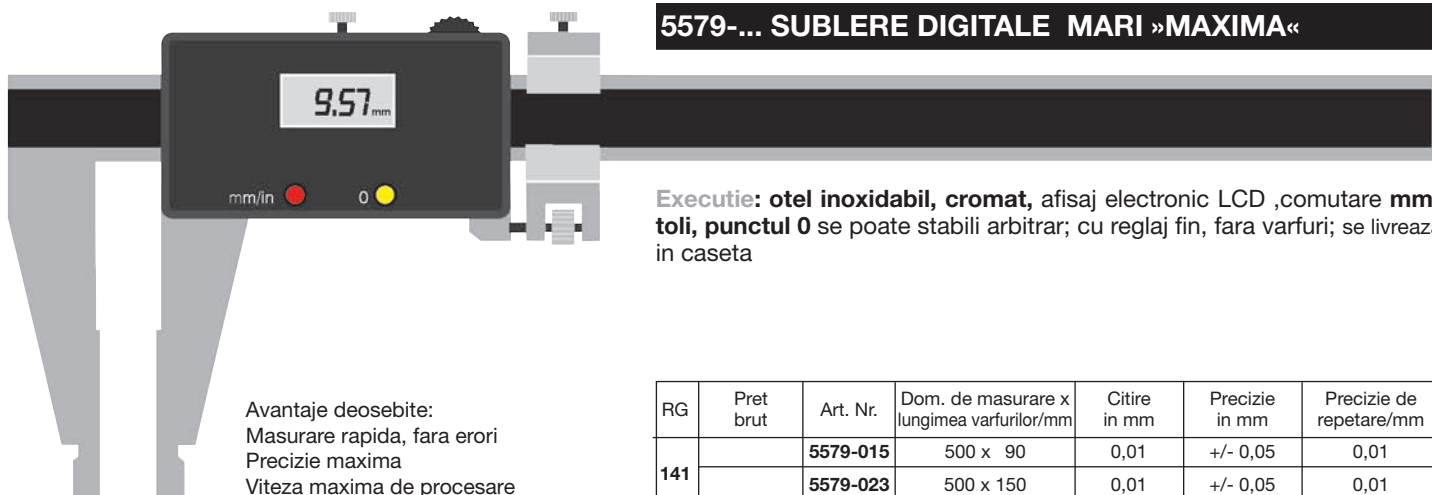

579-... SUBLERE DIGITALE MARI »MAXIMA«

Executie: oțel inoxidabil, cromat, afișaj electronic LCD, comutare mm/toli, punctul 0 se poate stabili arbitrar; cu reglaj fin, fara varfuri; se livrează în caseta

Avantaje deosebite:
Masurare rapida, fara erori
Precizie maxima
Viteza maxima de procesare

RG	Pret brut	Art. Nr.	Dom. de masurare x lungimea varfurilor/mm	Citire in mm	Precizie in mm	Precizie de repetare/mm
141		579-015	500 x 90	0,01	+/- 0,05	0,01
		579-023	500 x 150	0,01	+/- 0,05	0,01

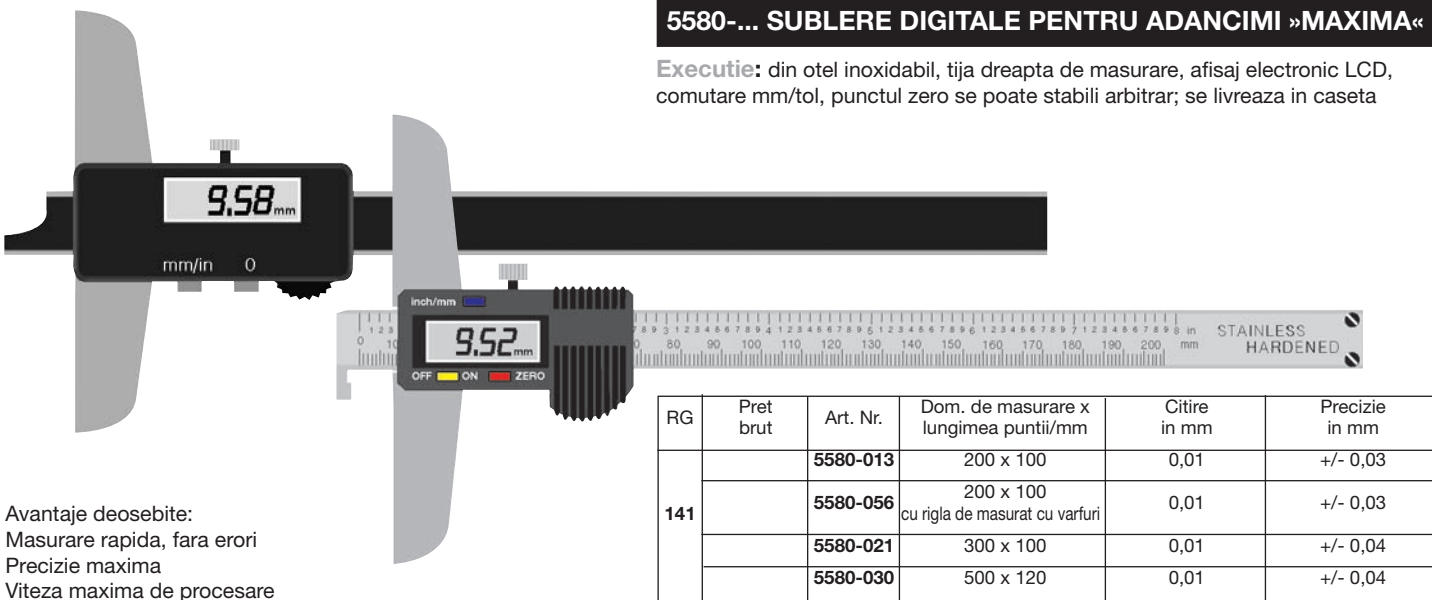

Avantaje deosebite:
Masurare rapida, fara erori
Precizie maxima
Viteza maxima de procesare

580-... SUBLERE DIGITALE PENTRU ADANCIMI »MAXIMA«

Executie: din oțel inoxidabil, tija dreapta de masurare, afișaj electronic LCD, comutare mm/tol, punctul zero se poate stabili arbitrar; se livrează în caseta

RG	Pret brut	Art. Nr.	Dom. de masurare x lungimea puntii/mm	Citire in mm	Precizie in mm
141		580-013	200 x 100	0,01	+/- 0,03
		580-056	200 x 100 cu rigla de masurat cu varfuri	0,01	+/- 0,03
		580-021	300 x 100	0,01	+/- 0,04
		580-030	500 x 120	0,01	+/- 0,04

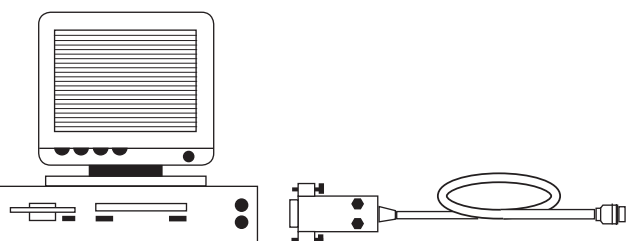

5510-... INTERFATA pt. toate instrumentele de masurat electronice-digitale »MAXIMA-DIGIMAX«

pentru transferul de date catre PC



Maxima-Interface
prin cablu de legatura
de la aparat la PC:
Art. Nr. 5510-104, pret brut RG 141

5581-... MICROMETRU-DIGITAL »MAXIMA«

Executie: suprafete de masurare din carburi (fus-Ø 6,5 mm), levier de blocare, etrier termoprotector; afisaj electronic LCD cu iesire a datelor (output), comutare mm/tol, punctul zero se poate stabili arbitrar; se livreaza in casete de lemn

RG	Pret brut	Art. Nr.	Dom. de masurare/mm	Citire/mm	Precizie/mm
141		5581-010	0 - 25	0,001	+/- 0,002
		5581-028	25 - 50	0,001	+/- 0,002
	protejat impotriva apei, IP 54, cu 2 afisaje LCD				
		5581-109	0 - 25	0,001	+/- 0,002

I Cu 2 afisaje LCD, in fata in mod obisnuit, precum si in spate, rotabil cu 180° = lizibilitate optima si in locuri neaccesibile



cu palpator



cu tambur de frictiune

Protectie impotriva apei, ideal ptr masurare in ceata de ulei

5515-.../5548-... COMPARATOARE DIGITALE »MAXIMA-DIGIMAX«

Executie: canal de fixare 8 mm, in caseta
Afisaj electronic LCD, lizibil, cifre mari
Iesire date, punctul zero se poate stabili arbitrar
comutare mm/tol

Precizie maxima – fara erori

Art. Nr 5515-122 suplimentar:

I masurare normala, masurare **Minim/Maxim**, masurare diferenta

I tasta de retinere a valorii masurate, declansator fixabil, 3 seturi de accesorii de masurare de schimb

Art. Nr 5548-012 (fara foto) citire 1/1000 mm, fara output de date;

RG	Pret brut	Art. Nr.	Dom. masurare in mm	Citire in mm	Precizie/mm (precizie de repetare/mm)	Dim. in mm
		5515-122	0 - 10	0,01	+/- 0,02 (0,01)	ca. 60 Ø
141		5515-114	0 - 25	0,01	+/- 0,02 (0,01)	ca. 60 x 155
		5548-012	0 - 25	0,001	+/- 0,002 (0,001)	ca. 71 x 140

I citire 0,01
I iesire date

cu declansator reglabil
3 seturi de accesorii de masurare de schimb (normal, plat, sfera)



Foto Art. Nr. 5515-122

5583-... INSTRUMENTE DIGITALE PENTRU MASURAREA INALTIMII »MAXIMA-DIGIMAX«

Executie: constructie stabila din material de fonta; in cutie din polistiren

Avantaje : Afisaj electronic LCD, valoare presetata (cu limite + si -), punctul zero se poate stabili arbitrar, comutare mm/tol, tasta de retinere a valorii masurate

RG	Pret brut	Art. Nr.	Dom. de mas./mm	Citire mm / tol	Precizie/mm
		5583-012	0 - 300	0,01 / 0,005	+/- 0,04
		5583-021	0 - 500	0,01 / 0,005	+/- 0,05
141	ace de trasat de schimb				
		5583-055	pentru »Digi-Max 300« – Art. Nr. 5583-012		
		5583-063	pentru »Digi-Max 500« – Art. Nr. 5583-021		

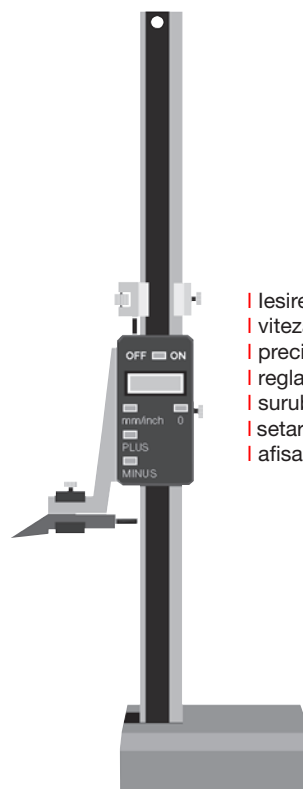

I iesire date RS 232
I viteza maxima de procesare
I precizie maxima
I reglaj fin
I surub de fixare
I setare – preset (=valoarea limita + / -)
I afisare-LCD electronica

0119-... MASURATOR DIGITAL - PENTRU GROSIMI »MAXIMA«

Executie: suprafete de masurare de carburi (10 mm Ø), afisaj electronic LCD, comutare mm/toli, punctul zero se poate alege arbitrar, in husa.

Utilizare: ptr masuratori absolute, relative si de toleranta

Avantaje deosebite: masurare rapida, fara erori

Precizie maxima

RG	Pret brut	Art. Nr.	Dom. de mas. in mm	Citire in mm	Precizie in mm	Adancimea lerei in mm
141		0119-211	0 - 25	0,01	+/- 0,02	25



0101-.../0102-... SUBLERE DE PRECIZIE DE BUZUNAR, INOXIDABILE

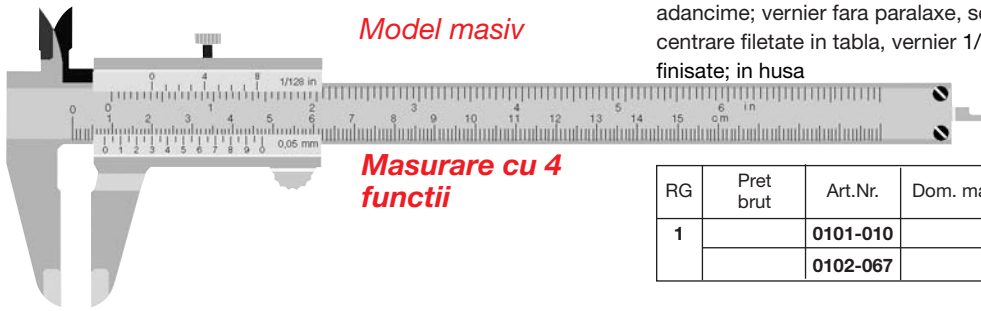

Model masiv

Masurare cu 4 functii

Executie: din otel inoxidabil, cu varfuri in cruce, surub de fixare si tije de adancime; vernier fara paralaxe, scale de masurare cromate si calite, cu gauri de centrare filetate in tabla, vernier 1/20 extins pe 39mm, ghidajele deosebit de finisate; in husa

RG	Pret brut	Art.Nr.	Dom. masurare x lung.varfurilor/ mm	Precizie
1		0101-010	155 x 40	1/20 mm
		0102-067	200 x 45	1/128 tol

NOU: multe sublere cu masurare cu 4 functii

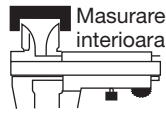

Masurare interioara

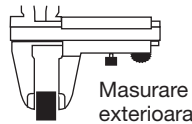

Masurare exterioara



Masurare adancime



Masuratori pana la limitator, trasare

0102-.../0103-... SUBLERE DE PRECIZIE DE BUZUNAR, INOXIDABILE »MAXUI«

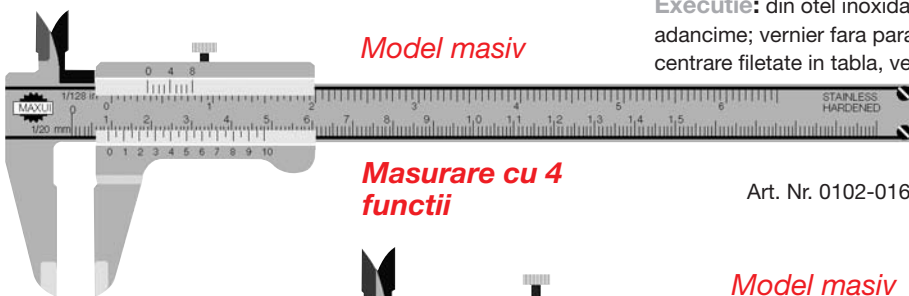

Model masiv

Masurare cu 4 functii

Executie: din otel inoxidabil, cu varfuri in cruce, surub de fixare si tije de adancime; vernier fara paralaxe, scale de masurare cromate si calite, cu gauri de centrare filetate in tabla, vernier 1/20 extins pe 39mm, ghidajele deosebit de finisate; in husa

Art. Nr. 0102-016

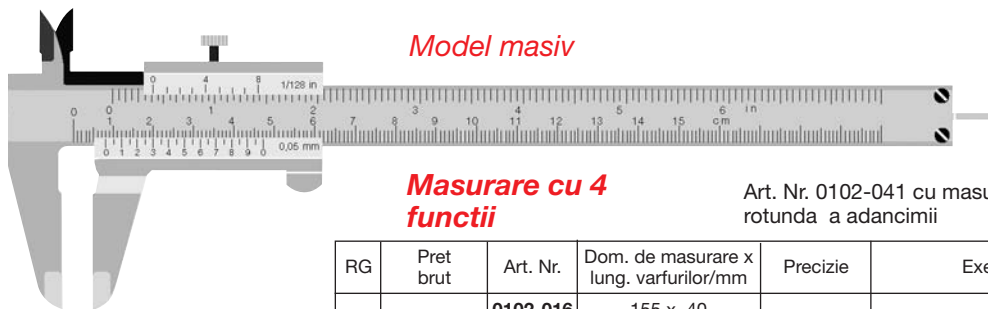

Model masiv

Masurare cu 4 functii

Art. Nr. 0102-041 cu masurarea rotunda a adancimii

RG	Pret brut	Art. Nr.	Dom. de masurare x lung. varfurilor/mm	Precizie	Executie
1		0102-016	155 x 40	1/20 mm	cromat mat
		0102-024	200 x 50		
		0102-075	300 x 55	1/128	
		0102-041	155 x 40 tol		

Avantaje deosebite: rulaj fin prin ghidaje finisate si caneluri de degajare a murdariei, gradatii si serii pe scala negre – de aceea se poate citi bine

0120-... SUBLERE DE BUZUNAR FARA PARALAXE SI INOXIDABILE

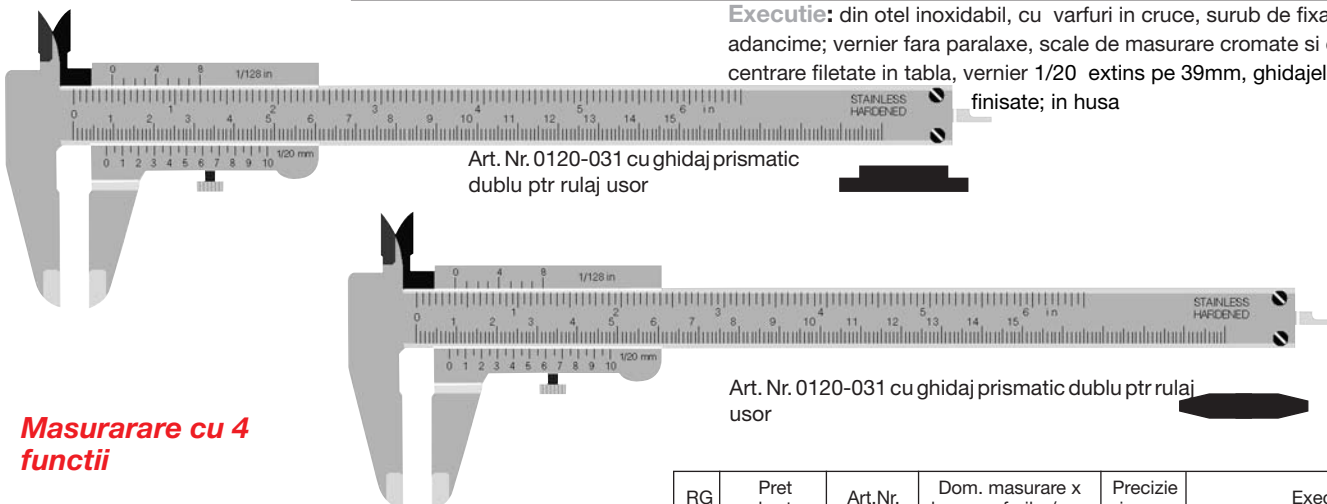

Executie: din otel inoxidabil, cu varfuri in cruce, surub de fixare si tije de adancime; vernier fara paralaxe, scale de masurare cromate si calite, cu gauri de centrare filetate in tabla, vernier 1/20 extins pe 39mm, ghidajele deosebit de finisate; in husa

Art. Nr. 0120-031 cu ghidaj prismatic dublu ptr rulaj usor

Art. Nr. 0120-031 cu ghidaj prismatic dublu ptr rulaj usor

Masurare cu 4 functii

Calitate superioara

RG	Pret brut	Art.Nr.	Dom. masurare x lung. varfurilor/mm	Precizie in mm	Executie
1		0120-014	155 x 40	1/20	cu ghidaj special
		0120-031	155 x 40	1/20	cu ghidaj prismatic dublu

0201-.../0102-.../0103-... SUBLERE DE BUZUNAR INOXIDABILE »MAXIMA«

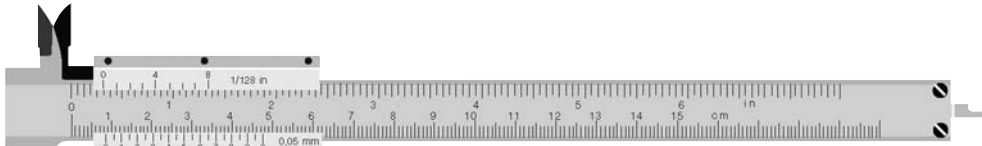

Masurare cu 4 functii

Art. Nr. 0201-022 si 0102-105

Executie conform DIN 862, otel i
noxidabil, cromat, in husa, cu varfuri
in cruce ptr masurari interioare, tai-
suri si tije de adancime, suprafete de
masurare calite



Masurare cu 4 functii

Art. Nr. 0102-059 si 0102-113

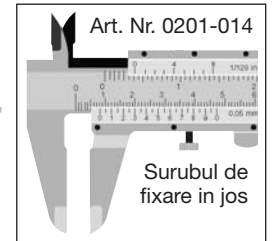

Art. Nr. 0201-014

Surubul de
fixare in jos

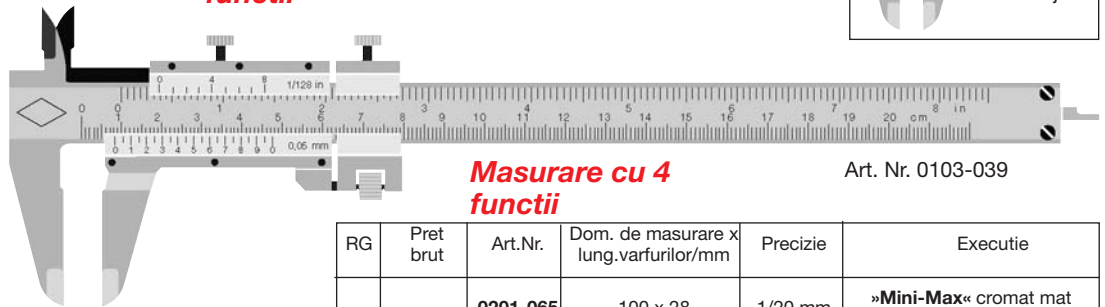

Masurare cu 4 functii

Art. Nr. 0103-039

Calitate superioara, pret avantajos

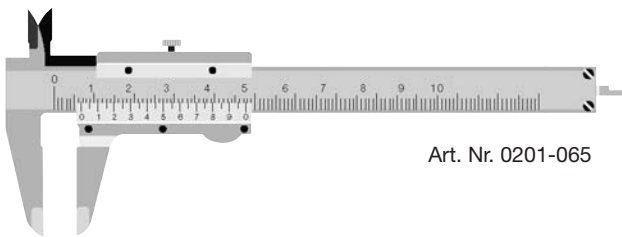

Art. Nr. 0201-065

RG	Pret brut	Art.Nr.	Dom. de masurare x lung.varfurilor/mm	Precizie	Executie
1		0201-065	100 x 28	1/20 mm	»Mini-Max« cromat mat cu surub de fixare
		0201-022	155 x 40	1/20 mm 1/128 tol	cromat mat, scala metrica si scala pt. toli , cu reglarea momentului
		0102-059	155 x 40	1/20 mm 1/128	cromat mat, scala metrica+ toli, cu surub de fixare sus
		0201-014	155 x 40	1/20 mm 1/128 tol	la fel ca sus, insa surubul de fixare este jos
		0102-067	200 x 45	1/20 mm 1/128 tol	cromat mat, scala metrica+ toli , cu surub de fixare sus
		0103-039	200 x 45	1/20 mm 1/128 tol	cromat mat, scala metrica si toli, surub de fixare si reglare fina; in caseta de lemn
		0103-021	200 x 50	1/50 mm 1/1000 tol	cu reglare fina
	Sublere de buzunar cu certificat de verificare conform ISO 9000				
		0102-105	155 x 40	1/20 mm	cu reglare a momentului
		0102-113	155 x 40	1/128 tol	cu surub de fixare
		0102-121	200 x 50	1/50 mm	cu surub de fixare

0202-... SET INSTRUMENTE DE MASURA »MAXIMA-KIT«, 4-componente

RG	Pret brut	Art. Nr.	Denumire
		0202-029	»Maxima-Kit« in caseta de plastic
Cuprins: »Maxima« subler de buzunar, dom. de masurare 150 mm, inoxidabil cromat, pentru masurare a varfurilor si a adancimii, cifrele scrise cu negru »Maxima« Micrometru: 0 - 25 mm, cromat, cu suprafete de masurat din metal dur si clichet fin senzorial; Maxima« echer de precizie: 100 x 70 mm, DIN 875; »Maxima« rigla de masurat de otel 150 mm Lungime, inoxidabila;			

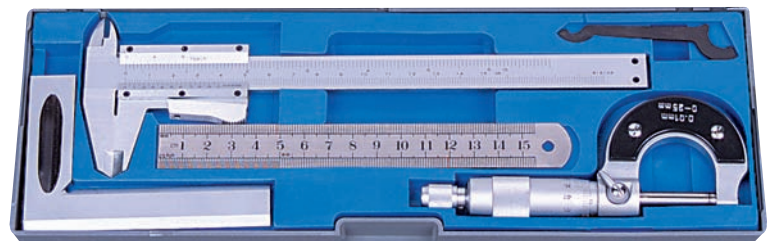

0104-...SUBLER DE BUZUNAR CU CEAS DE MASURARE »MAXIMA«

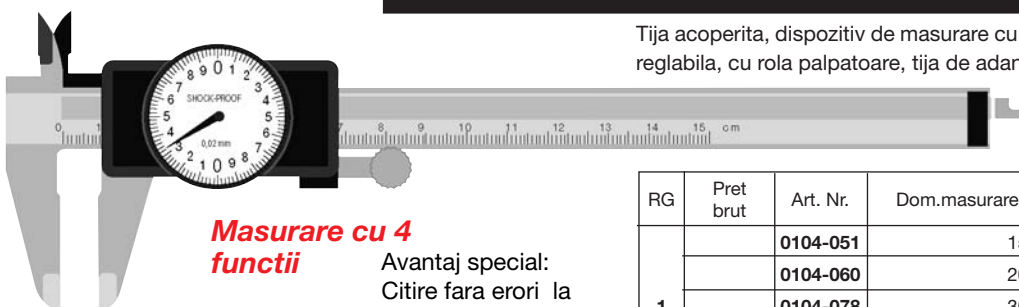

Masurare cu 4 functii

Avantaj special:
Citire fara erori la
masuratori de

Tija acoperita, dispozitiv de masurare cu protectie impotriva impactului, cu scala reglabila, cu rola palpatoare, tija de adancime, varfuri in cruce, in husa

RG	Pret brut	Art. Nr.	Dom.masurare x lung.varfurilor/mm	Precizie/mm
1		0104-051	150 x 40	0,02 (1/50)
		0104-060	200 x 50	
		0104-078	300 x 60	

SUBLERE DE PRECIZIE DE ATELIER PENTRU CONTROL conform DIN 862

Executie »A« = fara varfuri, cu reglaj fin; in cutie de lemn

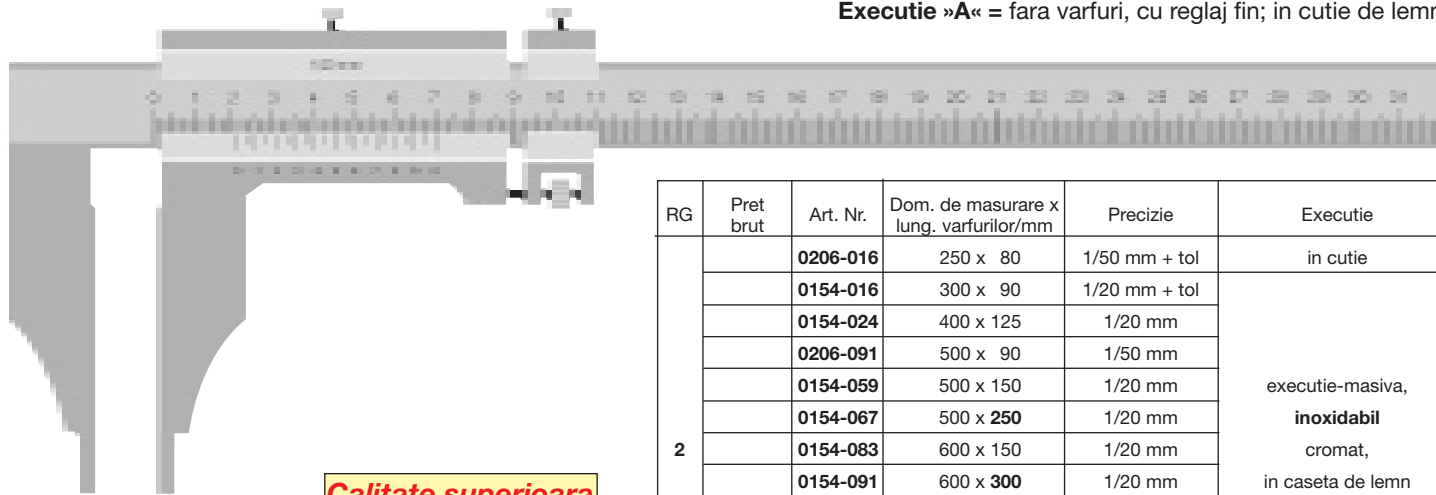

Calitate superioara

RG	Pret brut	Art. Nr.	Dom. de masurare x lung. varfurilor/mm	Precizie	Executie
2		0206-016	250 x 80	1/50 mm + tol	in cutie
		0154-016	300 x 90	1/20 mm + tol	executie-masiva, inoxidabil cromat, in caseta de lemn
		0154-024	400 x 125	1/20 mm	
		0206-091	500 x 90	1/50 mm	
		0154-059	500 x 150	1/20 mm	
		0154-067	500 x 250	1/20 mm	
		0154-083	600 x 150	1/20 mm	
		0154-091	600 x 300	1/20 mm	
		0154-105	800 x 150	1/20 mm	
		0206-105	1.000 x 125	1/50 mm	
		0154-121	1.000 x 150	1/20 mm	
	0206-113	1.500 x 200	1/50 mm		

SUBLERE DE PRECIZIE DE ATELIER PENTRU CONTROL conform DIN 862

Executie »B« = cu varfuri, fara reglaj fin; in caseta de lemn

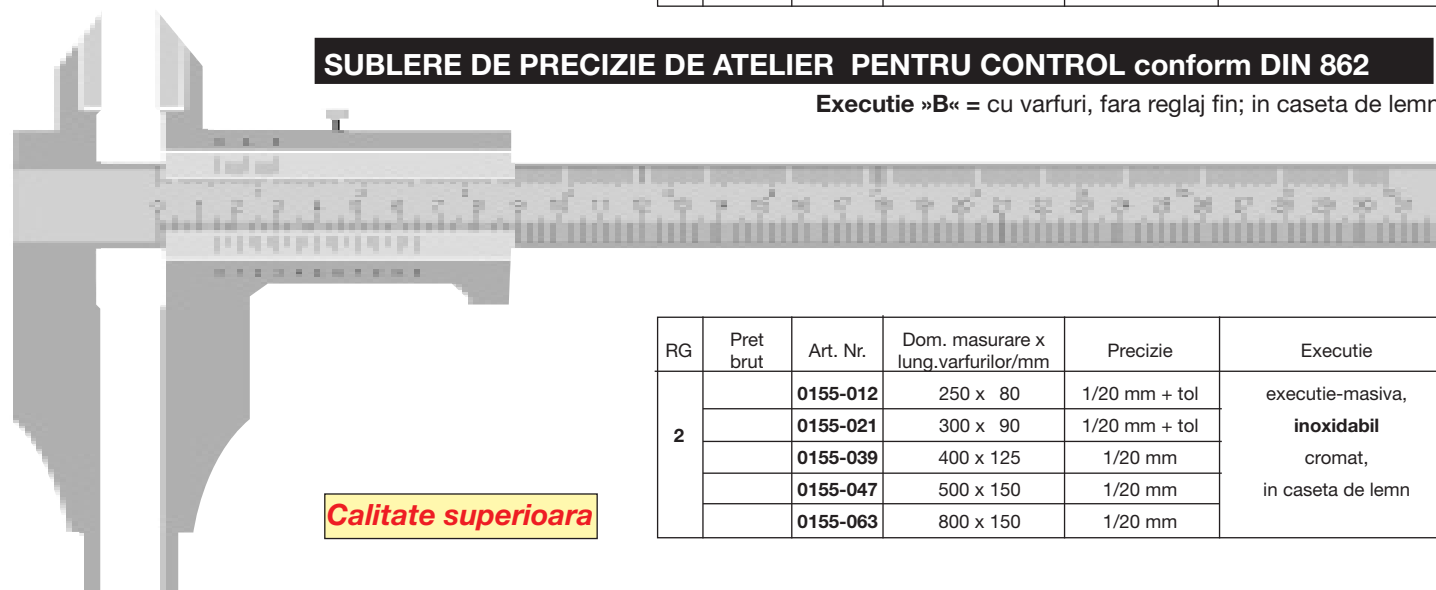

Calitate superioara

RG	Pret brut	Art. Nr.	Dom. masurare x lung.varfurilor/mm	Precizie	Executie
2		0155-012	250 x 80	1/20 mm + tol	executie-masiva, inoxidabil cromat, in caseta de lemn
		0155-021	300 x 90	1/20 mm + tol	
		0155-039	400 x 125	1/20 mm	
		0155-047	500 x 150	1/20 mm	
		0155-063	800 x 150	1/20 mm	

SUBLERE DE PRECIZIE DE ATELIER PENTRU CONTROL conform DIN 862

Executie »C« = cu varfuri, cu reglaj fin; in caseta de lemn

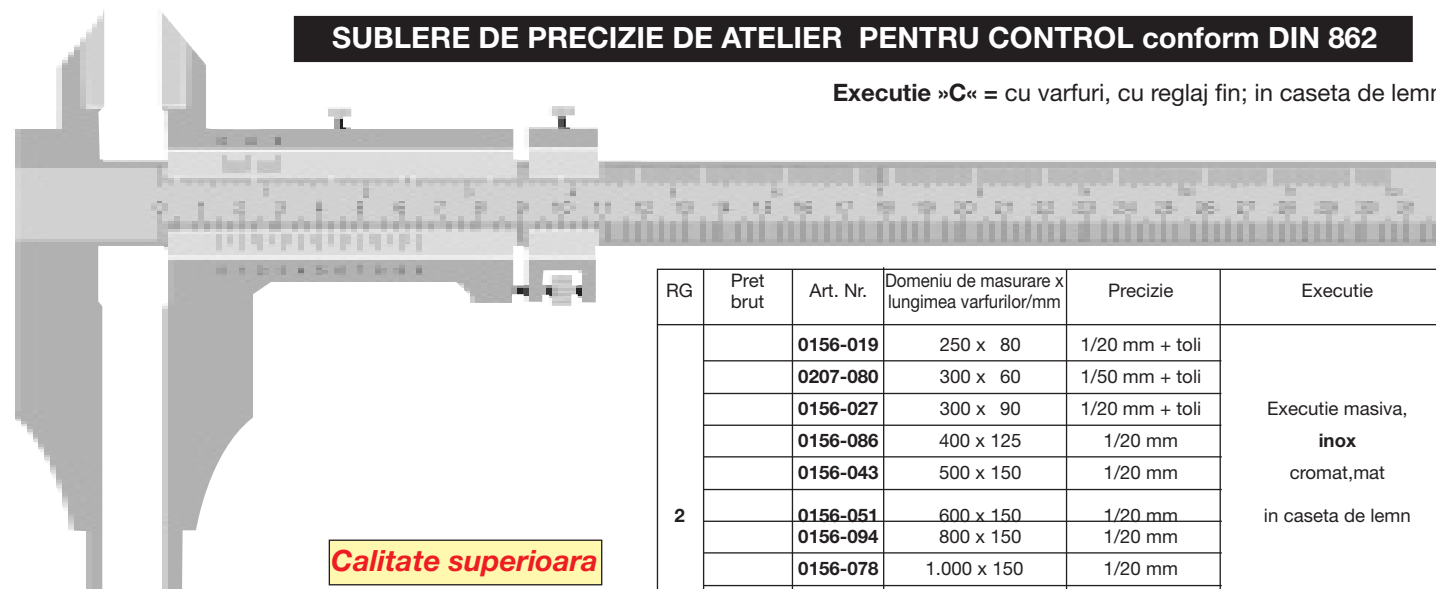

Calitate superioara

RG	Pret brut	Art. Nr.	Domeniu de masurare x lungimea varfurilor/mm	Precizie	Executie	
2		0156-019	250 x 80	1/20 mm + toli	Executie masiva, inox cromat,mat in caseta de lemn	
		0207-080	300 x 60	1/50 mm + toli		
		0156-027	300 x 90	1/20 mm + toli		
		0156-086	400 x 125	1/20 mm		
		0156-043	500 x 150	1/20 mm		
		0156-051	600 x 150	1/20 mm		
		0156-094	800 x 150	1/20 mm		
		0156-078	1.000 x 150	1/20 mm		
		0156-124	1.500 x 200	1/20 mm		
	Sublere de control cu certificat de verificare conform ISO 9000					
			0156-108	300 x 100	1/20 mm + toli	ca si sus
		0156-116	500 x 150	1/20 mm		

0211-... SUBLERE INOXIDABILE PENTRU TRASAT SI MASURARE RISC DE PIERDERE

Din otel inoxidabil, in caseta de plastic, cu varfuri de trasare special calite, scala si vernierul cromate, suprafetele de masurare calite si finisate.

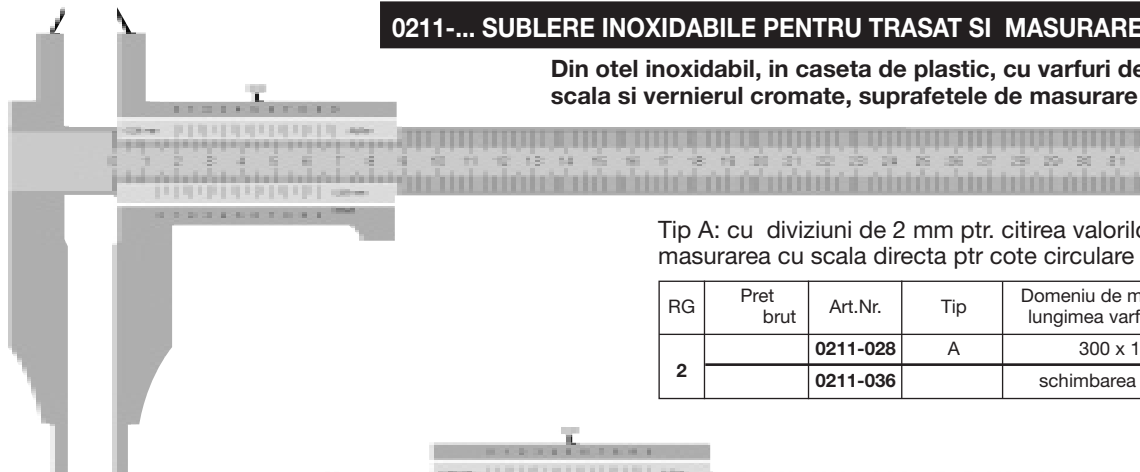

Tip A: cu diviziuni de 2 mm ptr. citirea valorilor interioare si exterioare (ptr masurarea cu scala directa ptr cote circulare – gauri)

RG	Pret brut	Art.Nr.	Tip	Domeniu de masurare x lungimea varfului / mm	Masa pierduta / %
2		0211-028	A	300 x 100	Impartire normala
		0211-036		schimbarea varfului	

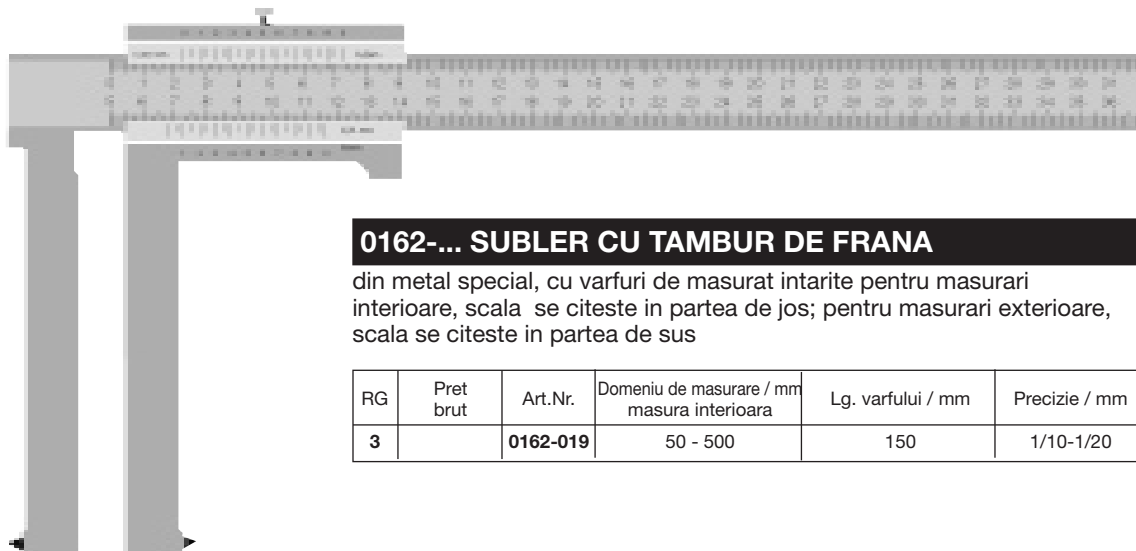

0162-... SUBLER CU TAMBUR DE FRANA

din metal special, cu varfuri de masurat intarite pentru masurari interioare, scala se citeste in partea de jos; pentru masurari exterioare, scala se citeste in partea de sus

RG	Pret brut	Art.Nr.	Domeniu de masurare / mm masura interioara	Lg. varfului / mm	Precizie / mm
3		0162-019	50 - 500	150	1/10-1/20

0210-... SUBLERE DE TRASARE DIN OTEL SPECIAL

din otel special cu varfuri de masurat intarite

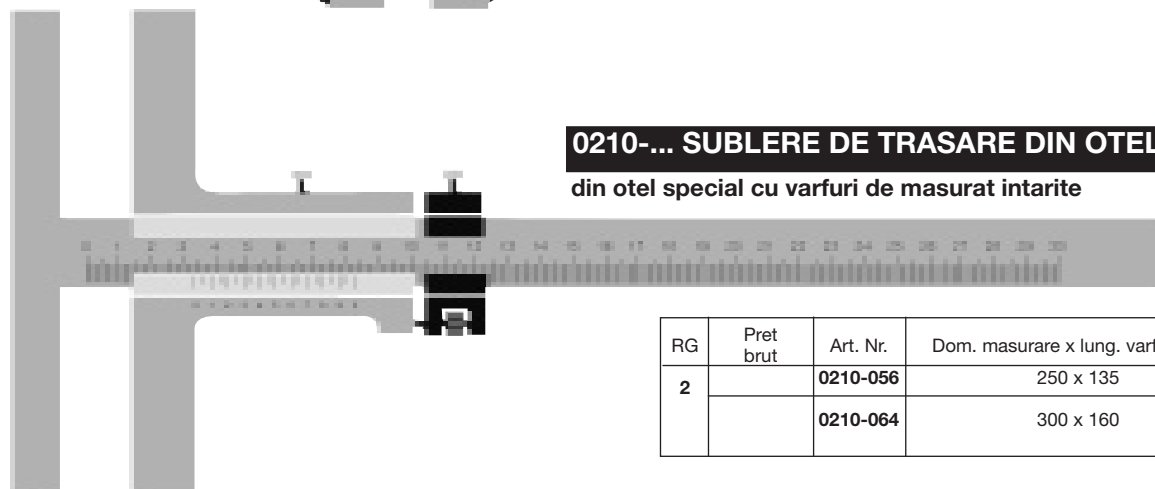

RG	Pret brut	Art. Nr.	Dom. masurare x lung. varfului/mm	Vernier/mm
2		0210-056	250 x 135	1/20
		0210-064	300 x 160	1/20

8625-...SUBLER CU CEAS »SECURITY«

Masurare 4 functii

Executie: din material plastic special inoxidabil cu proportie de 60% fibra de sticla; ghidaj cu cremaliera, dispozitiv de masurare cu protectie impotriva impactului cu scala reglabila , cu surub de fixare si rola de sesizare, varfuri in cruce si tija de adancime, in caseta



Nu este conductor, de aceea este ideal pentru electricieni!

RG	Pret brut	Art.Nr.	Dom. de masurare x lg. varfului/mm	citire in mm	Executie
1		8625-018	150 x 40	0,1	ghidare cu cremaliera

0163-... SUBLERE-COMPAS

Din otel special, in caseta de plastic, varfuri de trasare calite si finisate;
Utilizare: ptr. trasari precise paralele si circulare

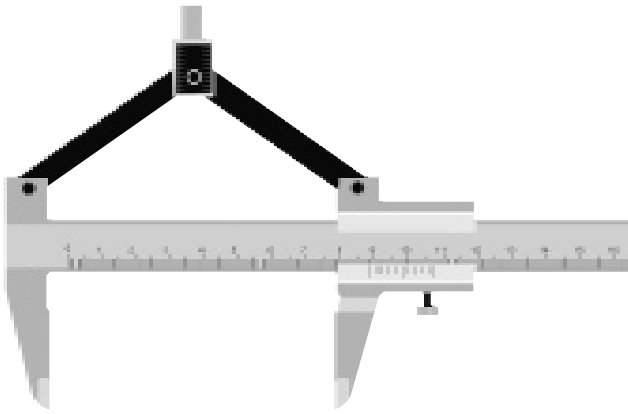

RG	Pret brut	Art.Nr.	Dom. de masurare x lg. varfului / mm	Precizie in mm	pentru trasare pana Ø / mm
3		0163-023	200 x 40	1/10	400
		0163-031	300 x 40	1/10	600

5505-...SUBLERE PTR CANALE INTERIOARE conform DIN 862

Din otel inoxidabil, in caseta din plastic, varfuri de masurare interioara in cruce, vernierul si scala cromate, suprafete de masurare calite si finisate

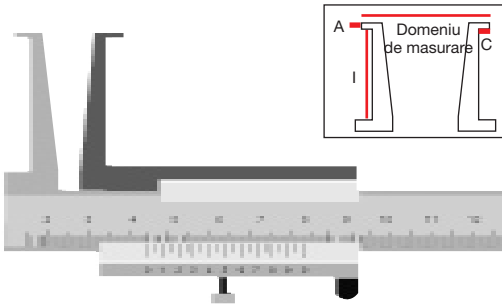

RG	Pret brut	Art.Nr.	Dom. de masurare / mm	Masuratori/mm I / A / C	Nonius / mm
2		5505-011	10 - 160	25 / 3 / 0,9	1/20
		5505-020	20 - 160	40 / 5 / 2,0	1/20
		5505-038	26 - 200	60 / 7 / 3,0	1/20

5593-... SUBLERE INOXIDABILE CU 3 PUNCTE

Din otel inoxidabil, cromat, in husa
Utilizare: ptr verificarea sculelor cu 3 lame

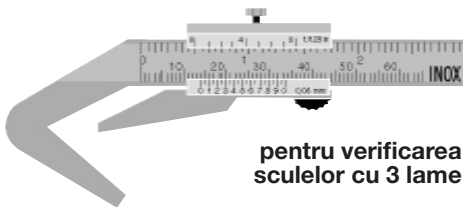

pentru verificarea
sculelor cu 3 lame

RG	Pret brut	Art.Nr.	Dom. masurare/mm	Executie
2		5593-018	4 - 40	Varfuri de masurat 60°

5580-...SUBLER DE ADANCIME-DIGITAL »MAXIMA«

Executie: din otel inoxidabil; rigla de masurat dreapta, afisaj electronic LCD, comutator mm/tol, punctul zero reglabil arbitrar; in caseta de lemn

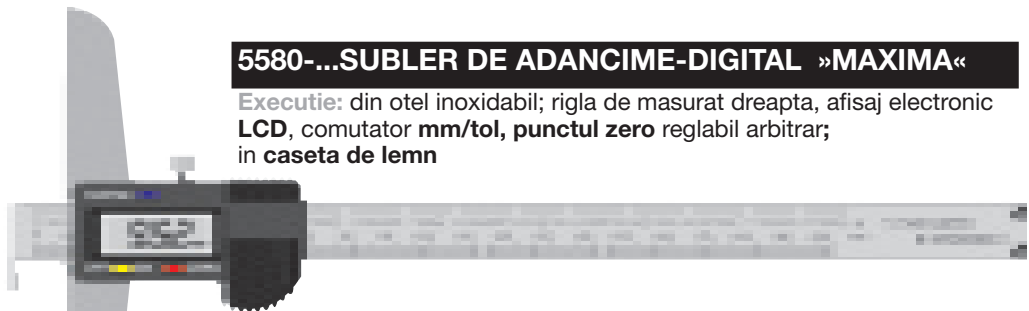
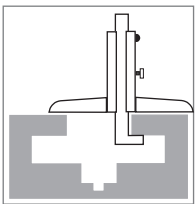

RG	Pret brut	Art. Nr.	Dom. masurare x latimea puntii/mm	Citire in mm	Precizie in mm
141		5580-013	200 x 100	0,01	+/- 0,03
		5580-056	200 x 100 cu rigla de masurat-cu varf	0,01	+/- 0,03
		5580-021	300 x 100	0,01	+/- 0,04
		5580-030	500 x 120	0,01	+/- 0,04

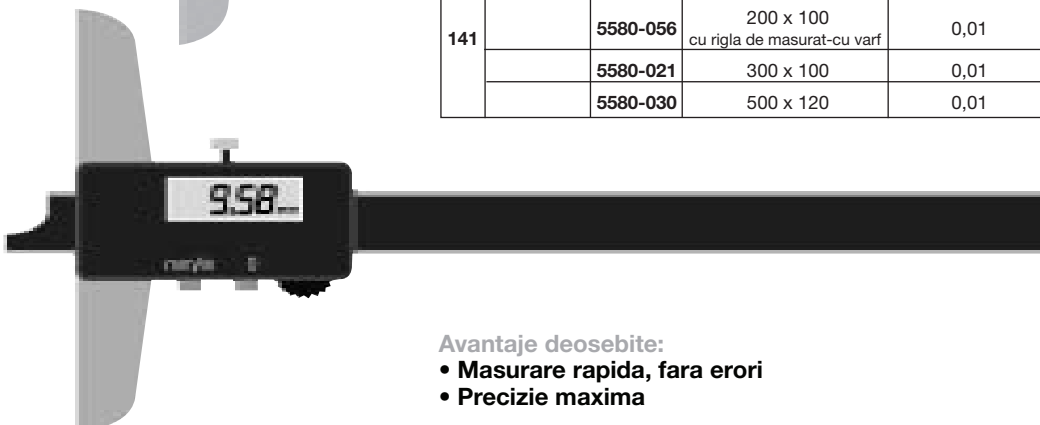
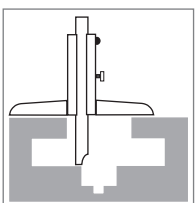

Avantaje deosebite:

- Masurare rapida, fara erori
- Precizie maxima

0106-...SUBLER DE PRECIZIE DE ADANCIME INOXIDABIL »MAXIMA«

din otel inoxidabil, in husa, tija de masurare dreapta, scala cu cifre **ingrosate cu negru**, suprafetele de masurare calite si finisate

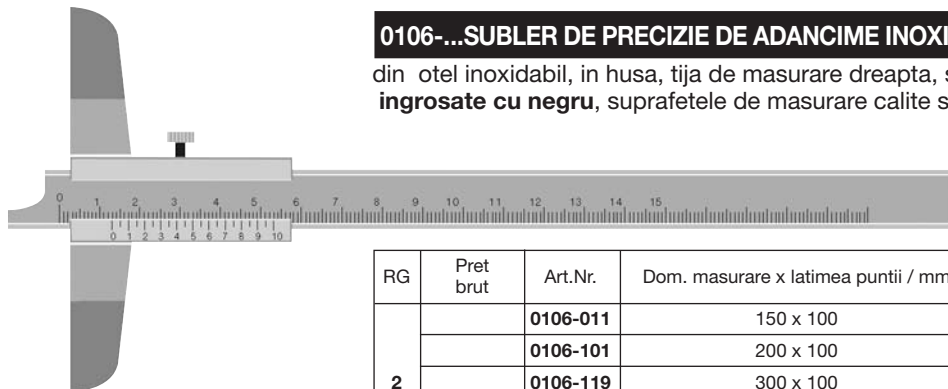
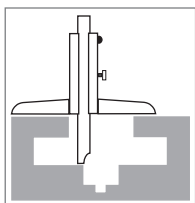

RG	Pret brut	Art.Nr.	Dom. masurare x latimea puntii / mm	Precizie / mm
2		0106-011	150 x 100	1/20
		0106-101	200 x 100	1/20
		0106-119	300 x 100	1/20
		0106-135	400 x 150	1/20
		0106-127	500 x 150	1/20

0299-... SUBLER DE PRECIZIE DE ADANCIME INOXIDABIL

Din otel inoxidabil, in husa, cu tija de masurare, scala si vernierul cromate, Suprafetele de masurare calite si finisate

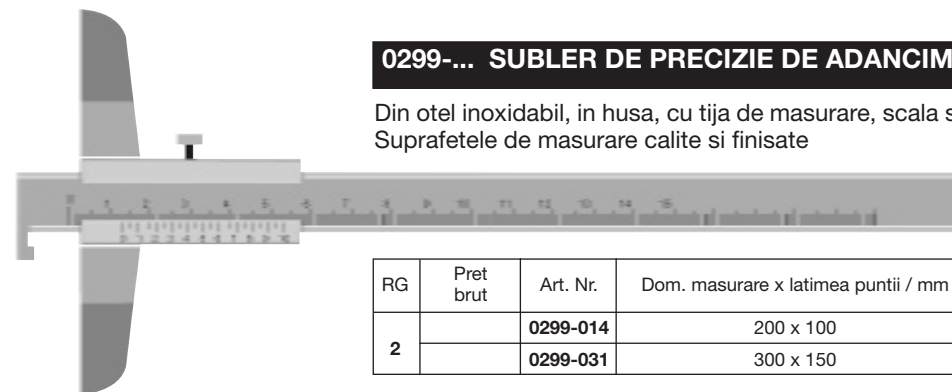
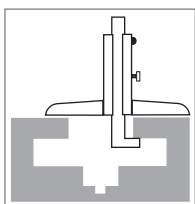

RG	Pret brut	Art. Nr.	Dom. masurare x latimea puntii / mm	Precizie / mm
2		0299-014	200 x 100	1/20
		0299-031	300 x 150	1/20

0195-... SUBLER DE ADANCIME INOXIDABIL cu tija de masurare

Din otel inoxidabil, in husa, cu varf de masurare calit, scala si vernierul cromate, suprafetele de masurare calite si finisate

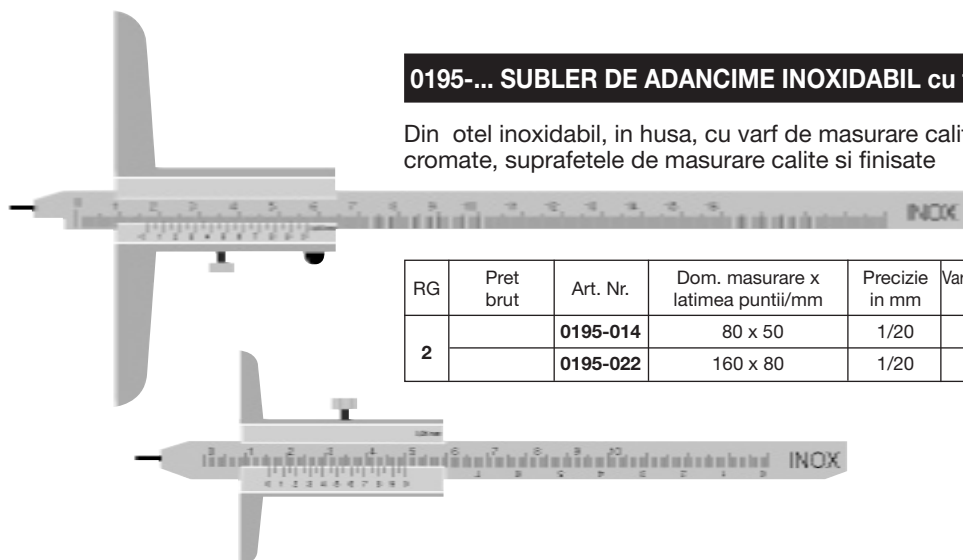
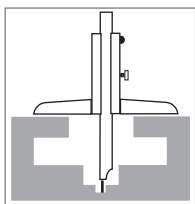

RG	Pret brut	Art. Nr.	Dom. masurare x latimea puntii/mm	Precizie in mm	Varf masurare-Ø lg./mm	Sina masurare in mm
2		0195-014	80 x 50	1/20	1 x 8	8 x 3
		0195-022	160 x 80	1/20	1,5 x 8	8 x 3

0299-... SUBLER DE PRECIZIE DE ADANCIME SI DE GROSIME

Cu tija de masurare reglabila, suprafete calite si finisate

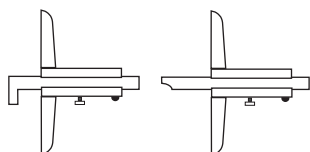
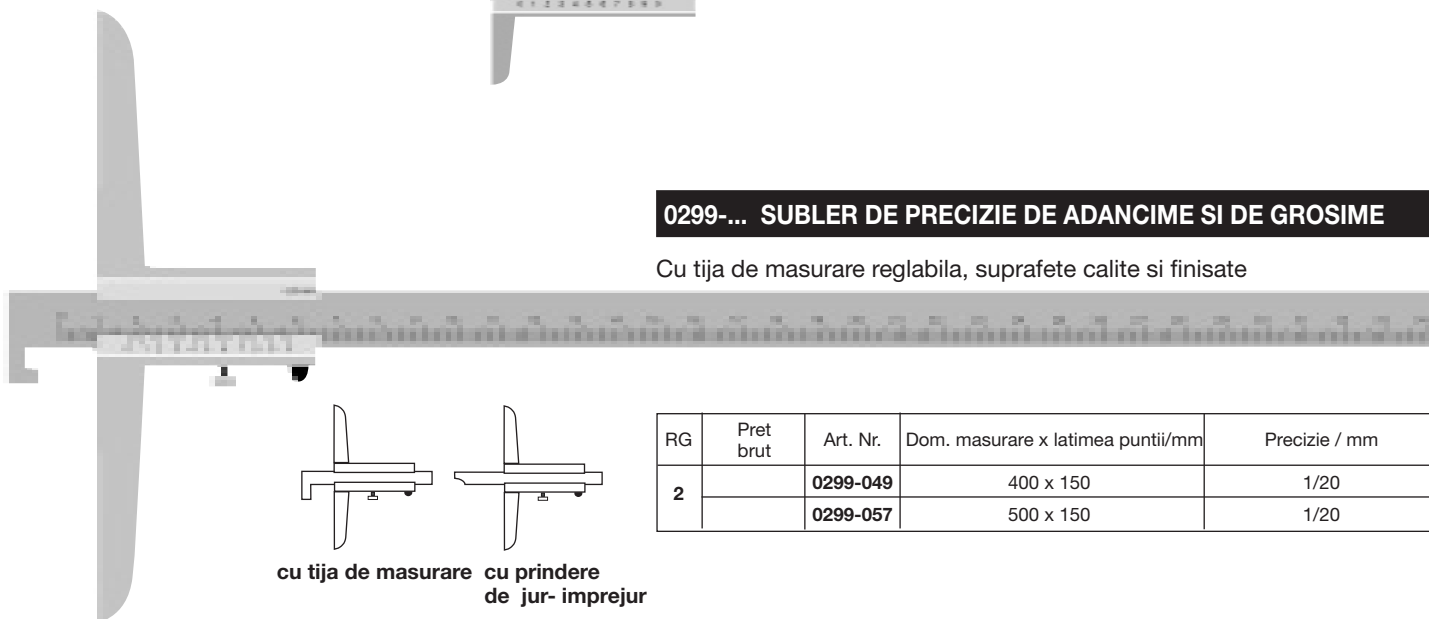

cu tija de masurare cu prindere de jur-imprejur

RG	Pret brut	Art. Nr.	Dom. masurare x latimea puntii/mm	Precizie / mm
2		0299-049	400 x 150	1/20
		0299-057	500 x 150	1/20

Suprafete de masurare din carburi

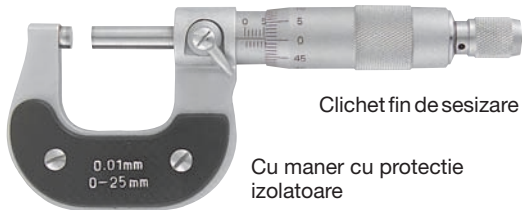

Clichet fin de sesizare

Cu maner cu protectie izolatoare

Pe tamburul de masurare cu diviziune de 50 (0,5 mm pasul fusului), se adauga valorile de 1/2 mm; Distantele mari intre liniile intermediare permit o estimare comoda a valorilor intermediare; 2 rotatii = 1 mm

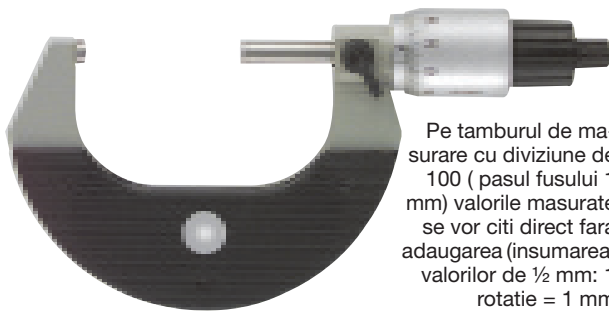

Pe tamburul de masurare cu diviziune de 100 (pasul fusului 1 mm) valorile masurate se vor citi direct fara adaugarea (insumarea) valorilor de 1/2 mm: 1 rotatie = 1 mm



fara micrometru

0111-.../0110-... MICROMETRU DE PRECIZIE »MAXIMA« conform DIN 863/1

Executie: cu suprafete din carburi, clema de fixare si clichet de sesizare, pasul filetelui 0,5 mm, fus Ø 6,35 mm, tambur de masurare Ø 18 mm, tamburul de masurare cromat, in caseta;

RG	Pret brut	Art. Nr.	Dom. masurare/ mm	Pret brut	Art. Nr.	Dom. masurare/ mm
1		0111-104	0 - 25		0110-078	150 - 175
		0111-112	25 - 50		0110-086	175 - 200
		0111-121	50 - 75		0110-094	200 - 225
		0111-139	75 - 100		0110-108	225 - 250
		0111-147	100 - 125		0110-116	250 - 275
		0111-155	125 - 150		0110-124	275 - 300
Micrometru de precizie cu certificat de verificare conform ISO 9000						
		0110-205	0 - 25		0110-221	50 - 75
		0110-213	25 - 50		0110-230	75 - 100

0111-... SET-MICROMETRE DE PRECIZIE »MAXIMA«

Executie: in cutie de lemn, citire 0,01 mm

RG	Pret brut	Art. Nr.	Dom. masurare/ mm	Numar de micrometre	Cant. de masa de reglare
1		0111-015	0 - 75	3	2
		0111-023	0 - 100	4	3
		0111-031	0 - 150	6	5
Set micrometru de precizie cu certificat de verificare conform ISO 9000					
		0111-201	0 - 100	4	3

Micrometrele continute apartin tipurilor 0111-.../0110-...

0191-...MICROMETRU DE CONTROL CU PASUL FILETULUI de 1mm

Executie: cu suprafete din carburi , cu clema de fixare si clichet de sesizare, pasul filetelui 1 mm, fus-Ø 8 mm, tambur de masurare 28,5 mm Ø, cu diviziune de 100, toate partile componente de citire si etrierul sunt cromate, cu protectie izolatoare ptr. mana; in caseta de lemn

RG	Pret brut	Art.Nr.	Dom. masurare / mm	Pret brut	Art.Nr.	Dom. masurare/ mm
1		0191-035	50 - 75		0191-043	75 - 100

0288-... Microsuport UNIVERSAL

RG	Pret brut	Art.Nr.	Denumire
2		0288-012	Microsuport Universal

0202-...SET INSTRUMENTE DE MASURA DE PRECIZIE »MAXIMA-KIT«, 4-COMPONENTE

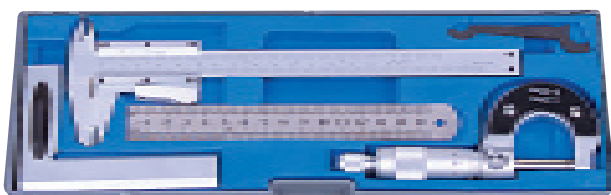

RG	Pret brut	Art. Nr.	Denumire
2		0202-029	<p>»Maxima-Kit« in cutie de plastic, format din:</p> <p>Subler de buzunar „Maxima“ : dom. de masurare 150 mm, inoxidabil, cromat, cu varfuri si tija de adancime, cifrele negru inchis</p> <p>Micrometru „Maxima“: 0 - 25 mm cromate, cu suprafete de masurare din carburi si clichet senzorial</p> <p>Raportor fin „Maxima“: 100 x 70 mm, DIN 875</p> <p>Scala (etalon) „Maxima“: lungime 150 mm, inoxidabil;</p>

0115-... MICROMETRE CU CONTOR DIGITAL conform DIN 863/1

Executie: cu suprafete din carburi, clema de fixare si clichet de sesizare, pasul filetelui 0,5 mm, fus Ø 6,35 mm, tambur de masurare Ø 18 mm, tamburul de masurare cromat, in caseta;

Micrometru citire 1/1000 mm:

Citire 0,01 mm pe dispozitivul de numarare + 0,001 mm pe vernier

Avantaje deosebite: valorile partiale si milimetri completi se pot citi dintr-o privire; fara erori la 0,5 mm (pasul fusului). De aceea este ideal ptr angajati experimentati.

RG	Pret brut	Art. Nr.	Dom. masurare/mm	Precizie/mm	
1		0115-100	0 - 25	0,01	
		0115-118	25 - 50	0,01	
		0115-126	50 - 75	0,01	
		0115-134	75 - 100	0,01	
	Micrometru Digital de numarare cu 1/1000 mm citire pe vernier				
			0115-011	0 - 25	0,001
		0115-029	25 - 50	0,001	

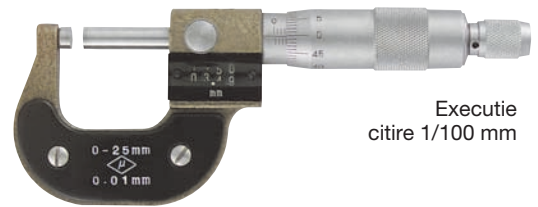

Executie citire 1/100 mm

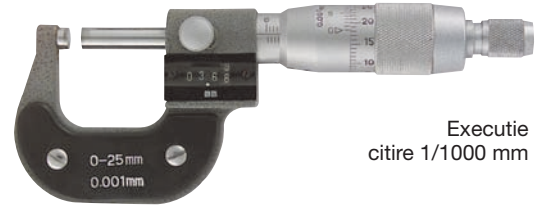

Executie citire 1/1000 mm



0115-... SET MICROMETRE CU CONTOR DIGITAL

in caseta de lemn

RG	Pret brut	Art.Nr.	Dom. masurare in mm	Citire in mm	Cantitatea de micrometre	Cantitatea masei de reglare
1		0115-207	0 - 75	0,01	3	2
		0115-215	0 - 100	0,01	4	3

5581-... MICROMETRU DIGITAL »MAXIMA«

Executie: suprafete din carburi (fus -Ø 6,35 mm), etrier de fixare, clichet fin cu sesizare si etrier termoprotector; Afisaj electronic LCD cu iesire date; comutare mm/toli, punctul zero se poate regla arbitrar, In caseta de lemn

Utilizare: ptr. masurari absolute, relative si de toleranta

Avantaje deosebite: masurari de diferenta

Masurari rapide fara erori

Precizie maxima

RG	Pret brut	Art. Nr.	Dom. masurare/mm	Citire/mm	Precizie/mm
141		5581-010	0 - 25	0,001	+/- 0,002
		5581-028	25 - 50	0,001	+/- 0,002
	protejat impotriva apei , I P 5 4 , cu afisaj 2 LCD				
		5581-109	0 - 25	0,001	+/- 0,002



cu clichet senzorial

! Protejat impotriva apei, ideal ptr. masurarea in ceata de ulei



cu cilindru de frictiune

! 2 afisaje LCD, fata, spate (obisnuit), Si ambele rotabile cu 180° = lizibilitate optima peste tot si in locuri inaccesibile

5510-... INTERFATA PENTRU TOATE INSTRUMENTELE DE MASURA DIGITALE »MAXIMA-DIGIMAX«

pentru transmiterea datelor la PC

Interfata Maxima prin cablul de legatura De la dispozitivul de masurare la PC: Art. Nr. 5510-104, pret brut. RG 141

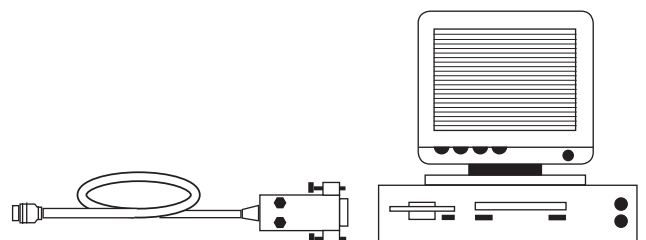
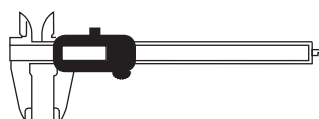

Suprafete de
masurare din carburi
cu 4 nicovale de masurare

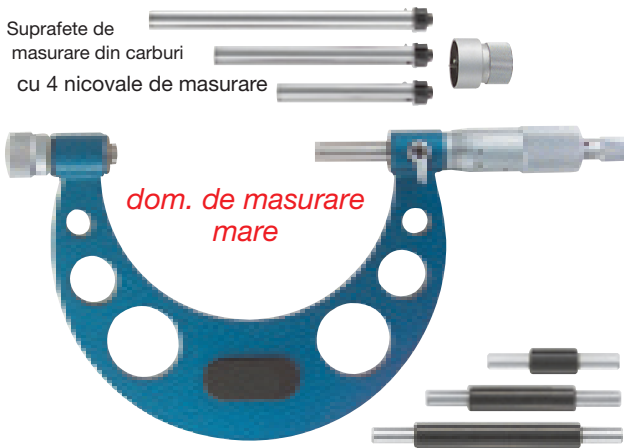

0285-... MICROMETRU DE PRECIZIE CU TIJE INTERSCHIMBABILE

In varianta constructiva usoara cate 100 mm, cu suprafete de masurare din carburi, cleme de fixare si clichet de sesizare;

RG	Pret brut	Art. Nr.	Dom. masurare / mm	Pret brut	Art. Nr.	Dom. masurare/ mm
2		0285-013	0 - 100		0285-064	500 - 600
		0285-021	100 - 200		0285-072	600 - 700
		0285-030	200 - 300		0285-081	700 - 800
		0285-048	300 - 400		0285-099	800 - 900
		0285-056	400 - 500		0285-102	900 - 1000

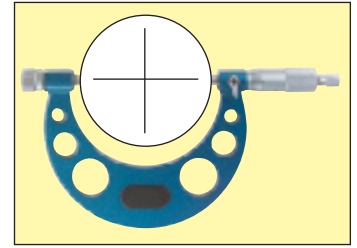
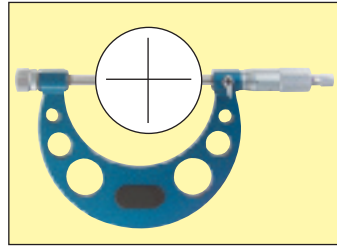
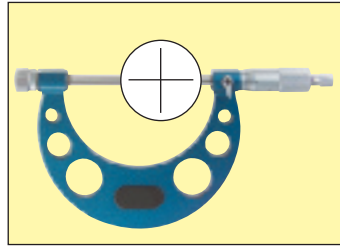
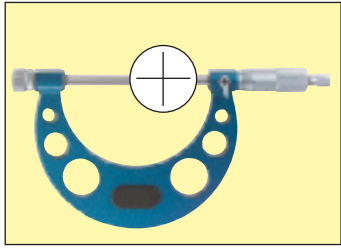

citire 0,002 mm

Suprafete de masurare

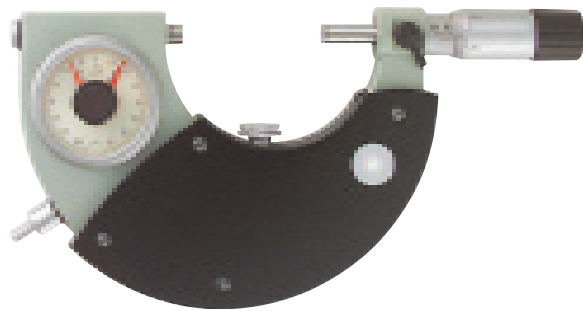

Levier de
tastare

0190-... MICROMETRU DE PRECIZIE CU LEVIER PALPATOR

Cu comparator incorporat, citire 0,002 mm, si suprafete de masurare din carburi, clema de fixare si nicovala de masurare retractabila, tambur de masurare cromat, citire 0,01 mm, Comparator incorporat cu 2 marcaje reglabile ptr. toleranta, citire 0,002 mm; in caseta de lemn.

Utilizare:

I ptr. citirea rapida a valorilor de 0,002 mm

I ca lera circulara reglabila

I ptr. masuratori in productia de serie - trece - nu trece (bun - rebut)

RG	Pret brut	Art. Nr.	Dom. masurare / mm	Pret brut	Art. Nr.	Dom. masurare / mm
2		0190-012	0 - 25		0190-039	50 - 75
			25 - 50		0190-047	75 - 100

Ideal ptr. verificarea
preciziei concentricitatii

Nou



5575-... SISTEM DE TIJE DE CENTRARE

Executie: Brat de centrare cu canal de 8 mm ptr. utilizarea in mandrina de gaurit, ptr. montarea pe canalul comparatorului de 8 mm sau pe suportul in forma de coada de lebada ptr. palpator mic.

Utilizare: pentru centrare si pentru masurarea preciziei concentricitatii

RG	Pret brut	Art. Nr.	Tip	Raza de actiune in mm
2		5575-028	NF 1005	pana la 100



Palpator cu brat de palpate cu comutare automata, basculant pe ambele parti, lungimea bratului de tastare 20 mm, varfuri de tastare cromate dur; citirea 0,01 mm; cu 3 suporturi in forma de coada de lebada si 2 canale de prindere Ø 4 si 8 mm

RG	Pret brut	Art. Nr.	Dom. masurare in mm	Citire in mm	Carcasa-Ø in mm
2		5575-010	± 0,4	0,01	32

5517-.... MICROMETRU DE INTERIOR cu clichet

Canal de fixare neted, fus din metal dur - Ø 6,80 mm, tambur de masurare 20,5 mm Ø cu diviziuni de cate 50-pasul 0,5mm, citire 0,01 mm, toate partile componente de citire cromate, filetul fusului calit si finisat, clichetul este montat in tambur



RG	Pret brut	Art. Nr.	Dom. masurare in mm	Cresterea fusului in mm	Cooda de strangere Ø x lung. de strangere / mm
2		5517-010	0 - 25	0,5	12 x 16

0141-... »MAXIMA« MICROMETRU DE INTERIOR CU VARF citire 0,01 mm

Executie: complet cromat, mat, tambur de masurare usor de citit, cu suprafete de masurare din metal dur, clichet de sesizare fina si surub de fixare; in caseta de lemn valoros

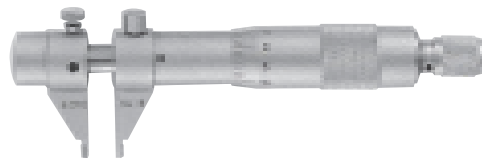

RG	Pret brut	Art. Nr.	Dom. masurare/ mm	Pret brut	Art. Nr.	Dom. masurare/ mm
1		0141-011	5 - 30		0141-038	50 - 75
		0141-020	25 - 50		0141-046	75 - 100

0141-... SETURI DE MICROMETRE DE INTERIOR CU VARF »MAXIMA« – citire – 0,01 mm

Executie: cu inel de reglare / control in caseta, in rest idem cel de sus

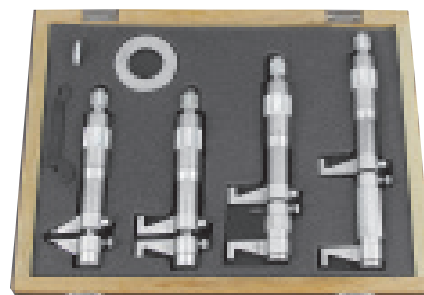

RG	Pret brut	Art. Nr.	Dom. masurare/ mm	Pret brut	Art. Nr.	Dom. masurare/ mm
1		0141-101	5 - 75 (3 Microm.)		0141-119	5 - 100 (4 Microm.)

0121-... MICROMETRU DE INTERIOR (CILINDRIC)

Precizia DIN 863/1 cu cupe de masurare din carburi, citire 0,01 mm, cu pasul fusului 0,5 mm, tambur de masurare 18 mm Ø cu diviziune de 50, toate partile componente de citire cromate, cu protectie de izolare ptr. maini.



RG	Pret brut	Art. Nr.	Dom. masurare/ mm	Pret brut	Art. Nr.	Dom. masurare/ mm
1		0121-118	25 - 50, m. cu maner		0121-029	75 - 100

0122-... »MAXIMA« Set -MICROMETRE DE INTERIOR

Precizia DIN 863/1; cu cupe de masurare din carburi, citire 0,01 mm, pasul fusului 0,5 mm, tambur de masurare 18 mm Ø cu diviziune de 50, toate partile componente de citire cromate, cu protectie de izolare ptr. maini.

RG	Pret brut	Art. Nr.	Dom. masurare/ mm	Pret brut	Art. Nr.	Dom. masurare/ mm
1		0122-106	50 - 250		0122-114	50 - 600





Fara ceas
comparator

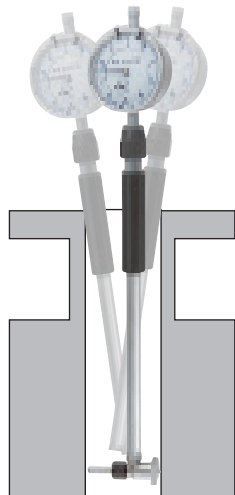

Va rugam comandati in plus:
Ceas comparator 1/100 mm, Art.Nr. 0137-014 sau
Ceas comparator 1/1000 mm, Art.Nr. 0137-031 sau
Ceas comparator digital 1/1000 mm, Art.Nr. 5548-012



»MAXIMA-DIGIMAX«

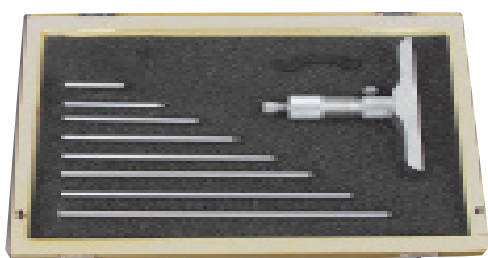
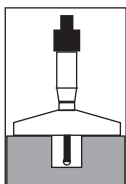
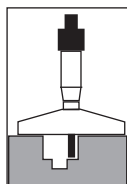

0123-... INSTRUMENTE DE MASURA INTERIOARE CILINDRICE

Cu accesorii de palpate stratificate cu carburi, fara comparator

Utilizare: ptr masurarea fiecarei ovalitati si conicitati, ptr. gauri in-gropate si gauri de trecere

Avantaje specifice: precizie maxima, sensibilitate foarte mare (extra) transmitere practica impecabila, antifrictiune

RG	Pret brut sau ceas de masura	Art.Nr.	Dom. masurare/mm	Adancime masurare/mm
1		0123-021	10 - 18	100
		0123-030	18 - 35	110
		0123-048	35 - 60	140
		0123-013	50 - 150 = model uzual	180
		0123-056	100 - 160	220
		0123-064	160 - 250	400
		0123-072	250 - 450	500
	0123-081	Set instrumente de masura interioare cilindrice 18 - 150 mm		

Art. Nr.
0123-081

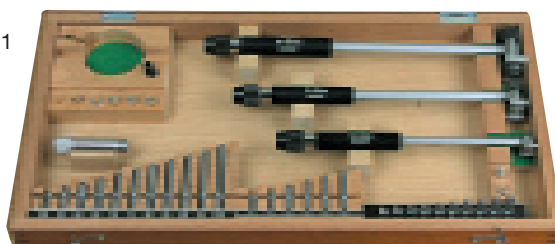

Art. Nr.
0123-013

0136-... MICROMETRU DE PRECIZIE PENTRU ADANCIME

Precizie conform DIN 863/1 cu clichet de avertizare, parti componente de citire cromate, varfurile de masurare calite si finisate, Ø 4,5 mm, pasul fusului 0,5 mm, diviziune de 50, citire 0,01 mm, in caseta de lemn.

RG	Pret Brut	Art.Nr.	Dom. masurare/mm	Latimea puntii/mm
1		0136-018	0 - 25	100

0136-...SET MICROMETRE DE PRECIZIE PENTRU ADANCIME

Micrometru cu varfuri interschimbabile, cu clichet de avertizare, parti componente de citire cromate, varfurile de masurare calite si finisate, Ø 4,5 mm, pasul fusului 0,5 mm, diviziune de 50, citire 0,01 mm, in caseta de lemn.

RG	Pret brut	Art.Nr.	Dom. masurare/mm	Latimea puntii/mm	Numarul de stifturi
1		0136-042	0 - 100	100	4
		0136-034	0 - 150	60	6
		0136-051	0 - 200	100	8

Pret avantajos!



I intodeauna masuri exacte, **rapide** si **fara erori**
 I valoarea efectiva se poate citi imediat (instantaneu)

5582-...MICROMETRU INTERIOR CU 3 PUNCTE »MAXIMA«

Executie: Suprafetele de masurare calite si finisate, piesele de citire cromate, cu clichet senzorial; citire 0,005mm, adancime de masurare 70 mm cu extensie (11 - 20 mm) resp. 220 mm (20 - 40 mm);

RG	Pret brut	Art. Nr.	Dom. masurare (citire) in mm	Pret brut	Art. Nr.	Dom. masurare (citire) in mm
2		5582-075	17-20 (0.005)		5582-091	25-30 (0.005)
		5582-083	20 - 25 (0,005)		5582-105	30 - 35 (0,005)
		5582-091	25 - 30 (0,005)		5582-113	35 - 40 (0,005)

5582-... MICROMETRU DE INTERIOR IN 3 PUNCTE »MAXIMA«

Executie: precizia conform DIN 863/1, cu inel de reglare;
Suprafetele de masurare calite si finisate, partile componente de citire cromate, corpul micrometrului lacuit; cu clichet de sesizare; citire: 0,005 mm

Avantaje specifice:

- masurare exacta si rapida; ● date de masurare garantate intotdeauna, corect garantate si la personal nescolarizat
- valoarea efectiva a gaurii se poate citi imediat
- prin tastatorul in forma de carlig (gheara) se pot efectua masuratori a gaurilor ingropate pana la baza foarte usor.

RG	Pret brut	Art. Nr.	Dom. masurare/mm	Pret brut	Art. Nr.	Dom. masurare/mm
		5582-202	12 - 16		5582-261	40 - 50
		5582-229	16 - 20		5582-270	50 - 63
		5582-237	20 - 25		5582-288	62 - 75
		5582-245	25 - 30		5582-296	75 - 88
		5582-253	30 - 40		5582-300	87 - 100
2		»Maxima« Set-micrometru de interior-in trei puncte				
		5582-121	Set, 12 - 20 mm: 2 micrometre (12 - 16, 16 - 20 mm), 1 inel de reglare (16 mm) precum si prelungirea 150 mm			
		5582-130	Set, 20 - 50 mm: 4 micrometre (20 - 25, 25 - 30, 30 - 40, 40 - 50 mm), 2 inele de reglare (25 si 40 mm) precum si prelungirea 150 mm			
		5582-148	Set, 50 - 100 mm: 4 micrometre (50 - 63, 62 - 75, 75 - 88, 87 - 100 mm), 2 inele de reglare (62 si 87 mm) prelungire pana la 150 mm			



5582-... SETURI DE MICROMETRE DIGITALE DE INTERIOR IN 3 PUNCTE, IP 54, protejate de apa, in geanta

Executie: Suprafete de masurare din carburi, pasul fusului 0,5 mm, citire 0,001 mm

(Precizia micrometrelor:

Pana la 40 mm Ø = ± 0,004 mm;

Pana la 200 mm Ø = ± 0,005 mm;

Pana la 250 mm Ø = ± 0,007 mm);



complet cu inele de reglare



Foto prezinta Art. Nr. 5514-321

Avantaje deosebite:

I IP 54, protejate impotriva apei, ideal ptr. ceata de ulei;

pentru masurarea gaurilor ingropate sistem de masurare cu iesire date RS 232

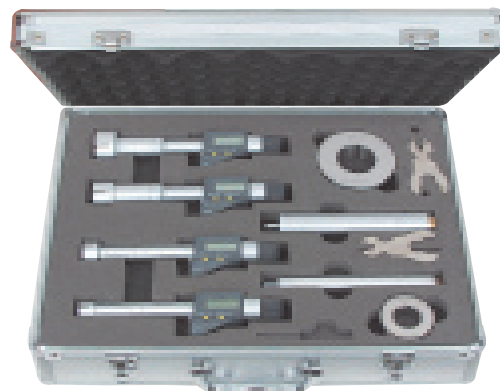
(cablu de legatura si software la cerere)

RG	Pret brut	Art. Nr.	Set, dom. masurare
		5514-304	Set, 6 - 12 mm: 3 micrometre (6 - 8, 8 - 10, 10 - 12 mm), 3 inele de reglare (6, 8, 10 mm) precum si 1 prelungire, 100 mm
		5514-312	Set, 12 - 20 mm: 2 micrometre (12 - 16, 16 - 20 mm), 1 inel de reglare (16 mm) precum si 1 prelungire, 150 mm
141		5514-321	Set, 20 - 50 mm: 4 micrometre (20 - 25, 25 - 30, 30 - 40, 40 - 50 mm), 2 inele de reglare (25, 40 mm) precum si 2 prelungiri, 150 mm
		5514-339	Set, 50 - 100 mm: 4 micrometre (50 - 63, 62 - 75, 75 - 88, 87 - 100 mm), 2 inele de reglare (62 u. 87 mm) precum si 1 prelungire, 150 mm
		5514-347	Set, 100 - 250 mm: 2 micrometre (100 - 150, 150 - 250 mm), 1 inel de reglare (150 mm) precum si 1 prelungire, 150 mm
			Cablu de legatura pentru conectarea la computer Software pentru transmiterea de date catre Microsoft Excel®



Foto prezinta Art. Nr. 5514-339



0119-... APARAT DE MASURARE RAPIDA A GROSIMII

Cu dispozitiv de ridicare, citire 0,01 mm, presiune (presare) de masurare constanta, sticla indestructibila, rama profil din Al robust

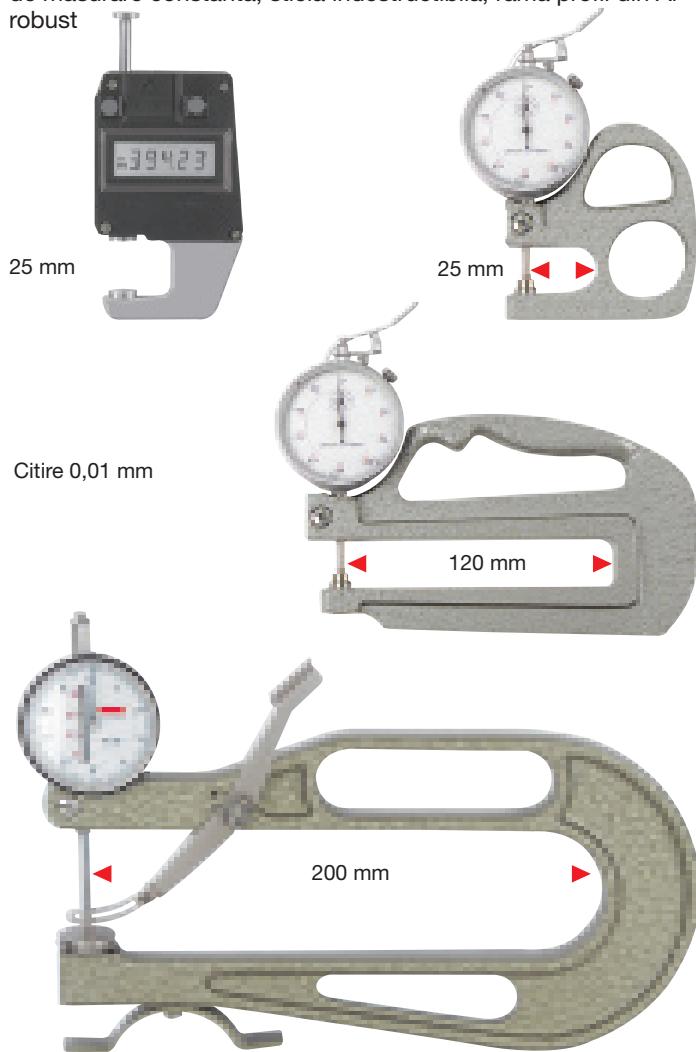

25 mm

25 mm

Citire 0,01 mm

120 mm

200 mm

RG	Pret brut	Art.Nr.	Citire in mm	Mod masurare in mm	Descarcare in mm
1		0119-016	1/100	10	25
		0119-024	1/100	10	120
		0119-032	1/10	30	200
Cu afisaj electronic LCD					
141		0119-211	1/100	25	25

0119-...APARAT DE MASURARE A GROSIMII FOLIILOR

cu dispozitiv de ridicare;
citire 0,001 mm;
presiune constanta de masurare,
sticla indestructibila, rame
profil Al robust;
maner izolat;
6,35 mm Ø

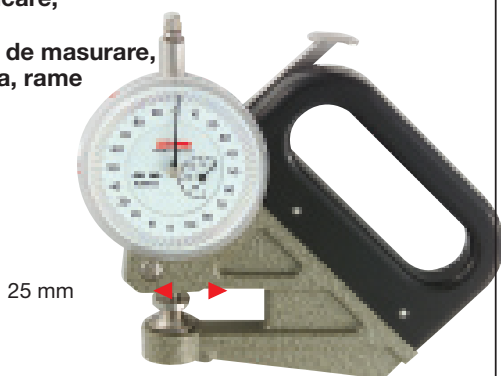

25 mm

RG	Pret brut	Art.Nr.	Citire in mm	Mod masurare in mm	Descarcare in mm
1		0119-041	1/1000	1	30

0216-... COMPAS SFERIC CU ARC

cu contacte de masurare, 2x2 mm,
articulatie si scala din alama

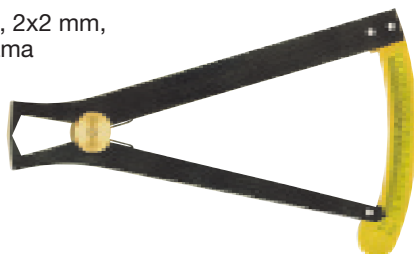

RG	Pret brut	Art. Nr.	Dom. masurare in mm	Citire in mm	Descarcare in mm
2		0216-101	0 - 15	0,1	23

0105-... »MAXIMA« Palpator interior

cu contacte de masurare
in forma rotunda, 2 mm Ø



Executie digitala,
livrabila la cerere!

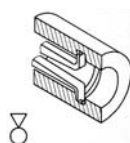

Pret avantajos

RG	Pret brut	Art. Nr.	Dom. masurare in mm	Citire in mm	Dimensiuni/mm		
					L	A	B
2		0105-015	5 - 15	0,01	30	1,0	1,5
		0105-023	10 - 20	0,01	30	1,5	3,0
		0105-031	20 - 30	0,01	30	2,0	6,5

0105-... »MAXIMA« Palpator exterior

cu contacte sferice de masurare Ø 2 mm



Executie digitala
Se poate livra la cerere!

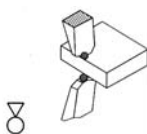

pret avantajos!

RG	Pret brut	Art. Nr.	Dom. masurare in mm	Citire in mm	Dimensiuni/mm		
					L	A	B
2		0105-058	0 - 10	0,01	40	3,0	8,0
		0105-066	10 - 20	0,01	40	3,0	8,0
		0105-074	20 - 30	0,01	40	3,0	8,0

Palpator rapid de exterior si interior

Made in Germany,
livrabila la cerere



Va rugam solicitati
catalogul electronic

0171-... PALPATOR FIN DE CONTROL

Citire 0,001 mm; precizia conf. DIN 879, protejat impotriva impactului, cursa libera 3 mm, domeniu de masurare 0,1 mm, cu doua marcaje reglabile ptr. tolerante, canal de fixare 8 mm/h6, calit, din otel inoxidabil; cu declansator flexibil si carcasa de protectie impotriva dereglajului neintentionat al reglajului fin al aratatorului.

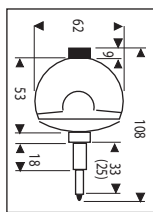

Cu declansator flexibil si carcasa de protectie impotriva dereglajului neintentionat al reglajului fin al aratatorului.

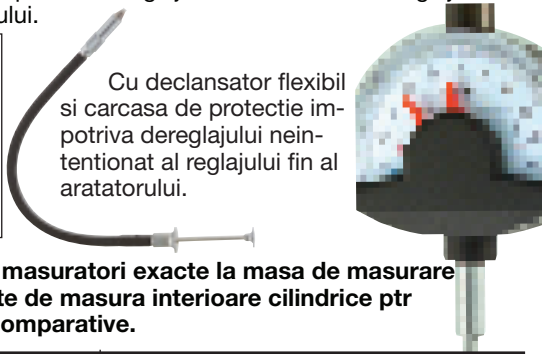

Utilizare: ptr masuratori exacte la masa de masurare sau in aparate de masura interioare cilindrice ptr masuratori comparative.

RG	Pret brut	Art. Nr.	Dom. masurare/ mm	Executie
2		0171-018	0,1	cu declansator flexibil

0170-...CEAS COMPARATOR CU PALPATOR »AUTOMATIC«

Citire 0,01 mm; carcasa cromata, inel exterior -Ø 40 mm, Cu ax de 8mm / h6 si suport in forma de coada de randunica



Avantaje deosebite:

- comutare automata a dispozitivului de palpate (masuratori in 2 directii opuse cu 180°, posibil fara comutarea directiei de masurare)
- suport in forma de coada de randunica

RG	Pret brut	Art. Nr.	Model	Dom. masurare in mm	Executie
1		0170-011	A	0,8	cu brat de masurare-bila

5575-... PALPATOR AUTOMATIC »MAXIMA«

Citire 0,01 mm; carcasa stabila cromata, brat de palpate cu posibilitate de comutare automata, rabatabil pe ambele parti, lungimea bratului de palpate 20 mm, varful de palpate cromat dur; cadranul reglabil pe pozitia 0

3 suporturi in forma de coada de randunica si 2 axe 4 si 8 mm Ø



Utilizare: ca aparat de masurare comparator, verificarea devierilor de la cota necesara; de ex ptr verificari circulare, ptr. masurari interioare, ptr. verificarea paralelitatii si ptr. indreptarea pieselor

RG	Pret brut	Art. Nr.	Dom. masurare in mm	Citire in mm	Carcasa-Ø in mm
2		5575-010	± 0,4	0,01	32

5515-...CEAS COMPARATOR - DIGITAL »MAXIMA-DIGIMAX«

Citire 0,01 mm; ax 8 mm, cu declansator flexibil si 3 accesorii de masurare (normal, plat, sfera), in caseta



I foarte avantajos ca pret

Fara erori

Precizie maxima

Afisaj electronic

LCD

Cifre mari, se pot citi bine

lesire date ptr interfata

(Art. Nr. 5510-104)

Punctul zero se poate stabili arbitrar

Comutare in mm/toli

Tasta de retinere a valorii masurate

Masurare normala, masurare diferite, masurare

minim / maxim



RG	Pret brut	Art. Nr.	Dom. masurare in mm	Precizie/mm (precizie de repetat./mm)	Dim. in mm
141		5515-122	0 - 10	+/- 0,02 (0,01)	ca. 60 Ø

5515-... COMPARATOR-DIGITAL »MAXIMA-DIGIMAX«

Citire 0,01 mm; ax de 8 mm, in caseta



- Afisaj electronic LCD
- Se poate citi bine, cifre mari
- lesire date ptr. interfata (Art. Nr. 5510-104)
- punctul zero se poate stabili arbitrar
- comutare mm/toli
- precizie maxima - fara erori

RG	Pret brut	Art. Nr.	Dom. masurare in mm	Precizie/mm (precizie de repetare./mm)	Dim. Ø in mm
141		5515-114	0 - 25	+/- 0,02 (0,01)	ca. 60 x 155

5548...COMPARATOR DIGITAL DE PRECIZIE

Citire 0,001 mm, ax de Ø 8 mm , Cu filet M 2,5 ptr toate varfurile de masurare

I afisaj electronic LCD

(Marimea cifrelor 6 mm)

I Forta de masurare: 0,75 - 1,80 N

I Unitate de afisare reglabila 270°

= adaptarea la diverse conditii de lucru

I punctul zero se poate stabili arbitrar

I comutare mm/toli

I tasta de retinere a valorii masurate

I masurarea valorilor limita. La depasirea in sus sau

in jos a unei valori limita reglabila inferioare /

superioare scala va lumina intermitent.

Complet cu acumulator (se va incarca inainte de

punerea in functiune conform instructiunii de

deservire), precum si adaptor de retea 230V, ideal pentru

folosire indelungata, se pastreaza in caseta.



RG	Pret brut	Art. Nr.	Dom. masurare in mm	Precizie/mm (precizie de repetare./mm)	Dim. in mm
141		5548-012	0 - 25	+/- 0,002 (0,001)	71 Ø / 140 H

0129-... COMPARATOR MIC DE PRECIZIE

Precizia conform DIN 878-E, protejat impotriva impactului, citire 0,01 mm, inel exterior -Ø 40 mm, canal de fixare 8mm/h6, calit, filet interior M 2,5 / 6g, doua marcaje reglabile ptr. toleranta; Bolt de masurare si ax din otel inoxidabil in caseta din plastic

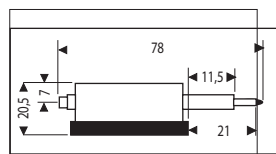

Citire 0,01 mm,
domeniu de masurare 0 - 5 mm,
doar 40 mm Ø inel exterior ;
Art. 0129-011, Pret brut RG 1

-Ideal in constructia de masini si instalatii.

0137-... COMPARATOR FIN DE PRECIZIE

Precizia dupa DIN 878, citire 0,001 mm, inel exterior -Ø 58 mm, ax 8 mm/h6, calit, cu filet interior M 2,5 / 6g, Cu doua marcaje reglabile de toleranta; Bolt de masurare si ax din otel inoxidabil, in caseta din plastic



Cu certificat de verificare:
Citire 0,001 mm,
Domeniu de masurare 0 - 1 mm,
• rotatia aratatorului = 0,2 mm;
Art. 0137-031,
pret brut RG 1

5592-... COMPARATOR PT. VERIFICAREA CEAPRAZULUI DINTILOR

Comparatorul cu cele 4 puncte de asezare se aseaza in asa fel pe panza, incat accesoriul de masurat sa atinga varful de taiere, Citirea este posibila din ambele parti; Cu marcaj reglabil pentru tolerante.



Citire 0,1 mm,
Domeniu de masurare
0 - 2 mm,
Art. 5592-011,
Pret brut RG 2

0137-... DECLANSATOR FLEXIBIL

Ptr. toate comparatoarele cu
domeniul de masurare 10 mm

Art. 0137-154
pret brut RG



5519-... COMPARATOARE MARI DE PRECIZIE

Precizia conform DIN 878-A, citire 0,01 mm, inel exterior -Ø 80 mm, ax calit (8 resp. 10 mm) h6, calit, filet interior calit M 2,5 / 6g, bolt de masurare si ax din otel inoxidabil, in caseta de plastic



Citire 0,01 mm,
dom. de masurare 0 - 10 mm,
Ø coada 8 mm ;
Art. 5519-012,
pret brut RG 1



Citire 0,01 mm,
dom. de masurare
0 - 100 mm,
Ø coada 10 mm ;
Art. 5519-021,
pret brut
RG 1

5561-... ACCESORII LIVRABILE PTR. PALPATOARE

pentru comparatoare cu filet interior M 2,5 / 6g

Model 1: Art. Nr. 5561-019 pret brut RG 2		Model 2: Art. Nr. 5561-027 pret brut RG 2	
Model 3: Art. Nr. 5561-035 pret brut RG 2		Model 4: Art. Nr. 5561-043 pret brut RG 2	
Model 5: Art. Nr. 5561-051 pret brut RG 2		Model 6: Art. Nr. 5561-060 pret brut RG 2	
Model 7: Art. Nr. 5561-078 pret brut RG 2		Model 8: Art. Nr. 5561-086 pret brut RG 2	
Model 9: Art. Nr. 5561-094 pret brut RG 2		Model 10: Art. Nr. 5561-108 pret brut RG 2	
Mod. 11: Art. Nr. 5561-116 pret brut RG 2		Model 12: Art. Nr. 5561-124 pret brut RG 2	
Model 13: Art. Nr. 5561-132 pret brut RG 2		Model 14: Art. Nr. 5561-141 pret brut RG 2	
Model 15: Art. Nr. 5561-159 pret brut RG 2		Model 16: Art. Nr. 5561-167 pret brut RG 2	

5561-... PRELUNGITOARE

Ptr. toate comparatoarele cu filet interior M 2,5

RG	Pret brut	Art. Nr.	Lungime in mm
2		5561-205	10
		5561-213	15
		5561-221	20
		5561-230	30
		5561-248	40

Model uzual!

Model A:



dom. de masurare
0 - 10 mm;
Art. 0137-014,
pret brut RG 1

Model A/Etalon



cu **certificat de verificare:**
dom. de masurare
0 - 10 mm;
Art. 0137-201,
pret brut RG 1

Model A/Fix



cu **surub de fixare:**
dom. de masurare
0 - 10 mm;
Art. 0137-081,
pret brut RG 1

Model B

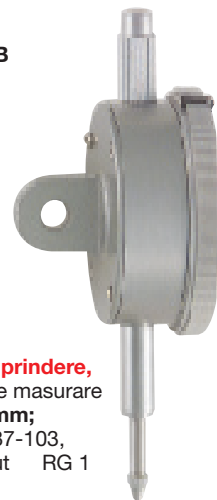

cu **inel de prindere,**
dom. de masurare
0 - 10 mm;
Art. 0137-103,
pret brut RG 1

Model D



cu **supapa de aerisire:**
dom. de masurare
0 - 10 mm;
Art. 0137-111,
pret brut RG 1

Model E



cu **declansator flexibil:**
dom. de masurare
0 - 10 mm;
Art. 0137-120,
pret brut RG 1

Model F



cu **partea din spate magnetica:**
dom. de masurare
0 - 10 mm;
Art. 0137-138,
pret brut RG 1

Model K



etans:
dom. de masurare
0 - 10 mm;
Art. 0137-146,
pret brut RG 1

Toate comparatoarele de precizie pe aceasta parte:
Protejate impotriva impactului, inel exterior -Ø 58 mm,
Ax 8 mm / h6 – calit, filet interior M2,5 / 6g, cu doua marcaje de toleranta;
Axul si varful palpator din otel inoxidabil, se livreaza in cutie de plastic

Model J



protejat impotriva stropilor de apa:
dom. de masurare
0 - 10 mm;
Art. 0137-073,
pret brut RG 1

Model G



Dom. de masurare
0 - 20 mm;
Art. 0137-022,
pret brut RG 1

Model H:



Dom. de masurare
0 - 30 mm;
Art. 0137-057,
pret brut RG 1

Model J



Dom. de masurare
0 - 50 mm;
Art. 0137-065,
pret brut RG 1

0131-... STATIV DE MASURARE MAGNETIC cu sistem de tije stabile

Sistem de tije stabile, cromat, cu suport transversal, reglabil pe toate partile; cu suport ptr comparatoare si canal de Ø 8 mm

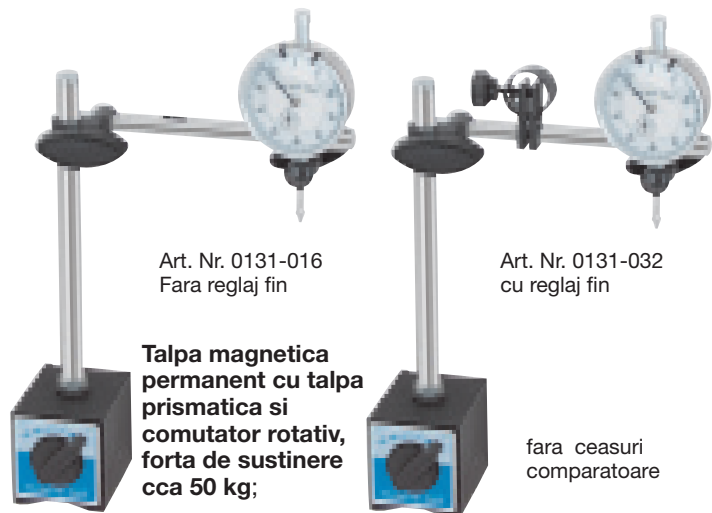

Art. Nr. 0131-016
Fara reglaj fin

Art. Nr. 0131-032
cu reglaj fin

Talpa magnetica permanent cu talpa prismatica si comutator rotativ, forta de sustinere cca 50 kg;

fara ceasuri comparatoare

RG	Pret brut	Art. Nr.	Inaltime totala/mm	Dim. suport Ø in mm	Lungimea bratului mm	Talpa magnetica LxAxH / mm
1		0131-016	240	12	165	60x50x55
		0131-032	240	12	165	60x50x55

0132-... »FLEX-CHECK« STATIV MAGNETIC cu suport flexibil;

suport cu 12 componente, care se pot fixa printr-un cablu de tensionare in orice pozitie arbitrara: ptr. masuratori in orice pozitie

Cu suport ptr. comparatoare cu canal de Ø 8 si 10 mm



Talpa magnetica permanent cu talpa prismatica si comutator rotativ, forta de sustinere cca 50 kg

fara ceas comparator

RG	Pret brut	Art. Nr.	Inaltime totala in mm	Lungime suport flexibil/mm	Talpa magnetica L x A x H/mm
1		0132-012	340	290	60 x 50 x 55

0138-...MASA DE MASURARE FINA PENTRU GREUTATI



Calitatea 1 : Suprafata mesei cu caneluri ptr. praf, slefuita fin si finisata, stalpul si sistemul de tije din inox, cu piulita limitatoare pe inaltime

RG	Pret brut	Art. Nr.	Marimea mesei in mm	Inaltime mas.x L. bratelor despartite/mm	Suporti Ø/mm	Greutate in kg
2		0138-045	120 x 100	200 x 200	25	7

0131-... STATIV DE MASURARE- CU MAGNET GREU - cu inaltime mare de masurare

cu sistem de tije deosebit de puternic si stabil, cromat, cu suport transversal; suportul transversal cu articulatie si reglaj fin; cu suport ptr. comparatoare cu canal de Ø 8 mm

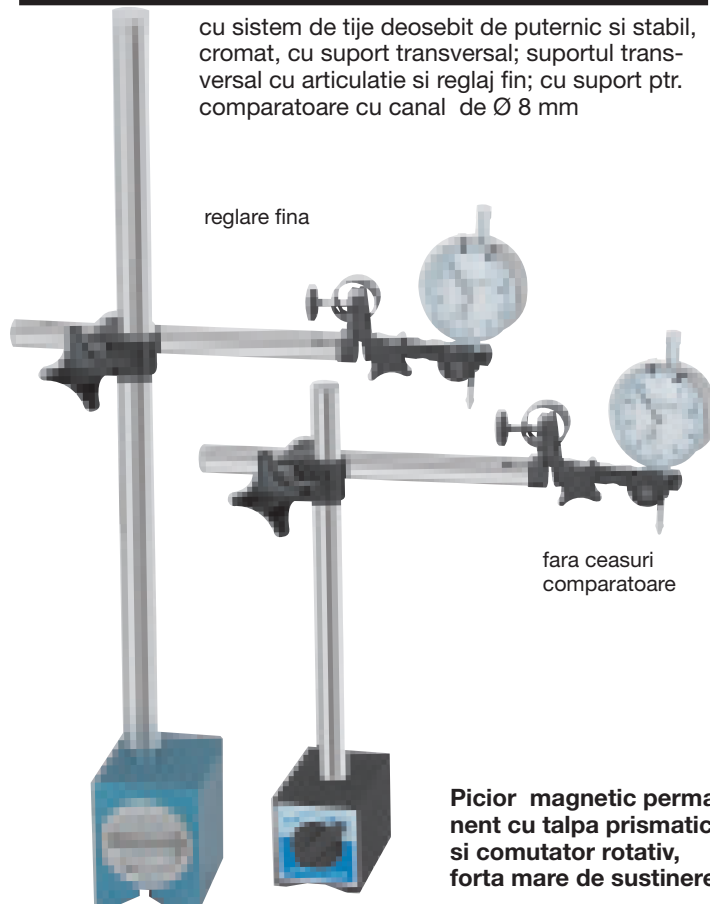

reglare fina

fara ceasuri comparatoare

Picior magnetic permanent cu talpa prismatica si comutator rotativ, forta mare de sustinere

RG	Pret brut	Art. Nr.	Inaltime totala/mm	Dim. suport Ø in mm	Lungimea bratului/mm	talpa magnetica LxAxH/mm
2		0131-067	285	16	180	75x50x55
		0131-075	Sistemele de masurare de la 0131-067, fara talpa magnetica			
		0131-041	500	25	180	75x60x80

0175-... PICIORUSE MAGNETICE

Cu talpa prismatica, comutator rotativ si filet de racordare M8



RG	Pret brut	Art. Nr.	Filet de prindere	Putere de retentie in kg	Talpa magnetica LxAxH/ mm
1		0175-013	M 8	50	60x50x55
		0175-021	M 8	100	75x50x55

5520-... SUPORT MAGNETIC PTR. COMPARATOR

Parte neteda de aderenta cu magneti sinterizati puternic, bratul suport (de preluare) rabatabil.

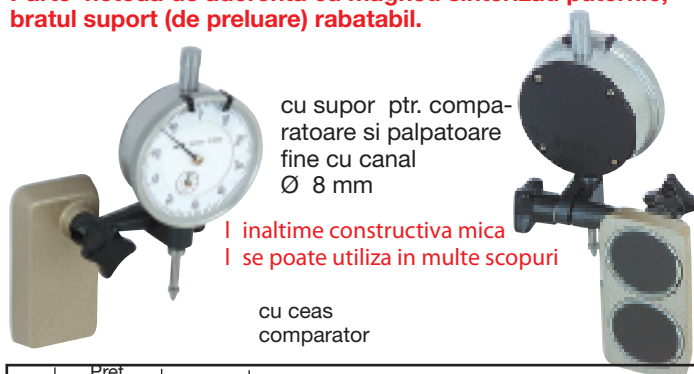

cu suport ptr. comparatoare si palpatoare fine cu canal Ø 8 mm

I inaltime constructiva mica
I se poate utiliza in multe scopuri

cu ceas comparator

RG	Pret brut	Art. Nr.	Lungime x latime x inaltime / mm
2		5520-011	65 x 32 x 6

5572-... »GIGANT EXTRA « STATIV DE MASURARE cu tensionare centrala

Cu articulatie centrala in orice directie, pozitie unghiulara si pozitie rabatabila si rotativa, cu reglaj fin

Nou

Reglabil rapid prin tensionare centrala

Superstabil!

fara ceas comparator

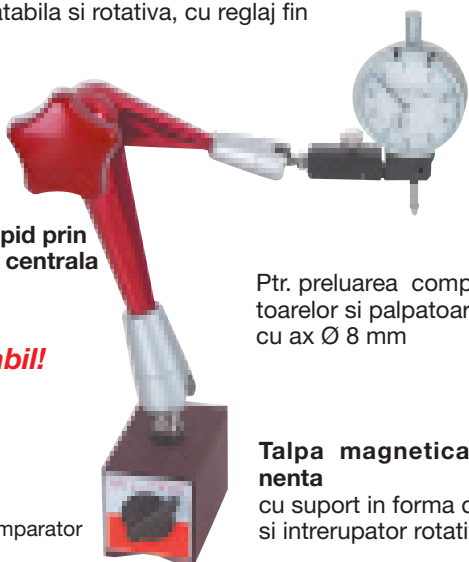

Ptr. preluarea comparatoarelor si palpatoarelor fine cu ax Ø 8 mm

Talpa magnetica-permanenta

cu suport in forma de prisma si interruptor rotativ,

RG	Pret brut	Art. Nr.	Inaltime totala in mm	Raza de actiune in mm	Talpa magnetica LxAxH in mm
2		5572-011	410	ca. 360	75 x 60 x 60

5571-... »MULTIFLEX« STATIV MAGNETIC PENTRU MASURATORI FINE

Articulatii sferice, rotative si rabatabile in orice directii, cu tensionare centrala, cu reglaj fin 8 mm suport pt. comparator si suport in forma de coada de randunica pt. palpator fin.

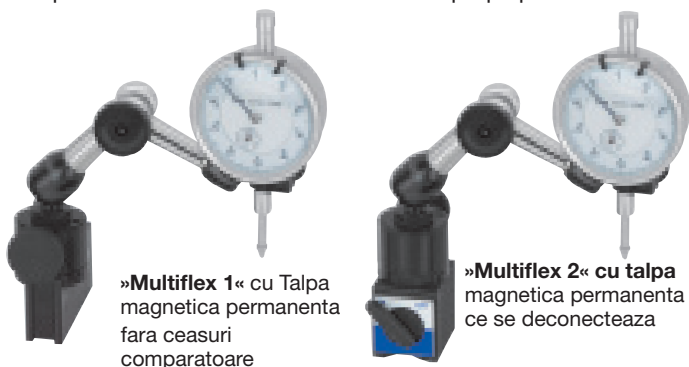

»Multiflex 1« cu Talpa magnetica permanenta fara ceasuri comparatoare

»Multiflex 2« cu talpa magnetica permanenta ce se deconecteaza

RG	Pret brut	Art. Nr.	Tip	Executie
2		5571-014	Multiflex 1	cu talpa magnetica permanenta
		5571-031	Multiflex 2	cu talpa magnetica ce se deconecteaza

5521-... CONECTOR MAGNETIC PTR. COMPARATOR

Cu talpa prismatica si 2 magneti suplimentari de aderenta pe partile longitudinale, bratul de preluare rabatabil in toate directiile

Ptr. preluarea comparatoarelor si palpatoarelor fine cu ax Ø 8 mm

I Bun si ptr. masurarea si reglarea masinilor de frezat si gaurit (ptr. asezarea pe dornul de frezare)



fara ceas comparator

RG	Pret brut	Art. Nr.	Lungime x latime x inaltime / mm
2		5521-017	45 x 35 x 23

5558-.../0175-... »NOGA-FIX« STATIV MAGNETIC DE MASURARE cu tensionare centrala

sistem de tije patentat cu tensionare centrala: prin pretensionare stativul sustine forma reglata si dupa desprinderea surubului de prindere; sistem de tije ptr comparatoare 8 mm Ø, absolut inoxidabil

Suport universal ptr comparatoare



cu reglaj fin

Ptr. canal de Ø 6 si 8 mm, canal Ø 3/8" - precum si coada de randunica



fara ceas comparator

Nou

RG	Pret brut	Art. Nr.	Executie	Raza de actiune
2		5558-115	stative cu talpa magnetica	pana la 290 mm
		5558-123	stative cu talpa magnetica	pana la 600 mm
		5558-018	stative fara talpa magnetica	pana 240 mm
1		0175-030	talpa magnetica de schimb, 120 x 50 x 55 mm, M 10	

5558-... SET: STATIV DE MASURAT + COMPARATOR

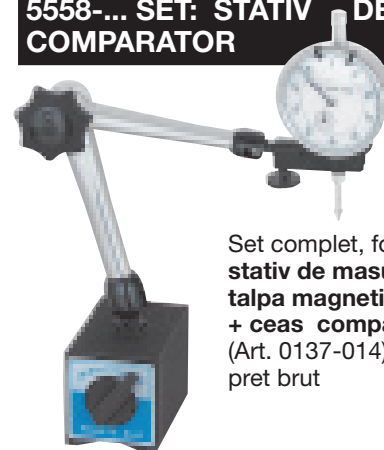

Si mai avantajos in set!

Set complet, formata din:
stativ de masurat cu prindere centrala si **talpa magnetica** (Art. 0174-017) + **ceas comparator**, 1/10 mm (Art. 0137-014) Art. Nr. 5558-107, pret brut RG 2

0174-... »STABIL-SUPER« STATIV MAGNETIC DE MASURARE cu tensionare centrala

Prin doua articulatii sferice si o articulatie centrala in orice directie, pozitie unghiulara si pozitia rabatabila si rotativa, cu reglaj fin.

Reglabil rapid ptr tensionare centrala

Cu suport pt. comparatoare cu ax Ø 8 mm si suport ptr. palpator mic

Talpa magnetica permanenta
Cu talpa prismatica si comutator rotativ, forta de sustinere cca. 100 kg.

fara ceas comparator

RG	Pret brut	Art. Nr.	Inaltime totala in mm	Raza de actiune in mm	Talpa magnetica LxAxH in mm
2		0174-017	310	260	70x50x55

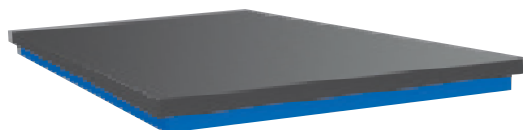
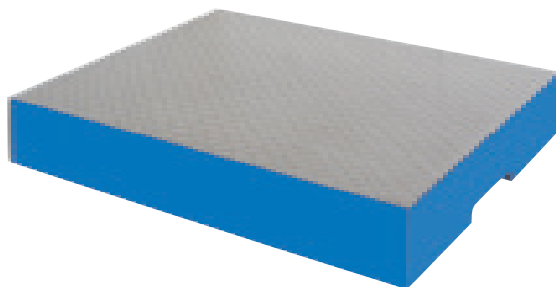

PLACI DE TRASARE conform DIN 876/1

Din aliaj otel special, finisat, turnat dens fara pori,
Prelucrat unghiular pe 4 parti, executie cu nervuri

RG	Pret brut	Art. Nr.	Dimensiuni in mm	Pret brut	Art.Nr.	Dimensiuni in mm
2		0249-122	300 x 250		0249-157	600 x 900
		0249-033	300 x 300		0249-114	900 x 1200
		0249-131	450 x 450		0249-106	1000 x 1000
		0249-149	450 x 600		La cerere	1000 x 2000
		0249-068	500 x 500			

0269-... PLACI DE INDREPTARE, executie robusta

conform DIN, din fonta speciala, suprafata si toate cele 4 fete prelucrate fin

RG	Pret brut	Art. Nr.	Dimensiuni in mm	Suporturi pentru placi		
				Pret brut	Art. Nr.	Greutate cca./kg
117		0269-018	400 x 400		0269-107	16
		0269-026	600x600		0269-115	29

0256-... SUPORTI PRISMATICI

Calitatea 1, din fonta speciala, finisat ,
cu 4 muchii paralele

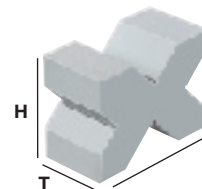
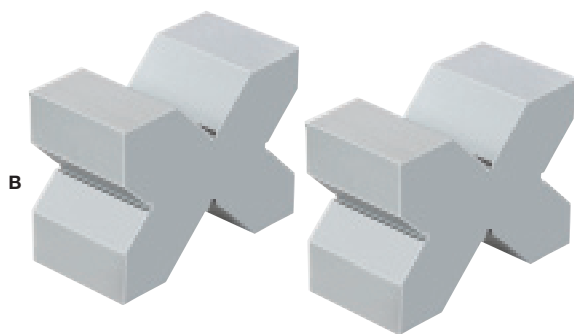

RG	Pret brut	Art.Nr.	Dimensiuni L x A x H/mm	Pret brut	Art.Nr.	Dimensiuni in mm
2		0256-013	120 x 60 x 90		0256-030	200 x 150 x 80
		0256-021	150 x 65 x 100			

5525-... PRISME DUBLE CU BRATARA DE FIXARE

Executie fina din otel , cu etrier de tensionare, slefuite fin in pereche si ajustate, cu cate 2 crestaturi 90°;
Precizie 4 mm

Utilizare: ptr. prelucrarea si controlarea pieselor cilindrice

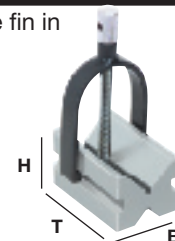
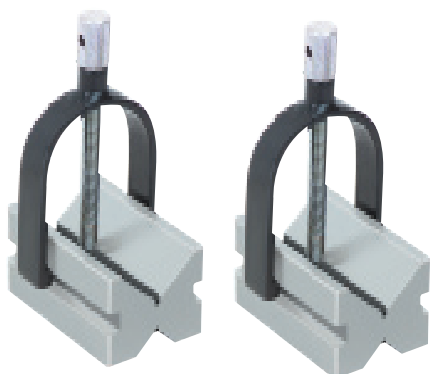

RG	Pret brut	Art. Nr.	Dimensiuni L x A x H/mm	pentru Ø mm
2		5525-012	40 x 45 x 36	5 - 20
		5525-021	45 x 70 x 40	5 - 25

0255-...SUPORTI PRISMATICI

Calitatea 1, finisate, unghi de crestare 90°, ptr. lucrari precise de gaurire si slefuire

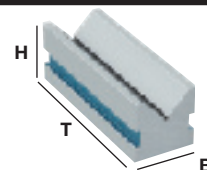
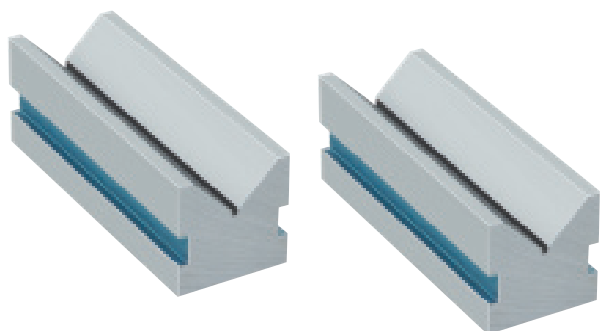

RG	Pret brut	Art. Nr.	Dimensiuni L x A x H/mm	Pret brut	Art. Nr.	Dimensiuni L x A x H/mm
2		0255-017	45 x 100 x 45		0255-033	70 x 200 x 70
		0255-025	55 x 150 x 55		0255-041	105 x 300 x 105

6248-... BLOCURI PRISMATICE UNGHIULARE REGLABILE

Din otel special, calit, slefuit cu precizie; unghiul se regleaza printr-o scala auxiliara de pe partea frontala a prisme
Utilizare: in menghine de masini, pe placi de trasare, in constructia de dispozitive etc, pe masini de gaurit, frezat si slefuit.

RG	Pret brut	Art. Nr.	Dimensiuni L x A x H(h) / mm	Precizie in mm	Zona de reglare in grade
28		6248-012	75 x 25 x 35 (22)	0,005	0-30/0-60
		6248-021	102 x 46 x 47 (28)	0,005	0-30/0-60



Fixabil de jos

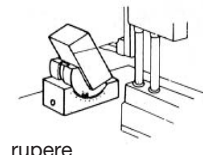
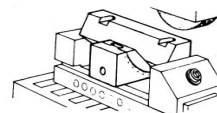
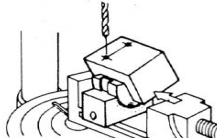
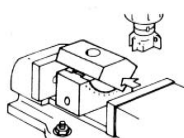
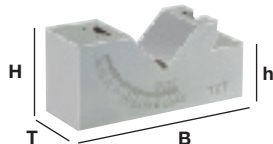

rupere

0295-... PRISME MAGNETICE PERMANENTE

Executie : indreptate individual sau in perechi;
3 suprafete magnetice de contact,
se pot conecta si deconecta impreuna (prisma mica si mare, suprafata frontala, partea superioara si inferioara); suprafata frontala si laterala slefuite exact la unghi fata de ambele prisme
Utilizare: ptr. lucrari de masurare, control si slefuire

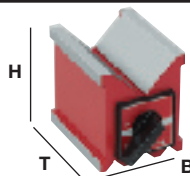

Pentru piese rotunde!

Vedere parte de sus

Vedere parte de jos



RG	Pret brut	Art. Nr.	Executie	Dimensiuni L x A x H/mm	pt. arbore Ø/mm	Paralelitate si precizia unghiurilor
2	pe buc.	0295-108	individual	70 x 85 x 85	5 - 65	5 μ pe 100 mm
	pe pereche	0295-116	pe perechi	70 x 85 x 85	5 - 65	5 μ pe 100 mm

0291-... NIVELA DE PRECIZIE PTR. MASINI

Conform DIN 877, carcasa robusta din fonta speciala, cu talpa prismatica, lacuit. Suprafetele de asezare finisate, cu nivel cu bula de aer, transversala, protectie izolatoare ptr. maini; in cutie de lemn
1 liniuta = abatere de la orizontala in milimetri per metri.

protectie prin izolatie.pt.maini

RG	Sensibilitate	Pret brut	Art.Nr.	Lungime in mm	Pret brut	Art.Nr.	Lungime in mm
2	0,10 mm/m		0291-013	150		0291-030	250
			0291-021	200		0291-048	300
	0,05 mm/m		0291-099	150		0291-129	300
			0291-102	200			
	0,02 mm/m		0291-056	150		0291-072	250
			0291-064	200		0291-081	300

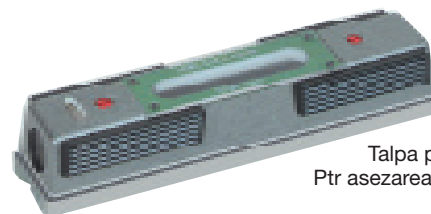

Talpa prismatica
Ptr asezarea pe arbori

0292-... NIVELE CADRU DE PRECIZIE

Conform DIN 877, carcasa robusta din fonta speciala, 3 fete slefuite prismatic, lacuite, cu nivela longitudinalina si transversala, protectie izolatoare ptr. maini; in cutie de lemn

RG	Sensibilitate	Pret brut	Art. Nr.	Lungime in mm	Pret brut	Art. Nr.	Lungime in mm
2	0,10 mm/m		0292-087	100		0292-028	200
			0292-010	150			
	0,05 mm/m		0292-079	200			
			0292-044	150		0292-061	250
	0,02 mm/m		0292-052	200			

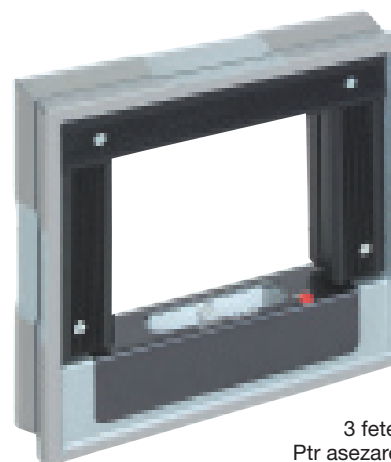

3 fete prismatice
Ptr asezarea pe arbori

Cu certificat de verificare conform ISO 9000 la comanda



Nivele cu bula de aer special ptr domeniul de constructii
vezi grupa "F" din catalog respectiv cuprinsul

Rulete de masurat perimetre

5526-... LERA DE TRASARE »TALMETER«

Cotarea exacta, mecanica a tuturor cotelor exterioare si interioare pana la 2,1 m resp. 3,1 m si trasarea direct pe piesa; retragerea prin apasarea butonului;
Ruleta cu lama de otel, subtire, calita = limitator/opritor la masurare respectiv muchie de trasare la transmiterea lungimilor

Clasa II conf. norma- EG

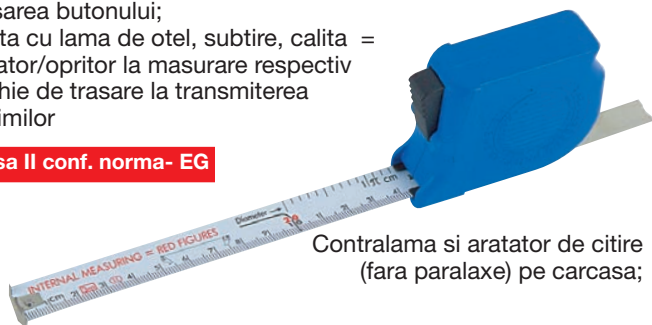

Contralama si aratator de citire (fara paralaxe) pe carcasa;

Limba de masurare aflata la carcasa, de lungime 10 cm, cu lama, rulabila, ptr. masurarea si trasarea cotelor interioare

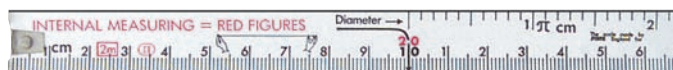
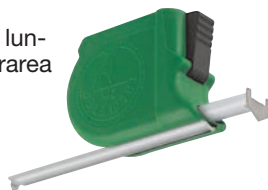

Diviziune proprie ptr citire directa- Ø, prin masurarea perimetrului;
Precizia diviziunii : 0,3 mm pe 2 m

RG	Pret brut	Art.Nr.	Lungime/m	Pret brut	Art. Nr.	Lungime/m
3		5526-019	2		5526-027	3

0222-... Ruleta de masurare (PIMETER)

Ruleta alba, partea frontala cu diviziune milimetrica sus si jos



Partea din spate cu diviziune Pi =
Citirea directa a diametrului

RG	Pret brut	Art. Nr.	Lungime in m	Latimea benzii in mm	Executie
2		0222-062	2	10	Banda de masurare diviziuni, pana la cca. Ø 636 mm

0284-... CIRCUMETER-RULETA PTR. PERIMETRE (PIMETER)

conf. DIN 866/2, cu scala milimetrica si in toli, precizie 1/10 mm

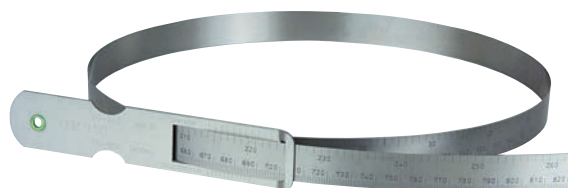

Ptr masurarea perimetrului si citirea simultana a diametrului

RG	Pret brut	Art.Nr.	Dom. de masurare diametru/ mm	Dom. de masurare Ø / mm
2		0284-017	60 - 950	20 - 300
		0284-025	940 - 2200	300 - 700
		0284-033	2190 - 3460	700 - 1100
		0284-050	3450 - 4720	1100 - 1500
		0284-068	4710 - 5980	1500 - 1900
		0284-076	5960 - 7230	1900 - 2300

5595-... TELEMETRU CU LASER ptr. masurarea comoda, fara atingeri a distantelor

Tehnica de masurare moderna sigura si comoda!

pana la 50 m; IP 54;
Art. Nr. 5595-088



Pentru masuratori fara atingere !

Poza:
pana la 100 m; IP 54;
Art. Nr. 5595-070



ideal ptr. constructori de interioare, arhitecti, tehnicieni constructori etc. Deservire simpla, rezultate rapide de masurare
Masoara de la muchia frontala a aparatului sau muchia din spate
Vizualizarea exacta si a suprafetelor curbate
Se poate renunta la toate ruletele, telescoapele etc.
Masoara maxim pana la 50, 100 resp 200 m distanta
Protejat impotriva prafului si a apei IP 54

RG	Pret brut	Art. Nr.	Dom. masurare/m precizia masurarii/mm	Executie
100		5595-088	0,05 - 50 +/- 1,5	Model 1: masurarea lungimilor, calcularea volumelor si a suprafetelor; cu filet pt. stativ; necesita 4 baterii AAA
		5595-070	0,05 - 100 +/- 3	Model 2: masurarea lungimilor, calcularea suprafetelor, volumelor si a incaperilor; masurare-Min/Max. Adunare/Scadere cu nivela integrata; necesita 3 baterii AAA
		5595-053	0,05 - 200 +/- 3	Model 3: la fel ca Model 2 are in plus pentru masurari de distanta directe: declansator propriu, detector de tevi, filet pt. stativ si piesa finala multifunctionala
		5595-126		Stativ pentru Modelul 1 si Modelul 3

Rulete (topografice)

Carlig nou cu capat glisant 1 mm, ptr masuratori exacte interioare si exterioare, protejeaza ruleta pe intreaga latime; ruleta este nituita de 3 ori, sigura in privinta ruperii si gliseaza usor



nituit
de 3 ori

Toate ruletele de calitate "Maxima" sunt cu omologare de tip CE, verificate, cu marcaj conform prescriptiilor CE: Precizie maxima de masurare garantata

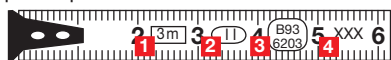

1 lungimea benzii 2 clasa de precizie 3 omologare CE 4 producator

Tolerante la lungimi ptr cote masurabile cu ruleta (lungime totala)

precizii	1 m	2 m	3 m	5 m	7 m
JIS = Standard japonez	+/- 0,3	+/- 0,4	+/- 0,5	+/- 0,7	+/- 0,9
Clasa II norma-EG	+/- 0,5	+/- 0,7	+/- 0,9	+/- 1,3	+/- 1,9

0222-... »RULETE „STABIL-KOMPAKT“

Banda lata de masurare, din cel mai bun otel de arcuri, foarte rezistent; scala neagra inchis pe fond deschis = se poate citi bine. Diviziune in milimetri in fata, sus si jos; Carcasa foarte compacta din plastic rezistent, retragere automata



Ideal pentru masurari de inaltime!

Buton de oprire

Banda de masurare nu se indoiaie

cu clips pentru cureaua si cordon de tinere



noul
carlig de alunecare

Clasa II conf. norma- EG

RG	Pret brut	Art.Nr.	Lungime in m	Latimea benzii in mm	Executie
2		0222-810	3	16	cu cordon de tinere si clips pentru cureaua carlig de alunecare cu magnet
		0222-828	5	19	
		0222-836	8	25	

0222-... »RULETA CU MAGNET

Ptr. masurari facute de un singur om: Carligul magnetic se tine de metal si se trage, nu se indoiaie, nu se rasuceste



RG	Pret brut	Art. Nr.	Lungime in m	Latimea benzii in mm	Executie
2		0222-810	3	16	cu cordon de tinere si clips de cureaua, carlig de alunecare cu magnet
		0222-828	5	19	
		0222-836	8	25	

0222-... » RULETA „HANDY“

carcasa dura, rotunjita, extra mica si compacta



Mica si usor de manevrat, se poate purta oriunde!

Buton de oprire

ruleta emailata, nu se indoiaie



noul
carlig de alunecare

Clasa II conf. norma-EG

RG	Pret brut	Art.Nr.	Lungime in m	Latimea benzii in mm	Executie
2		0222-402	3	13	cu tasta stop Accept PAN II

0222-... »RULETE BESTSICHT

banda de masurare lata din cel mai bun otel de arcuri, nu se indoiaie usor, cu scala neagra pe fond deschis = citire usoara, in fata, sus si jos impartire milimetrica; carcasa compacta din material plastic foarte rezistent; rularea inapoi este automata



Citire buna datorita cifrelor mari! Ideal pentru masurari de inaltime!

Buton de oprire

Banda de masurare foarte lata si stabila ptr masuratori de inaltime, cu cifre mari

cu clips pentru cureaua si cordon de tinere



noul
carlig de alunecare

Clasa II conf. norma- EG

RG	Pret brut	Art.Nr.	Lungime in m	Latimea benzii in mm	Executie
2		0222-771	3	16	cu cordon de tinere si clips pentru cureaua, material rezistent la indoiri
		0222-780	5	19	
		0222-798	8	25	

Banda de masurare lata, din otel de arcuri, foarte rezistent la indoire, scala neagra inchis pe fond deschis = se poate citi bine Diviziune in milimetri in fata, sus si jos; Carcasa foarte compacta din plastic rezistent, retragere automata



Compact, rezistent la indoire si magnetic

Buton de oprire

banda de masurare nu se indoiaie

Cu clips ptr cureaua si cordon de tinere



Carlig glisant nou cu magnet dublu de aderenta

Clasa II conf. norma- EG

0222-... »RULETA RUBBER CU CARCASA DUBLA

Banda de masurare lata, rezistenta la flambaj, din otel de arcuri foarte bun, galben, acoperit cu nylon=mat si rezistent la frecare, diviziune in milimetri in fata, sus si jos; carcasa din plastic rezistent, imbracat in cauciuc, retragere automata



Se poate citi mai bine, mai rezistenta !

Buton de oprire

cu clips pentru curea

banda de masurare mata, deosebit de rezistenta la frecare; mata dar sigura impotriva ruginii

Clasa II conf. norma CE

Carlig de alunecare

RG	Pret brut	Art. Nr.	Lungime in m	Latime banda in mm	Executie
2		0222-739	3	13	banda de masurare, acoperita cu nylon carcasa imbracata in cauciuc
		0222-763	3	16	
		0222-747	5	19	

0222-... »RULETA CU MAGNET

Banda de masurare lata, din otel arc, foarte rezistent la flambare, scala neagra inchis pe fond deschis = se poate citi bine Diviziune in milimetri in fata, sus si jos; Carcasa foarte compacta din plastic rezistent, retragere automata



Compacta, rezistenta la flambaj !

Buton de oprire

Banda de masurare lata rezistenta la flambaj, mata

cu clips pentru curea si cordon de tinere

clasa II conform EG-Norm

ideal si pentru parchie magnetica-mica

noul carlig de alunecare cu magnet dublu



Carligul se tine de metal si se trage: masurare facuta de un singur om!

RG	Pret brut	Art. Nr.	Lungime in m	Lat. benzii in mm	Executie
2		0222-810	3	16	cu cordon de tinere si clips pentru curea, carlig de alunecare cu magnet
		0222-828	5	19	
		0222-836	8	25	

0222-... GENTI CU CUREA PTR. RULETE

Usor, confortabil
Cu inchizator cu scai
Si bucla ptr curea



RG	Pret brut	Art. Nr.	pentru rulete	Pret brut	Art. Nr.	pentru rulete
3		0222-542	pana la 5 m		0222-551	pana la 10 m

0222-... RULETA »LONGLIFE«

Banda de masurat din cel mai bun otel de arcuri, lacuit de culoare deschisa, diviziune milimetrica sus si jos, diviziune exacta a scalelor pe fond deschis, carcasa ABS rezistenta cu scala de cote interioare, muchii rotunjite, tasta automata de oprire rapida si retragere automata

Buton de oprire rapida

Clasa II conf. norma- EG



Cordon de tinere

Mai bun, mai stabil: pur si simplu perfect!

Carlig de alunecare

RG	Pret brut	Art. Nr.	Lungime in m	Latimea benzii in mm	Executie
2		0222-500	2	13	cu oprire rapida Automata
		0222-518	3	13	
		0222-526	5	16	

0222-... »PANORAMA« RULETA cu fereastra de vizualizare

Banda de masurare din cel mai bun otel de arc, galben, lacuit, diviziune milimetrica sus si jos; carcasa rezistenta din plastic, fereastra amplasata sus = citire directa la masuratori interioare



Buton de oprire

Ideal pentru masurari interioare!



Carlig de alunecare

RG	Pret brut	Art. Nr.	Lungime in m	Lat. benzii in mm	Executie
2		0222-089	3	13	cu tasta de oprire automata

Tolerante la lungimi ptr rulete (lungime totala)

Precizie/mm la lungimea benzii	1 m	2 m	3 m	5 m	7 m
JIS = Standard industrial japonez	+/- 0,3	+/- 0,4	+/- 0,5	+/- 0,7	+/- 0,9
Norme EG clasa II	+/- 0,5	+/- 0,7	+/- 0,9	+/- 1,3	+/- 1,9

0222-... RULETA »TOP-TAPE«

Banda de masurare lata, galbena, lacuita, cu diviziune milimetrica, carcasa din plastic rezistent cu retragere automata



Carlig de alunecare

Clasa II conf. norma- EG

RG	Pret brut	Art. Nr.	Lungime in m	Lat. benzii in mm	Executie
2		0222-267	2,0	13	Rulete de masura cu curea cu imprimeul dvs: comanda minima 1000buc (timp de livrare cca 4 luni)
		0222-224	3,5	16	
		0222-241	5,0	16	

0222-... RULETE »CLICK-DOPPELSTOP«

Banda de masurare deosebit de lata, din otel de arc, rezistenta la flambaj; galbena, lacuita, diviziune milimetrica in fata, sus, jos; Carcasa din plastic rezistent si retragere automata;

Cu cordon de prindere si clips ptr curea



Click Doppel

1)»Click-Stop« aretata, ca de obicei

2.)Cu bucla portabila si clips ptr curea

Si mai confortabil!

banda de masurat ce nu se indoiaie

Carlig de alunecare

Clasa II conf. norma-EG

RG	Pret brut	Art.Nr.	Lungime in m	Lat. benzii in mm	Executie
2		0222-704	3	13	cu taste de oprire-duble, carcasa cromata in totalitate, banda nu se indoiaie
		0222-534	3*	13	
		0222-712	5	19	* nou: carcasa cenusie
		0222-721	10	25	

0222-... »RULETE CROMATE

Banda de masurare deschisa, lacuita, cu diviziune in milimetri, carcasa ABS rezistenta, cu retragere automata



Buton de oprire



carlig de alunecare **nou**

Clasa II conf. norm EG

RG	Pret brut	Art.Nr.	Lungime in m	Lat. benzii in mm	Executie
2		0222-313	2	13	cu rulare inapoi automata si buton de oprire
		0222-305	3	13	
		0222-330	5	16	

Multe modele de benzi de masurare cu carlig nou cu capat de glisare 1mm ptr masurare exacta interioara/exteroara, protejeaza banda pe intreaga latime, este sigura impotriva ruperii si gliseaza usor



nituit de 3 ori

0222-... RULETA STANDARD »BLACK«

Banda de masurare cu diviziune milimetrica, executia carcusei „negru”; cu tasta de blocare si retragere automata



Buton de oprire

Pret deosebit!

Carlig de alunecare

Clasa II conf. norma-EG

RG	Pret brut	Art.Nr.	Lungime in m	Lat. benzii in mm	Executie
2		0222-445	2	13	carcasa din material plastic
		0222-411	3	13	
		0222-437	5	16	

0222-... RULETE DE PRECIZIE »CONVEX-STOP«

banda masurare lata, **lacuita alb**, cu diviziune milimetrica, conf. JIS Clasa 1; **carcasa din** material plastic incasabil, retragere **automata**



Cea mai exacta !

Buton de oprire

cordon de prindere

Carlig de alunecare

JIS-clasa 1

(Standard industrial japonez)

RG	Pret brut	Art.Nr.	Lungime in m	Lat. benzii in mm	Executie
2		0222-046	2,0	13	-
		0222-259	3,5	16	
		0222-356	5,5	16	cu cordon pentru mana
		0222-623	7,5	25	cu clips de prins la curea

0222-... RULETE »CHROM-ORANGE«

Banda de masurare deosebit de lata, din otel de arcuri, rezistenta la flambaj;Galben,lacuit, diviziune milimetrica in fata, sus, jos; Carcasa din plastic rezistent si retragere automata;

Vizualizare foarte buna datorita cifrelor mari !



Buton de oprire

Banda de masurat **extra lata** si stabila pt. masurari in inaltime, cu cifre foarte mari



carlig de alunecare **nou**

Clips de curea

Clasa II conf. norma-EG

RG	Pret brut	Art.Nr.	Lungime in m	Lat. benzii in mm	Executie
2		0222-372	3	19	carcasa cromata in totalitate rezistenta la flambaj
		0222-381	5	25	
		0222-399	10	25	

0222-... RULETE SPECIALE »BLACK«

Banda de masurare deosebit de lata, din otel de arcuri, rezistenta la flambaj; Galben, lacuit, diviziune milimetrica in fata, sus, jos; **Carcasa din plastic rezistent si retragere automata;**

Ideal pentru masurari de inaltime!



Buton de oprire

banda masurare care nu se indoiaie

Clips curea

Carlig de alunecare

Clasa II conf. norma-EG

RG	Pret brut	Art.Nr.	Lungime in m	Lat. benzii in mm	Executie
2		0222-101	5	25	carcasa neagra, rezistenta la flambaj
		0222-321	10	25	

0222-... Ruleta in carcasa de metal



Art. Nr. 0222-216
cu carlig pentru alunecare

Art. Nr. 0222-348

RG	Pret brut	Art. Nr.	Lungime in m	Lat. benzii in mm	Executie
2		0222-348	1	6	carcasa: turnata cu placi de zinc cu breloc pentru chei
		0222-216	3	13	Banda galbena cu retragere automata

0222-... RULETE COMPACT

Banda de masurare galbena, lacuita, cu diviziune milimetrica, carcasa din plastic rezistent, negru, cu retragere automata

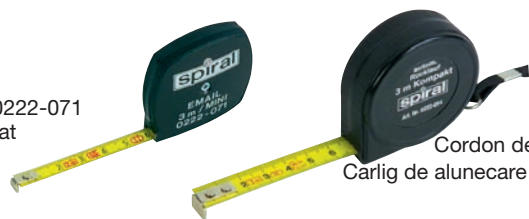

Art. Nr. 0222-071
foarte plat

Cordon de prindere
Carlig de alunecare

RG	Pret brut	Art. Nr.	Lungime in m	Lat. benzii in mm	Executie
2		0222-071	3	7	Mini - foarte plat
		0222-054	3	13	-

0222-... RULETE CU UTILIZARI MULTIPLE »CHROM-STABIL«

Banda de masura de precizie CE II, lata, rezistenta la flambaj, cu diviziune milimetrica, carlig cu capat de glisare si gaura ptr trasare; Carcasa de plastic rezistenta cu tasta de stopare rapida, retragere automata, nivela cu bula de aer si suport prismatic ptr plumb, creion sau laser pointer



4 intr-una
Masurare interioara
Masurare exterioara
Trasare cerc
Nivela

RG	Pret brut	Art. Nr.	Lungime in m	Lat. benzii in mm	Executie
2		0222-429	5,0	19	4 intr-una
		0222-453			laser pointere cu breloc pentru chei, carabina si baterii pt. buton
		0222-488	8,0	25	4 intr-una

5527-... DISPOZITIVE MECANICE PENTRU MASURARI DISTANTE

Roata de masurare cu perimetru 1 m cu afisaj punct de masurare; Tija de ghidare rabatabila cu stativ rabatabil si maner de purtare, maner pt. frana rotii



incapace in rucsac



foarte lizibil, cifre mari, cu buton de pornire la pct. zero

Nou

Ap. masurat-traseu cu tija de ghidare telescopica



Computer de masurare distante (trasee) Cu semnal acustic si presetare trasee de masurare. Si ptr masuratori de viteza pana la 60 km/h



RG	Pret brut	Art. Nr.	executie/tip domeniu de masurare
3		5527-201	Type WALKER Ø roata 318.5mm = ca. 1 m perimetru domeniu de masurare 9999,9 m precizie de masurare 5 cm
		5527-104	Type C10S Ø roata 100 mm domeniu de masurare 100 m precizie de masurare 1 cm
		5527-112	Type B20S Ø roata 200 mm domeniu de masurare 10000 m precizia de masurare 10 cm

RG	Pret brut	Art. Nr.	Tip/executie dom. masurare
3		5527-121	Tip F 20 Ø roata 200 mm r 1000 km / 1-60 km/h precizia masurarii 10 cm

Rulete de masura in capsula



cu capat de banda »A«

0176-... Rulete de masura cu banda galbena

Latime 13 mm; banda de masura din cel mai bun otel de arcuri, galben, divizare milimetrica permanenta, diviziunile negre, cifrele negru/rosu, citire buna, rezistenta buna la uzura;
avantajos ca pret



carcasa dura
cu invelisul manerului-Soft si manivela de inchidere

RG	Pret brut	Art. Nr.	Lungimea benzii in m	Pret brut	Art. Nr.	Lg.benzii in m
2		0176-109	10		0176-133	25
		0176-117	15		0176-141	30
		0176-125	20			

0222-... Rulete de masura cu banda alba

Latime 10 mm, banda de masurat din cel mai bun otel de arcuri, **alb lacuit si uscat in cuptor,** cu divizare milimetrica permanenta, diviziuni de culoare neagra, cifrele negre/rosii, rezistenta buna la uzura



banda din tabla acoperita
cu plastic cu manivela de inchidere

RG	Pret brut	Art. Nr.	L benzii in m	Pret brut	Art. Nr.	Denumire
2		0222-119	10		0222-127	Banda de schimb
		0222-135	15		0222-143	
		0222-151	20		0222-160	
		0222-178	25		0222-186	
		0222-194	30		0222-208	
		0222-275	50		0222-283	

0176-... Rulete de masura cu banda alba

latime 13 mm, executata in mod etalonat; banda din cel mai bun otel de arcuri, **alb lacuit si uscat in cuptor,** cu divizare milimetrica permanenta, diviziuni de culoare neagra, cifrele negre/rosii, foarte rezistente la uzura

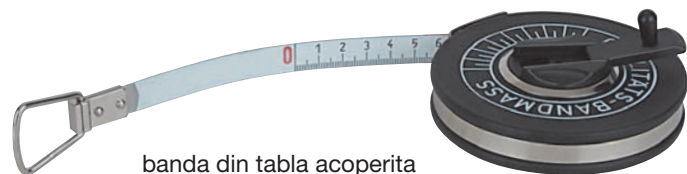

banda din tabla acoperita
cu plastic si stabila cu manivela de inchidere

RG	Pret brut	Art. Nr.	L benzii in m	Pret brut	Art. Nr.	L benzii in m
2		0176-010	10		0176-044	25
		0176-028	15		0176-052	30
		0176-036	20		0176-061	50

0177-... Rulete de masura cu banda inoxidabila

Latime 13 mm, banda de din cel mai bun otel de arcuri **inoxidabil,** diviziuni albe pe fond inchis, **gravare in relief;** diviziuni pana la 10 mm, apoi in centimetri, decimetri si metri, numarul de metri in fata fiecarui decimetru

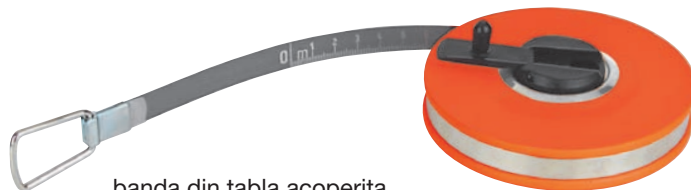

banda din tabla acoperita
cu plastic cu manivela de inchidere

RG	Pret brut	Art. Nr.	Lungimea benzii in m	Pret brut	Art. Nr.	Lg.benzii in m
2		0177-016	10		0177-041	25
		0177-024	15		0177-059	30
		0177-032	20		0177-067	50

0124-... Rulete de masura cu banda din fibra de sticla

Latime 14 mm; banda rezistenta la flambaj, **la rupere, rezistenta la frig,** nici o deformare a benzii in conditii normale de utilizare, citire buna, **tiparit pe ambele parti;** cifrele negre/rosii



carcasa rezistenta
cu invelisul manerului-Soft si manivela de inchidere

RG	Pret brut	Art. Nr.	L benzii in m	Pret brut	Art. Nr.	L benzii in m
1		0124-109	10		0124-141	30
		0124-117	15		0124-150	50
		0124-125	20			

0124-... Rulete de masura cu banda din fibra de sticla

Latime 13 mm; banda din fibra de sticla **acoperita cu PVC;** **rezistenta la flambaj, la rupere, rezistent la frig,** nici o deformare a benzii in conditii normale de utilizare, citire buna, tiparit pe ambele parti

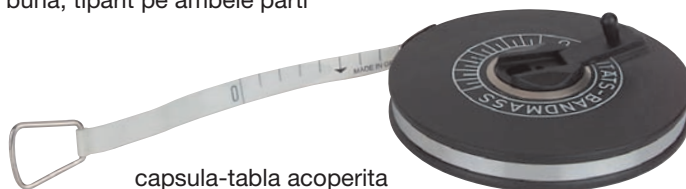

capsula-tabla acoperita
cu plastic cu manivela de inchidere

RG	Pret brut	Art. Nr.	Lungimea benzii in m	Pret brut	Art. Nr.	Lungimea benzii in m
1		0124-010	10		0124-044	25
		0124-028	15		0124-052	30
		0124-036	20		0124-061	50

Rulete de masura cu cadru



cu capat de banda »A«

0178-... Rulete de masurat cu cadru galben

Pret avantajos Latime 13 mm, banda din cel mai bun oțel de arcuri, **galben**, cu divizare milimetrica permanenta, diviziuni de culoare neagra, cifrele negru/rosu, rezistent la uzura



cadru din ABS rezistent
cu maner confortabil si manivela ce se pliaza

RG	Pret brut	Art. Nr.	Lungimea benzii/m
2		0178-152	20
		0178-161	30
		0178-179	50 (cu doua cadre)

0178-... Rulete de masura cu cadru alb

Latime 13 mm, banda din cel mai bun oțel de arcuri, **alb lacuit si uscat in cuptor**, cu divizare milimetrica permanenta, diviziuni de culoare neagra, cifrele negru/rosu, rezistent la uzura



Cadru din metal usor, maner de plastic oblic, manivela lunga de inchidere

Art. Nr. 0178-055 cu cadru de alama, maner de lemn, manivela lunga de inchidere

RG	Pret brut	Art. Nr.	Lungimea benzii/m	Pret brut	Art. Nr.	Articol
2		0178-012	20		0178-063	banda de rezerva
		0178-021	25		0178-071	
		0178-039	30		0178-080	
		0178-047	50		0178-098	
		0178-055	100			la cerere

0179-... Rulete de masura cu cadru inoxidabil

Latime 13 mm, banda din cel mai bun oțel de arcuri, **inoxidabil**, diviziuni albe pe fond inchis, **gravare in relief**, cu divizare milimetrica permanenta; fiecare centimetru, decimetru si metru sunt notati cu cifre, numarul de metri in fata fiecarui decimetru



Cadru din metal usor cu maner din plastic, oblic si manivela de oprire lunga

RG	Pret brut	Art. Nr.	Lungimea benzii/m	Pret brut	Art. Nr.	Articol
2		0179-019	20		0179-051	banda de rezerva
		0179-027	25		0179-060	
		0179-035	30		0179-078	
		0179-043	50		0179-086	
		0179-094	100			la cerere

0193-... Rulete de masura cu cadru din fibra de sticla

Latime 13 mm, banda din fibra de sticla **acoperita cu PVC**; rezistenta la flambaj, rupere, rezistent la frig, nici o deformare a benzii in conditii normale de utilizare, citire buna, tiparita pe ambele parti, cu divizare in centimetri;



Cadru din metal usor triunghiular, cu maner de plastic oblic si manivela lunga de oprire

RG	Pret brut	Art. Nr.	Lungimea benzii/m
2		0193-011	20
		0193-020	25
		0193-038	30
		0193-046	50

0125-... Ruleta cu spate autoadeziv pentru lipirea pe masini, aparate etc.

otel, **acoperit cu poliamida**, galben, cu folie autoadeziva pe partea din spate, pentru lipirea pe masini, bancuri de lucru etc.; diviziuni -mm in partea de jos, cm/dm-notare cu cifre in negru, cifrele pentru metri de culoare rosie se repeta in fata fiecarui decimetru



Notare cu cifre de la stanga la dreapta



Notare cu cifre de la dreapta la stanga

RG	Pret brut	Art. Nr.	Notare cu cifre	Lungimea benzii in m	Lat. benzii in mm
2		0125-105		1	13
		0125-113	de la stanga la dreapta	2	
		0125-121		3	
		0125-130		4	
		0125-148		5	
		0125-202	de la dreapta la stanga	1	13
		0125-211		2	
		0125-229		3	
		0125-237		4	
		0125-245		5	

0297-.. METRU PENTRU TAMPLARIE DIN FIBRA DE STICLA

Componente din plastic rezistent la rupere, cu suprafata mata, **prinderea componentelor** cu caneluri in cruce; divizare milimetrica, scala nu se zgarie

RG	Pret brut	Art. Nr.	Lungimea / m	Pret brut	Art. Nr.	Lungimea / m
2		0297-011	1		0297-020	2

0227-... METRU PENTRU TAMPLARIE DIN METAL USOR

Componente din aliaj special-**aluminiu**, divizare milimetrica si prinderea articulatiilor cu arcuri

RG	Pret brut	Art. Nr.	Lungimea / m	Pret brut	Art.Nr.	Lungimea / m
2		0227-021	1		0227-013	2

0228-.../0229-... METRU PENTRU TAMPLARIE DIN LEMN

cu divizare milimetrica

RG	Pret brut	Art. Nr.	Executie	Lungimea
2		0229-016	cu articulatie pe arcuri	2 m
		0228-010	cu articulatie pe arcuri	1 m

5529-... TIJA TELESCOPICA GRADATA »MESSFIX« cu citire directa

Tija telescopica dreptunghiulara, care poate fi extrasa de la lungimea initiala pana la lungimea masurata; acea lungime extrasa se poate citi direct printr-un cadran; incorporata cu banda de masurare robusta, cu arc foarte tare de rulare

Utilizare: pentru masurari interioare rapide pe santiere etc.

RG	Pret brut	Art.Nr.	Lg. masurata / m	Lungimea intercalata / m	Greutate / kg
3		5529-018	3	0,70	1,0
		5529-026	5	1,07	1,8
		5529-034	8	1,35	4,0

5530-... » Tije telescopice

Liniar telescopic din aluminiu, care se poate extrage de la lungimea initiala pana la lungimea masurata;

Diviziunea masurii: cu divizare milimetrica permanenta (in primul metru) partile extrase de cate 1m (fiecare parte extrasa se blocheaza cu zavor dupa 1m);

RG	Pret brut	Art. Nr.	Lg. masurata / m	Lungimea intercalata / m
3		5530-016	5	1,13

Cu semn de etalonare EG!

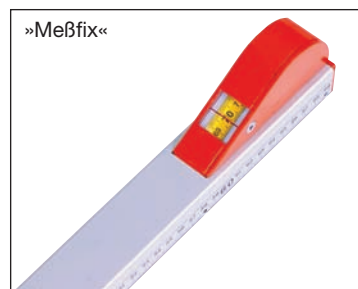
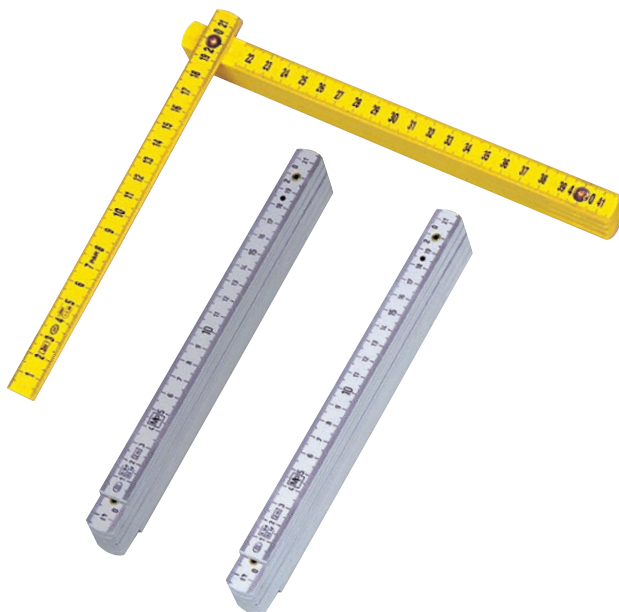

»Messfix«

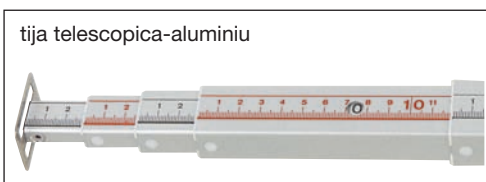

tija telescopica-aluminiu



Nivele de apa cu bule de aer si aparate de masurat special pentru domeniul de constructii si de montare vezi grupa »F« din catalog, respectiv cuprinsull!



0250-.../0252-.../0276-... Ace de trasat

Executie din carbura: se pot slefui din nou, pentru o viata lunga

usor **manevrabil:** executie metalica in forma de pix, cu ac de trasat ce se poate inlocui

Art. Nr. 0252-018,
Pret brut
RG 2



Ac de trasat-HM-de schimb; Art. Nr. 0252-026, Pret brut RG 2

Executie compacta in **forma de pix**, cu ac de trasat ce se poate inlocui din **carbura** ;

Art. Nr. 0252-051,
Pret brut RG 2



Ac de trasat din carbura cu coada cu 6 muchii si clips;

Art. Nr. 0276-014,
Pret brut RG 2



Ac de trasat-CV cu varf calit, drept, manerul cu striatii pentru a nu aluneca, **pret avantajos**

Art. Nr. 0250-015, Pret brut RG 2



Ac de trasat din carbura in forma clasica, cu varf drept si curbat deasemenea cu maner cu striatii pentru a nu aluneca;

Art. Nr. 0250-104, Pret brut RG 2



Ac de trasat-CV in forma clasica, cu varf drept si curbat deasemenea cu maner cu striatii pentru a nu aluneca; **pret avantajos**

Art. Nr. 0250-023, Pret brut RG 2



Trasor greu, extra robust, din carbura pentru cea mai grea trasare; 6-muchii, 8 mm;

Art. Nr. 0276-103, Pret brut RG 2



0283-... Trasoare- autopercutante

din cel mai bun otel , **slefuit fin**, tija antiderapanta, cu reglarea intensitatii de soc si inlocuibil cu rezerva

Executie de precizie:
125 mm Lungimea, 15 mm Ø
Art. Nr. 0283-088,
Pret brut RG 2



Varf de schimb Art. Nr. 0283-096, Pret brut RG 2

Executie de precizie:
140 mm Lungimea, 19 mm Ø
Art. Nr. 0283-100,
Pret brut RG 2



Varf de schimb; Art. Nr. 0283-118, Pret brut RG 2

Executie-standard:
130 mm Lungimea,
20 mm Ø
Art. Nr. 0283-045,
Pret brut RG 2

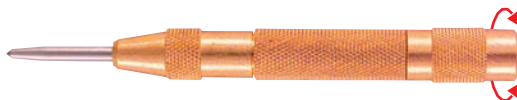

0212-... »MAXIMA« Seturi de trasat-HM

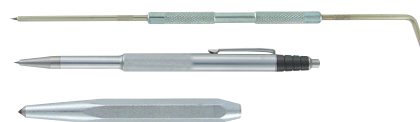

Set din carburi - de trasare-, gravare-, centrare:
(Art. Nr. 0252-018 + 0250-104 + 0276-103 + Spray de trasare)

Art. Nr. 0212-016,
Pret brut RG 2



Set-carburi- de trasare si gravare:
(Art. Nr. 0252-018 + 0250-104 + spray de trasare)

Art. Nr. 0212-024, Pret brut RG 2



2717-... Vopsele-trasare, albastru



se usuca foarte repede, **albastru mat**, vopseaua nu se decojeste, se poate folosi in orice moment

Spray de trasat, albastru, 400 ml;
Art. Nr. 2717-018,
Pret brut RG 123

Vopsea-de trasat, albastru, sticla, 1 litru;
Art. Nr. 2717-051,
Pret brut RG 123

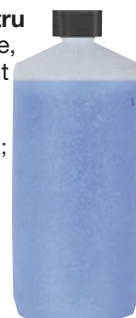

0150-... Pasta de tusare, albastra

cel mai bun efect de contrast prin culoare albastru

Pasta de tusare, albastru, tub, 80 ml;
Art. Nr. 0150-029, Pret brut RG 2



2745-... Dizolvant pentru culorile de trasare



Spray-dizolvant, cca. 500 ml;
Art. Nr. 2745-011,
Pret brut RG 123

Dizolvant, butoi 5 litri
Art. Nr. 2745-208
Pret brut RG 123

0298-... SUBLER PT. TRASAT DIN ALUMINIU

cu suprafata de oprire lata; corp turnat din aluminiu, capat din otel slefuit fin, **cursor din otel**



cu diviziuni lizibile foarte usor, **scala 1/10 mm**

RG	Pret brut	Art. Nr.	Lg. masurata in mm	Pret brut	Art. Nr.	Lg. masurata in mm
2		0298-018	100		0298-026	200

0180-... COMPAS CU BARA PENTRU TRASARE DE PRECIZIE



din teava de otel cu nut de ghidare, varfuri ce se pot schimba divizarea masurii si reglaj fin; scala 1/10

RG	Pret brut	Art. Nr.	Lungimea in mm	Pret brut	Art. Nr.	Lungimea in mm
2		0180-017	1000		0180-041	3000
		0180-033	2000			

WD 40

5 produse in 1:

- **curatitoare de calitate**
- cele mai bune calitati de aplicare = **inlatura** rapid umiditatea
- lubrifiant eficient
- desfac piulite si suruburi ruginite
- **protejeaza impotriva ruginii si a corozionii**

Rezolva orice: ● fara silicon si rezistente la temperatura

● nu ataca materialele sintetice si vopsele

Spray, 200 ml; Art. 2738-015 / RG 121

Spray, 400 ml; Art. 2738-023 / RG 121

Canistra, 5 litri; Art. 2739-011 / RG 121

Canistra, 25 litri; Art. 2739-020 / RG 121



Cea mai buna ingrijire pentru uneltele dumneavoastra!

5526-.. »TALMETER« CALIBRU pentru toate masuratorile interioare si exterioare precum si pentru trasat

pentru masurarea mecanica exacta a tuturor dimensiunilor **exterioare si interioare** pana la 2,1 m resp. 3,1 m si trasarea ulterioara direct cu unealta pe piesa de lucru;

buton pentru rularea inapoi a benzii; banda cu lame de otel subtiri, **intarite** (folosesc ca opritor la masurare si ca **lame de trasat** la transmiterea de lungimi masurate sau reglate);

Lama opusa carcasei, in plus un aratator de citire (fara paralaxa); langa carcasa este prevazuta banda de masurat de 10 cm care se scoate afara, deasemenea prevazuta cu lama, pentru masurarea **si trasarea de masuratori interioare;**

RG	Pret brut	Art. Nr.	Lungimea/m	Pret brut	Art. Nr.	Lungimea/m
3		5526-019	2		5526-027	3

5522-... SUBLER DE TRASAT CU GREUTATE

cromat mat inoxidabil, scala negru inchis = **citire foarte buna**, cu muchie **de trasare intarita**, latime 40 mm



Cel mai bun si cel mai FOLOSIT !

RG	Pret brut	Art. Nr.	Dom. de masurare in mm	Pret brut	Art. Nr.	Dom. de masurare in mm
2		5522-013	200			300
		5522-021	250			

5523-... SUBLER TRASOR

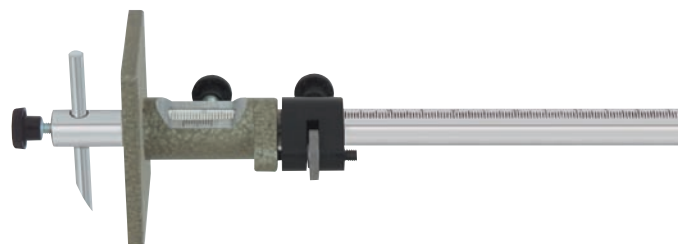

scala 1/10 mm, cu reglaj fin, ac de trasat calit, placa opritoare mare; **tija de masurat rotunda cu nut de ghidare** si divizare milimetrica

RG	Pret brut	Art. Nr.	Dom. de masurare in mm	Pret brut	Art. Nr.	Dom. de masurare
2		5523-010	300		5523-028	500
		5523-036				ac de rezerva

0223-SUBLER TRASOR DE PRECIZIE

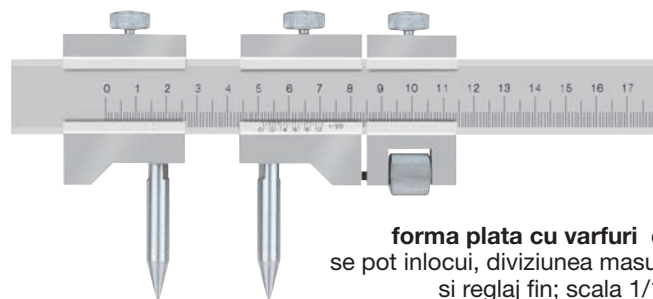

forma plata cu varfuri ce se pot inlocui, diviziunea masurii si reglaj fin; scala 1/10

RG	Pret brut	Art. Nr.	Lungimea in mm	Pret brut	Art. Nr.	Lungimea in mm
2		0223-018	500		0223-034	1500
		0223-026	1000		0223-042	2000

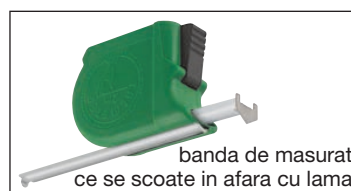

banda de masurat ce se scoate in afara cu lama

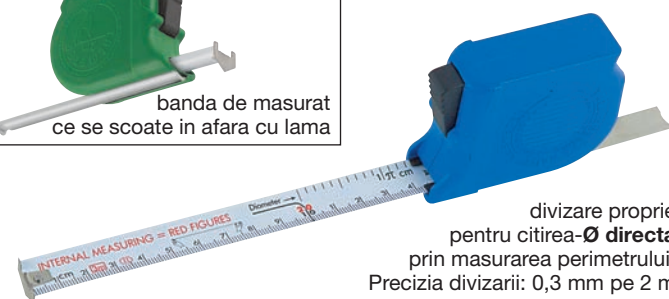

divizare proprie pentru citirea-Ø **directa** prin masurarea perimetrului; Precizia divizarii: 0,3 mm pe 2 m



0225-... COMPAS PENTRU ATELIER

cu nit din otel,
brate rezistente cu 4-muchii,
varfuri calite, polizate

RG	Pret brut	Art. Nr.	Lungimea / mm
2		0225-011	150
		0225-029	200
		0225-037	250
		0225-045	300
		0225-053	500



0215-... COMPAS PENTRU ATELIER

cu nit din otel,
brate rezistente cu 4 muchii,
varfuri calite, polizate

RG	Pret brut	Art. Nr.	Lungimea / mm
2		0215-015	150
		0215-023	200
		0215-031	250



0217-... COMPAS DE INTERIOR

cu nit din otel,
brate rezistente cu 4 muchii,
varfuri calite, polizate

RG	Pret brut	Art. Nr.	Lungimea / mm
2		0217-018	150
		0217-026	200
		0217-034	300



0216-... COMPAS DE EXTERIOR

cu nit din otel,
brate rezistente cu 4 muchii,
varfuri calite, polizate

cu impartire pe scala la cerere!

RG	Pret brut	Art. Nr.	Lungimea / mm
2		0216-011	150
		0216-020	200
		0216-038	300
		0216-046	500
		0216-054	600



0218-... COMPAS DE TRASAT CU SURUB DE REGLARE

cu piulita de strangere rapida, din otel,
brate rezistente cu 4 muchii, varfuri
calite, polizate

RG	Pret brut	Art. Nr.	Lungimea / mm
2		0218-014	100
		0218-022	150
		0218-031	200
		0218-049	250



0219-... COMPAS INTERIOR CU SURUB DE REGLARE

cu piulita de strangere rapida, din otel,
brate rezistente cu 4-muchii,
varfuri calite, polizate

RG	Pret brut	Art. Nr.	Lungimea / mm
2		0219-011	100
		0219-029	150
		0219-037	200
		0219-045	250



0220-... COMPAS EXTERIOR CU SURUB DE REGLARE

cu piulita de stangere rapida, din otel,
brate rezistente cu 4 muchii,
varfuri calite, polizate

RG	Pret brut	Art. Nr.	Lungimea / mm
2		0220-019	100
		0220-027	150
		0220-035	200
		0220-043	250



0247-... AC DE TRASAT PARALEL UNIVERSAL

cu suport prismatic, fara impartire a masurii, cu bara rotunda mobila, ac de trasat reglabil, cu reglare fina

Utilizare: special pentru producatorii de unelte

RG	Pret brut	Art. Nr.	Inaltimea de masurat/ mm
2		0247-014	300



0273-... DISPOZITIV PENTRU MASURAREA INALTIMII

scala reglabila, **suprafetele de masurat cromate**, cu reglare de citire, ac de trasat cu varf- **HM**, picior de trasare mare, stabil cu suprafata lepuita;

Avantaj: **I pozitionare-0** posibila prin bara de masurare cu reglare, de aceea lipsesc si operatiile de calcul

RG	Pret brut	Art. Nr.	Dom. de masurare / mm	Executie	scala / mm
2		0273-015	300	cu picior cu colturi	1/50
		0273-104	500	cu picior cu colturi	1/50
		0273-023 0273-112	Ac de trasat de schimb pentru Art. Nr. 0273-015 Ac de trasat de schimb pentru Art. Nr. 0273-104		

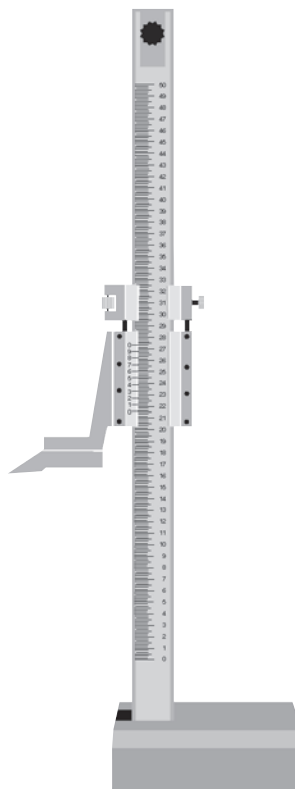

Maxima

- I bara scalara reglabila = reglare a masurii de diferenta
- I cromat
- I lupa panoramica

5583-... »APARATE DIGITALE PENTRU MASURAREA INALTIMILOR

Executie: constructie stabila cu picior de fonta greu pentru o pozitionare sigura; in cutie de lemn;

- Avantaje:
- I Afisaj-LCD
 - I punct-zero reglabil arbitrar
 - I comutare mm / toli
 - I Reglare prestabilita (valori limita + si -)
 - I tasta de retinere a valorilor - memorarea rezultatului masurarii la mutarea acului de trasat

RG	Pret brut	Art.Nr.	Dom. de masurare/ mm	citire mm / tol	Precizie / mm
141		5583-012	0 - 300	0,01 / 0,005	+/- 0,04
		5583-021	0 - 500	0,01 / 0,005	+/- 0,05
		5583-055 5583-063	Ac de trasat de schimb pentru »Digi-Max 300« – Art. Nr. 5583-012 Ac de trasat de schimb pentru »Digi-Max 500« – Art. Nr. 5583-021		

Maxima

- I afisaj electronic LCD
- I iesire de date RS 232
- I cea mai mare viteza de procesare

- I cea mai mare precizie
- I reglare fina
- I surub de prindere (= valoare limita + si -)



5510-... INTERFATA PENTRU TOATE INSTRUMENTELE DE MASURA DIGITALE »MAXIMA-DIGIMAX«

Utilizare: pentru transmiterea de date la PC

Interfata Maxima prin cablul de legatura De la dispozitivul de masurare la PC: Art. Nr. 5510-104, pret brut. RG 141

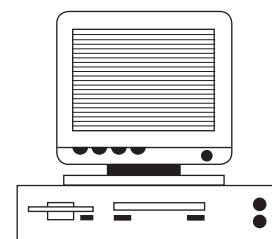
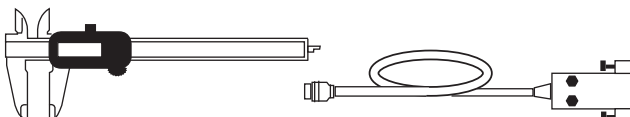

0224-... RIGLE FLEXIBILE FINE INOXIDABILE, EXECUTIE INGUSTA

rigle de masura flexibile, mate, inoxidabile executie ingusta



DIN 2768m = Clasa EG 2

RG	Pret brut	Art.Nr.	Lungimea in mm	Latime x putere/mm	Impartire jos - sus
2		0224-049	150	13 x 0,5	mm - 1/2 mm
		0224-057	200	13 x 0,5	mm - 1/2 mm
		0224-014	300	13 x 0,5	mm - 1/2 mm
		0224-022	500	18 x 0,5	mm - mm
		0224-031	1000	18 x 0,5	mm - mm
		0224-065	1500	18 x 0,5	mm - mm
		0224-073	2000	18 x 0,5	mm - mm
		0224-081	3000	18 x 0,5	mm - mm

0275-... RIGLE DE MASURAT FLEXIBILE DIN INOX, EXECUTIE LATA

rigle de masura flexibile, din inox, executie lata

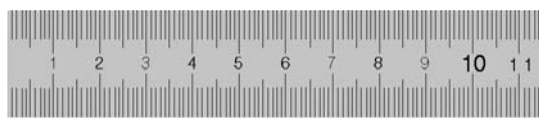

DIN 2768m = Clasa EG 2

RG	Pret brut	Art. Nr.	Lungimea in mm	Latime x grosime/mm	Impartire sus - jos
2		0275-069	300	30 x 1	mm - 1/2 mm
		0275-018	500	30 x 1	mm - 1/2 mm
		0275-026	1000	30 x 1	mm - mm
		0275-077	1500	30 x 1	mm - mm
		0275-034	2000	30 x 1	mm - mm
		0275-042	3000	30 x 1	mm - mm
		0275-051	4000	30 x 1	mm - mm
		cu certificat de verificare conform ISO 9000			
		0275-123	1000	30 x 1	mm - mm
		0275-140	2000	30 x 1	mm - mm

5533-... RIGLE DE SCOALA DIN ALUMINIU

cu divizare milimetrica si tesituri



RG	Pret brut	Art.Nr.	Dimensiuni / mm	Sectiune transversala / mm
2		5533-058	300	50 x 5
		5533-066	600	50 x 5
		5533-074	1000	50 x 5

0231-... RIGLA DE PRECIZIE conform DIN 866/A

cu divizare milimetrica, slefuita cu precizie, cu capete de protectie



cu capat de protectie precizie A

RG	Pret brut	Art. Nr.	Dimensiuni / mm	Sectiune transversala / mm	
2		0231-011	500	30 x 6	
		0231-029	1000	40 x 8	
		0231-037	1500	40 x 8	
		0231-045	2000	50 x 10	
		0231-053	3000	50 x 10	
		cu certificat de verificare conform ISO 9000			
			0231-207	500	30 x 6
			0231-215	1000	40 x 8
		0231-223	1500	40 x 8	
		0231-231	2000	50 x 10	

0231-... RIGLE DE PRECIZIE conform DIN 866/B

cu divizare milimetrica, slefuite fin, fara capete de protectie



Precizie B

RG	Pret brut	Art. Nr.	Dimensiuni / mm	Sectiune transversala / mm	
2		0231-061	500	25 x 5	
		0231-070	1000	30 x 6	
		0231-088	1500	30 x 6	
		0231-096	2000	40 x 8	
		0231-100	3000	40 x 8	
		cu certificat de verificare conform ISO 9000			
			0231-304	1000	30 x 6
			0231-312	2000	40 x 8
		0231-321	3000	40 x 8	

5533-... RIGLE DE ALUMINIU conf. DIN 866/B

fara efect de orbire, cu divizare milimetrica

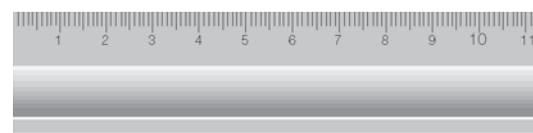

RG	Pret brut	Art. Nr.	Dimensiuni / mm	Sectiune transversala / mm
2		5533-104	500	50 x 5
		5533-112	1000	50 x 5
		5533-121	1500	50 x 5
		5533-139	2000	50 x 5

5532-... RIGLE DE MASURA »CHESTERMAN« DIN OTEL INOXIDABIL, FARA EFECT DE ORBIRE

cu divizare speciala: muchia de sus 1/2 mm si mm intregi
muchia de jos 1/16, 1/32, 1/64 tol

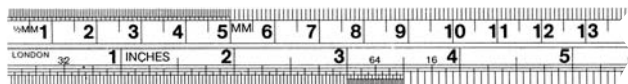

RG	Pret brut	Art.Nr.	Lungimea / mm	Latime x grosime/ mm
2		5532-019	300	28 x 1
		5532-027	500	30 x 1
		5532-035	600	30 x 1
		5532-043	1000	30 x 1

0232-... RIGLA DE VERIFICARE conform DIN 874/00

din otel special, calit, cu muchie de masura foarte fina, lepuita,
protejat impotriva ruginii, tesituri fara efect de orbire, **protec-
tie izolatoare**; in husa de piele

utilizare: pentru verificare (Metoda fantei de lumina)



DIN 874/00

tesitura fara efect
de orbire

RG	Pret brut	Art. Nr.	Lungimea/mm	Pret brut	Art. Nr.	Lungimea/mm	
2		0232-076	75		0232-114	300	
		0232-084	100		0232-122	500	
		0232-092	150		0232-131	800 Inox	
		0232-106	200		0232-149	1000 Inox	
	inoxidabil executie cu certificat de verificare conform ISO 9000						
		0232-157	75		0232-190	300	
		0232-165	100		0232-203	400	
		0232-173	150		0232-211	500	
		0232-181	200				

5533-... RIGLA PENTRU SCOALA conform DIN 874/4

din otel, polizat fin, cu gaura de agatare

Utilizare: pentru lucrari in atelier si legari de carti, etc.



RG	Pret brut	Art.Nr.	Dimensiuni in mm	Sect. transversala in mm	Executie
2		5533-023	500	40 x 5	cu fateta

0233-... RIGLA DE PRECIZIE conform DIN 874/1

Suprafetele de control si marginile sunt slefuite cu precizie,
incepand cu 3000 mm lungimea sectiunii transversale in forma de L



incepand cu 3000 mm lungimea in forma-L



RG	Pret brut	Art.Nr.	Dimensiuni / mm	Sectiune transversala / mm	
2		0233-013	500	40 x 8	
		0233-021	1000	50 x 10	
		0233-030	1500	60 x 12	
		0233-048	2000	70 x 14	
		0233-056	3000	100 x 16	
	cu certificat de verificare conform ISO 9000				
		0233-307	500	40 x 8	
		0233-315	1000	50 x 10	
		0233-323	1500	60 x 12	
		0233-331	2000	70 x 14	

0233-... RIGLE DE PRECIZIE conform DIN 874/2

Suprafetele de control si marginile sunt slefuite cu finete,
incepand cu 4000 mm lungimea sectiunii transversale in forma-l



Utilizare: la montari

RG	Pret brut	Art. Nr.	Dimensiuni / mm	Sectiune transversala / mm
2		0233-064	500	30 x 6
		0233-072	1000	40 x 8
		0233-081	1500	50 x 10
		0233-099	2000	60 x 12
		0233-170	2500	70 x 14
		0233-188	3000	80 x 15
		0233-196	4000	100 x 16

0233-... RIGLE DIN OTEL conform DIN 874/3

Suprafetele de control si marginile sunt slefuite fin, sectiune
transversala dreptunghiulara



RG	Pret brut	Art. Nr.	Dimensiuni / mm	Sectiune transversala / mm
2		0233-111	500	30 x 6
		0233-129	1000	30 x 6
		0233-137	1500	40 x 8
		0233-145	2000	40 x 8
		0233-153	3000	50 x 10

0240-... CORNIER PENTRU FLANSE

din otel special, slefuit



Utilizare: pentru lucrari de instalare pentru ajustarea flansei la lucrari de sudura ale tevilor

RG	Pret brut	Art. Nr.	Dim./mm	Pret brut	Art. Nr.	Dim./mm
2		0240-010	300 x 400		0240-036	500 x 500
		0240-028	400 x 400		0240-044	600 x 600

7037-... ECHER PENTRU TAMPLARIE

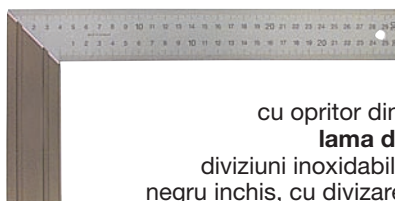

cu opritor din aluminiu si lama din otel calit, diviziuni inoxidabile de culoare negru inchis, cu divizare milimetrica

RG	Pret brut	Art. Nr.	Dim./mm	Pret brut	Art. Nr.	Dim./mm
30		7037-015	250		7037-023	300

7038-... ECHER PENTRU DULGHERIE

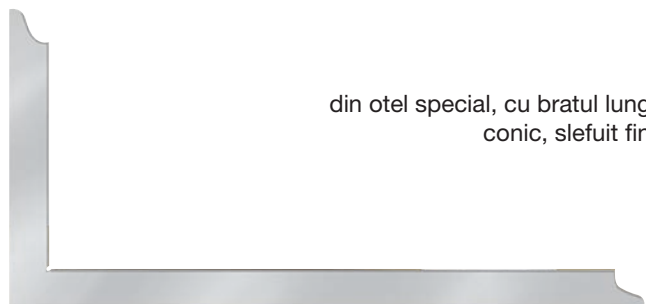

din otel special, cu bratul lung conic, slefuit fin

RG	Pret brut	Art. Nr.	Dim./mm	Pret brut	Art. Nr.	Dim./mm
30		7038-011	600		7038-038	1000
		7038-020	800			

0234-... ECHER DE PRECIZIE conform DIN 875/00

Utilizare: pentru diferite lucrari de verificare (control minutios) si in special pentru producatorii de unelte

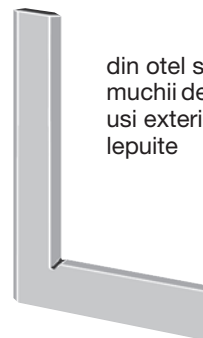

din otel special, **calit**, cu doua muchii de masurat de 45° (interior usi exterior) slefuite la precizie si lepuite

RG	Pret brut	Art. Nr.	Dim./mm	Pret brut	Art. Nr.	Dim./mm	
2		0234-010	50 x 40		0234-044	150 x 100	
		0234-028	75 x 50		0234-052	200 x 130	
		0234-036	100 x 70				
	Executie inoxidabila cu certificat de verificare conform ISO 9000						
		0234-109	75 x 50		0234-125	150 x 100	
	0234-117	100 x 70		0234-133	200 x 130		

0282-.... SET COMPLET

in caseta de lemn



RG	Pret brut	Art. Nr.	formata din	
2		0282-014	1 Echer 40 x 28 mm	
			1 Echer 25 x 20 mm	
			1 echer cu muchii subtiri 75 x 50 mm	
			1 Rigla cu muchie fina 100 mm lungime	

5501-... ECHER conform DIN 875/00

Utilizare: pentru producatorii de unelte

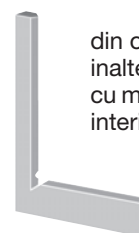

din otel special, **calit**, muchiile inalte si lateralele joase slefuite fin, cu muchie subtire de masurat 45°, interior, muchia de masurat lepuita

RG	Pret brut	Art. Nr.	Dim./mm	Pret brut	Art. Nr.	Dim./mm
2		5501-016	25 x 20		5501-024	40 x 28

0181-... ECHER PLAT INOXIDABIL conform DIN 875/1

din otel **inoxidabil**, partile de masura si cele joase sunt slefuite precis

Utilizare: in constructia de masini si pentru lucrari de cea mai mare precizie



RG	Pret brut	Art. Nr.	Dim./mm	Pret brut	Art. Nr.	Dim./mm	
2		0181-013	100 x 70		0181-064	400 x 265	
		0181-021	150 x 100		0181-072	500 x 330	
		0181-030	200 x 130				
		0181-048	250 x 165				
		0181-056	300 x 200				
	cu certificat de verificare conform ISO 9000						
		0181-200	150 x 100		0181-234	300 x 200	
		0181-218	200 x 130		0181-242	500 x 330	
	0181-226	250 x 160					

0182-... ECHER CU TALPA-INOXIDABIL conform DIN 875/1

din otel **inoxidabil**, partile de masura si cele joase slefuite precis

Utilizare: in constructia de masini si pentru lucrari de cea mai mare precizie



RG	Pret brut	Art. Nr.	Dim./mm	Pret brut	Art. Nr.	Dim./mm	
2		0182-010	75 x 50		0182-061	300 x 200	
		0182-028	100 x 70		0182-079	400 x 265	
		0182-036	150 x 100		0182-087	500 x 330	
		0182-044	200 x 130				
		0182-052	250 x 165				
	cu certificat de verificare conform ISO 9000						
		0182-206	150 x 100		0182-231	300 x 200	
		0182-214	200 x 130		0182-249	500 x 330	
	0182-222	250 x 160					

0235-... ECHER PLAT conform DIN 875/1

din otel special, partile de masura si cele joase slefuite precis

Utilizare: in constructia de masini

RG	Pret brut	Art. Nr.	Dim./mm	Pret brut	Art. Nr.	Dim./mm
2		0235-016	100 x 70		0235-059	300 x 200
		0235-024	150 x 100		0235-067	500 x 330
		0235-032	200 x 130			
		0235-041	250 x 160			

0236-... ECHER CU TALPA conform DIN 875/1

din otel special, partile de masura si cele joase slefuite precis

Utilizare: in constructia de masini si pentru lucrari de cea mai mare precizie

RG	Pret brut	Art. Nr.	Dim./mm	Pret brut	Art. Nr.	Dim./mm
2		0236-012	100 x 70		0236-055	300 x 200
		0236-021	150 x 100		0236-063	500 x 330
		0236-039	200 x 130			
		0236-047	250 x 160			

0235-... ECHER PLAT conform DIN 875/2

din otel special, partile de masura si cele joase slefuite precis

Utilizare: lucrari generale in atelier

RG	Pret brut	Art. Nr.	Dim./mm	Pret brut	Art. Nr.	Dim./mm
2		0235-091	100 x 70		0235-130	300 x 175
		0235-105	150 x 100		0235-148	500 x 250
		0235-113	200 x 130		0235-156	750 x 375
		0235-121	250 x 160		0235-164	1000 x 500

0236-... ECHER CU TALPA conform DIN 875/2

din otel special, partile de masura si cele joase slefuite precis

Utilizare: lucrari generale in atelier

RG	Pret brut	Art. Nr.	Dim./mm	Pret brut	Art. Nr.	Dim./mm
2		0236-098	100 x 70		0236-136	300 x 175
		0236-101	150 x 100		0236-144	500 x 250
		0236-110	200 x 130		0236-152	750 x 375
		0236-128	250 x 160		0236-161	1000 x 500

0235-... ECHER PLAT conform DIN 875/3

din otel special, partile de masura si cele joase slefuite precis

Utilizare: lucrari generale de lacatuserie

RG	Pret brut	Art. Nr.	Dim./mm	Pret brut	Art. Nr.	Dim./mm
2		0235-172	100 x 70		0235-211	300 x 175
		0235-181	150 x 100		0235-229	500 x 250
		0235-199	200 x 130		0235-237	750 x 375
		0235-202	250 x 160		0235-245	1000 x 500

0236-... ECHER CU TALPA conform DIN 875/3

din otel special, partile de masura si cele joase slefuite precis

Utilizare: lucrari generale de lacatuserie

RG	Pret brut	Art. Nr.	Dim./mm	Pret brut	Art. Nr.	Dim./mm
2		0236-179	100 x 70		0236-217	300 x 175
		0236-187	150 x 100		0236-225	500 x 250
		0236-195	200 x 130		0236-233	750 x 375
		0236-209	250 x 160		0236-241	1000 x 500

0238-... ECHER ASCUTIT 45°

conform DIN 875/2 din otel special, muchiile de masura si partile plate slefuite fin

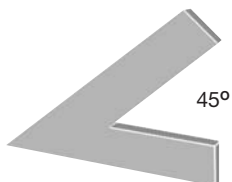

RG	Executie	Pret brut	Art. Nr.	Dim. / mm
2	45°		0238-015	100 x 80
			0238-023	150 x 100
			0238-031	200 x 130
			0238-040	300 x 200

0237-... ECHER OBTUZ 120° si 135°

conform DIN 875/2, din otel special, muchiile de masura si partile plate slefuite fin

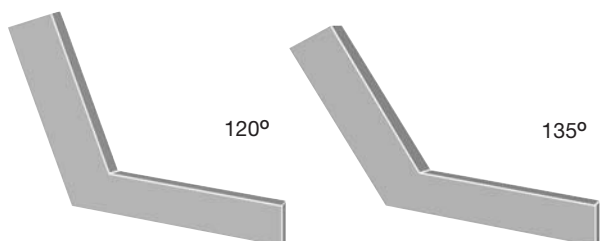

RG	Executie	Pret brut	Art. Nr.	Dim. / mm
2	echer 6 colturi 120°		0237-019	100 x 100
			0237-027	150 x 150
			0237-035	200 x 200
	echer 8 colturi 135°		0237-094	100 x 100
			0237-108	150 x 150
			0237-116	200 x 200

0238-... ECHER CU TALPA 45°

conform DIN 875/2, din otel special, muchiile de masura si partile plate slefuite fin

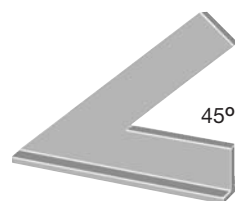

RG	Executie	Pret brut	Art. Nr.	Dim. / mm
2	45°		0238-058	100 x 80
			0238-066	150 x 100
			0238-074	200 x 130
			0238-082	300 x 200

0237-... ECHER OBTUZ CU TALPA 120° si 135°

conform DIN 875/2, din otel special, muchiile de masura si partile plate slefuite fin

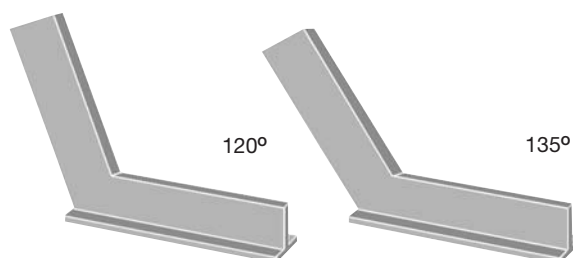

RG	Executie	Pret brut	Art. Nr.	Dim. / mm
2	echer 6 colturi 120°		0237-051	120 x 80
			0237-060	150 x 100
			0237-132	120 x 80
	echer 8 colturi 135°		0237-141	150 x 100
			0237-159	200 x 130
			0237-167	300 X 175

0239-... UNGHI DE REGLARE PT. LACATUSERIE

din otel special, slefuit, brate mobile montabil si fixabil pe orice colt

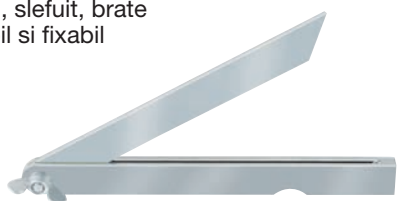

RG	Pret brut	Art. Nr.	Lungimea bratelor/mm	Pret brut	Art. Nr.	Lungimea bratelor/mm
2		0239-011	150		0239-038	250
		0239-020	200			

5534-... ECHER REGLABIL CU LAMA GLISANTA

cu lama din otel calit

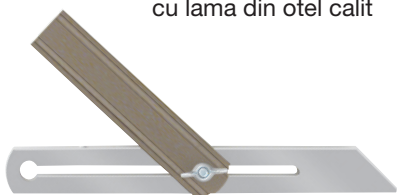

RG	Pret brut	Art. Nr.	Dimensiuni / mm
30		5534-011	250

0243-... ECHER DE CENTRARE

slefuit fin, cu gradare milimetrica, cromat de aceea nu are efect de orbire

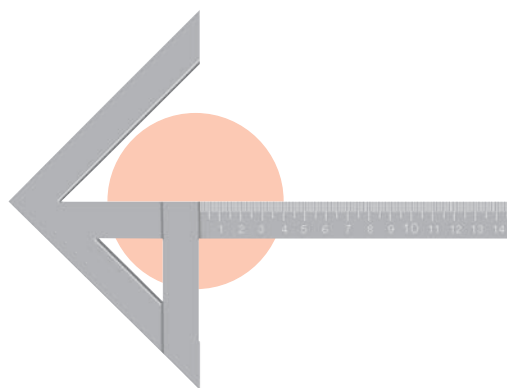

Utilizare: pentru trasarea centrului pe discuri rotunde sau axuri, si ca echer cu unghi de 45 de grade

RG	Pret brut	Art. Nr.	Dim ./mm	Pret brut	Art. Nr.	Dim./mm
2		0243-019	150 x 130		0243-035	250 x 160
		0243-027	200 x 150		0243-043	400 x 250

0241-... RAPORTOR GRADAT

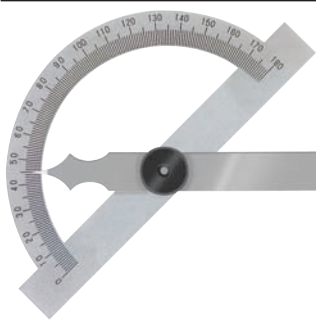

cu scala cromata, cu raportor deschis, din otel special, cu surub de prindere,

citire 1°, scala 0° - 180°, cromat, opac

RG	Pret brut	Art. Nr.	Ø/mm raportor	Lungimea sinelor/mm
2		0241-016	80	120
		0241-024	120	150
		0241-032	150	200
		0241-041	200	300

5535-... RAPORTOR MARE GRADAT

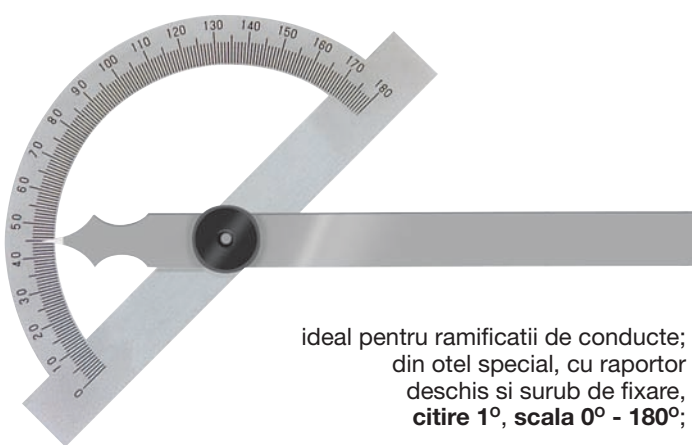

ideal pentru ramificatii de conducte; din otel special, cu raportor deschis si surub de fixare, **citire 1°, scala 0° - 180°;**

RG	Pret brut	Art. Nr.	Ø/mm raportor	Lungimea sinelor/mm
2		5535-018	300	800
		5535-026	400	1000

0242-... RAPORTOR GRADAT

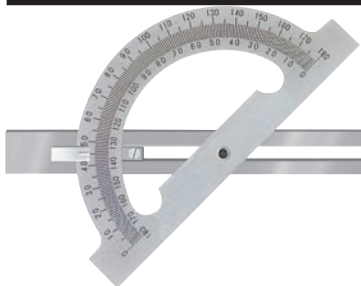

din otel special, **citire 1°, scala dubla 10° - 170°**

cu scala cromata, raportor deschis, sina mobila si surub de fixare;

RG	Pret brut	Art. Nr.	Ø/mm raportor	Lungimea sinelor/mm
2		0242-012	120	300
		0242-021	150	400
		0242-039	200	500

5584-... RAPORTOR UNIVERSAL »MAXIMA«

Utilizare: raportor universal, unghi de 45 de grade precum si pentru controlul pieselor

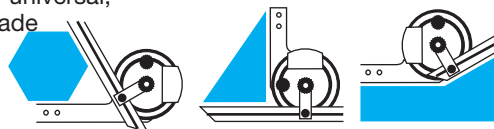

din otel **inoxidabil**, scala este cromata; divizare: 4 ori 90°, vernier de citire 5 minute unghiulare, cu sina mobila de **300 mm**, unghi suplimentar si lupa de citire; in caseta

Unghi suplimentar

300 mm sina



citire 5' pe vernier

RG	Pret brut	Art. Nr.	Executie
2		5584-019	Raportor universal complet cu lupa
		5584-051	idem. in plus cu Certificat de verificare conform ISO 9000

din otel inoxidabil, comparator-scala circulara 4 ori 90°, citire 5 minute unghiulare, cu sine mobile **150, 200 si 300 mm** si unghi suplimentar, in caseta

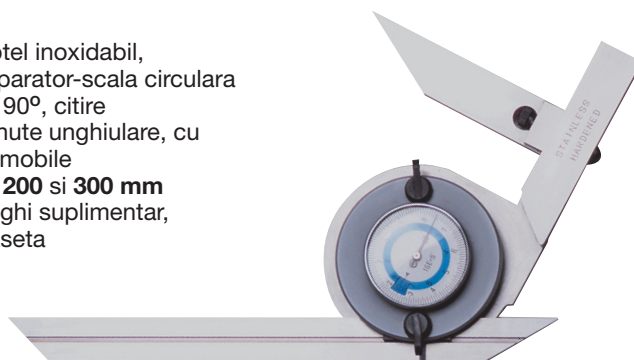

RG	Pret brut	Art. Nr.	Executie
2		5584-060	Raportor cu comparator universal cu Certificat de verificare conform ISO 9000

0208-... RAPORTOR GRADAT MAGNETIC



din plastic, cu opritor; suprafata dreapta de masura cu **magnet permanent** si **suprafata prismatica de masura** pentru tevi; cu gauri pentru fixarea pe suprafete-NE

RG	Pret brut	Art. Nr.	Executie
2		0208-019	cu scala (4 ori 90°) 100 mm Ø, citire 1°, cu magnet permanent si suprafata prismatica de masura

Calibre limitative netede pentru gauri si calibre potcoava, inele de reglare si calibre pentru filet livrabile in termen scurt la cerere!!

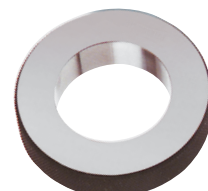
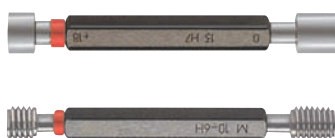

5538-... RAPORTOR UNGHI BURGHIE

cu unghi reglabil
si reglaj pentru
pozitionarea si masurarea
de unghiuri **30 - 160°**

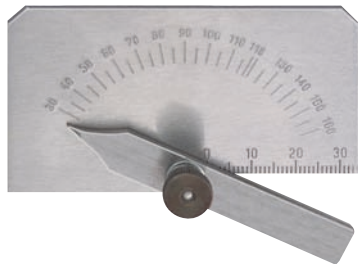

RG	Pret brut	Art. Nr.	Marimea placii de masurat / mm
2		5538-017	80 x 45

0258-... LERA ASCUTIRE BURGHIE



pentru burghie spirala
cu unghi de 118°

RG	Pret brut	Art. Nr.	unghi de margine
2		0258-016	118°

0259-.../0260-.../0261-... LERE- CUTITE FILETARE

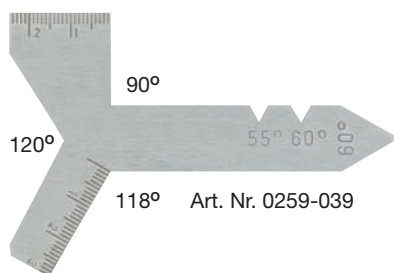

Art. Nr. 0259-039



Art. Nr. 0259-012



Art. Nr. 0259-021



Art. Nr. 0261-017



Art. Nr. 0260-011

RG	Pret brut	Art. Nr.	filet
2		0259-012	metric 60°
		0259-021	Whitworth 55°
		0259-039	Lera combinatie
		0260-011	Lera universal
		0261-017	Lera trapez 2-12 mm

0262-... LERE PENTRU FILETE



RG	Pret brut	Art. Nr.	Filet	Pret brut	Art. Nr.	Filet
2		0262-013	metric 60°		0262-030	metric +
		0262-021	Whitworth 55°			Whitworth

0204-... LERA SANFREN SUDURA

Executie speciala din otel **inoxidabil**
cu divizare a masurii

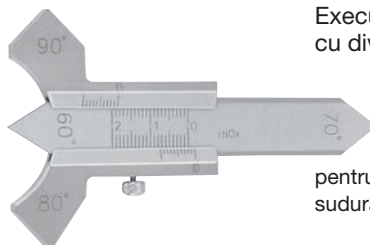

pentru masurarea de cordoane de
sudura platie si unghiulare

RG	Pret brut	Art. Nr.	Executie
2		0204-013	Unghi : 60°, 70°, 80°, 90° Precizie: 1/10 mm

5504-... LERA CORDON SUDURA

suport pe o singura parte
= nu sunt posibile
greseli de masurare;
in husa de piele



RG	Pret brut	Art. Nr.	Executie
2		5504-015	Unghi: 60°, 70°, 80°, 90° Precizie: 1/10 mm

5503-... LERE PENTRU SANFREN

polisat fin



RG	Pret brut	Art. Nr.	domeniu in mm
2		5503-019	3 - 12

0263-... LERE PENTRU RAZE

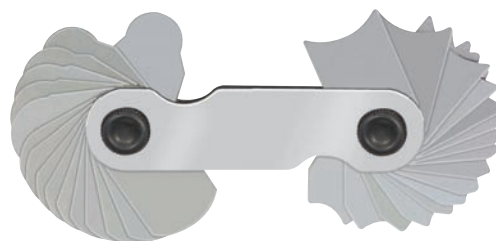

RG	Pret brut	Art. Nr.	pentru gravuri in mm	Pret brut	Art.Nr.	pentru raze in mm
2		0263-010	1,0 - 7		0263-036	15,5 - 25
		0263-028	7,5 - 15			

0264-... SET-LERE SPIONI DIN OTEL

Lungimea lamei 100 mm



Art. Nr. 0264-067 **din alama:** inoxidabil, antimagnetic

RG	Pret brut	Art. Nr.	Numarul lamelor	Dom. de masurare in mm	Executie
2		0264-016	8 lame:	0,05-0,5	din otel
		0264-024	13 lama:	0,05-1,0	
		0264-032	20 lama:	0,05-1,0	
		0264-041	20 lama:	masa de tol	
		0264-067	19 Lama:	0,1-1,0	din alama

0264-... LAME DE SCHIMB - LERE SPIONI

Lungimea lamei 100 mm, lama individuala

RG	Pret brut	Art. Nr.	Dim./mm	Pret brut	Art. Nr.	Dim./mm
2		0264-075	0,05		0264-172	0,55
		0264-083	0,10		0264-181	0,60
		0264-091	0,15		0264-199	0,65
		0264-105	0,20		0264-202	0,70
		0264-113	0,25		0264-211	0,75
		0264-121	0,30		0264-229	0,80
		0264-130	0,35		0264-237	0,85
		0264-148	0,40		0264-245	0,90
		0264-156	0,45		0264-253	0,95
		0264-164	0,50		0264-261	1,00

0266-... SET LERE SPIONI, LUNGI

pe inel, latimea lamei 10 mm



RG	Pret brut	Art. Nr.	Lg. lamei in mm	Domeniu de masurare in mm	Nr. de lame
2		0266-019	200	0,05 - 0,5	8
		0266-027	300		
		0266-035	500		
		0266-043	200	0,05 - 1,0	13
		0266-051	300		
		0266-060	500		
		0266-078	200	0,05 - 1,0	20
		0266-086	300		
		0266-094	500		

0265-... LERE SPIONI TIP BANDA



inoxidabil, 50 mm latime, in cutie

13 mm latime, in doza

RG	Dim. mm	Executie	Pret brut	Art. Nr.	Executie	Pret brut	Art. Nr.
2	0,010			0265-306			0265-241
	0,020			0265-314			0265-012
	0,025			0265-322			
	0,030			0265-331			0265-021
	0,040			0265-349			0265-039
	0,050			0265-357			0265-047
	0,060			0265-365			0265-250
	0,070			0265-373			0265-268
	0,075			0265-381			
	0,080			0265-390			0265-276
	0,090			0265-403			0265-284
	0,100			0265-411			0265-055
	0,120	inoxidabil		0265-420			
	0,150			0265-438			0265-063
	0,180	2,5 m		0265-446		5,0 m	
	0,200	lungime		0265-454		lungime	0265-071
	0,220			0265-462			
	0,250	50 mm		0265-471		13 mm	0265-080
	0,300	latime		0265-489		latime	0265-098
	0,350			0265-497			0265-101
	0,400	in cutie		0265-501		in doza	0265-110
	0,450			0265-519			0265-128
	0,500			0265-527			0265-136
	0,550						0265-144
	0,600						0265-152
	0,650						0265-161
	0,700						0265-179
	0,750						0265-187
	0,800						0265-195
	0,850						0265-209
	0,900						0265-217
	0,950						0265-225
1,000						0265-233	

5536-... LERE-CUTIT DE STRUNG

cu indicatii potrivite pentru unghiul de taiere pentru diferite materiale



Art. Nr. 5536-022

Art. Nr. 5536-014

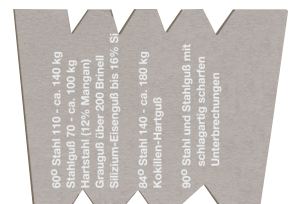

RG	Pret brut	Art. Nr.	Executie pentru	Pret brut	Art. Nr.	Executie pentru
2		5536-014	HSS-Otel		5536-022	HM-otel

0296-... SUPORT LERE SPIONI

pentru utilizare cu banda de lera spioni



RG	Pret brut	Art. Nr.	lungime / mm
2		0296-015	135

0268-... CALIBRU DE INTERIOR-MILIMETRIC (CALIBRU PENTRU GAURI)

Executie de precizie, calit si slefuit fin

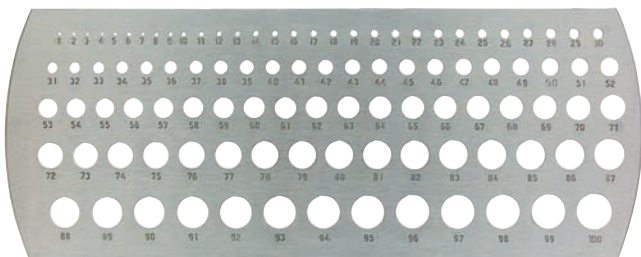

RG	Pret brut	Art. Nr.	Domeniu de masurare / mm	
2		0268-011	0,1 - 10 mm	1/10 mm ascendent

0267-... CALIBRU PENTRU JICLOARE

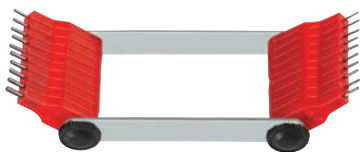

RG	Pret brut	Art. Nr.	Nr. de stifturi	Domeniu de masurare / mm
2		0267-015	20	0,45 - 1,5
		0267-023	16	1,50 - 3,0

5537-... CALIBRU PT. DIUZE



cu varf de control, conic 1:10
cu citire directa 1/10 mm,
cu citire de precizie 1/100 mm

RG	Pret brut	Art. Nr.	Dom de masurare in mm	Pret brut	Art. Nr.	Dom de masurare in mm
2		5537-011	0 - 3,0		5537-029	0 - 5,0

0280-... RIGLA PENTRU FILETE

din PVC-de masurat, scala de culoare negru inchis, pentru filet de teava metric, Withworth si filet pentru gaz

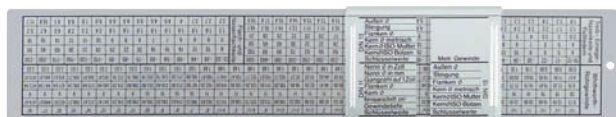

RG	Pret brut	Art. Nr.	Denumire
2		0280-011	DIN filet suber

5540-... »SABLON PENTRU FILETE«

I furnizeaza toate informatiile necesare pentru determinarea unui filet cu terminologie conform normelor: deasemenea distanta Ø dintre gaurile de sonda

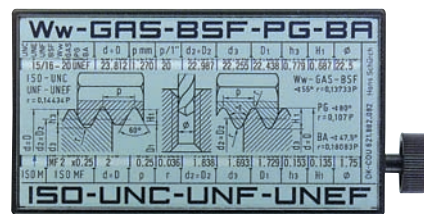

I contine toate filetele importante si normate, utilizate in industrie in tara si in strainatate

RG	Pret brut	Art.Nr.	Denumire	
2		5540-011	Sablón filete	
		Denumire filet	Domeniu	Cantitate
		ISO metric	M 1 - M 68	40
		ISO metric fin	MF 1 x 0,2 - MF 100 x 6	171
		UNC filet standard americ.	1-64 UNC - 4-4 UNC	33
		UNF filet fin americ.	0-80 UNF - 1 1/2-12 UNF	24
		UNEF filet fin americ.	12-32 UNEF - 1 11/16-18 UNEF	25
		Ww (BSw) filet Whitworth engl.	Ww 1/16" - Ww 6"	39
		BSF filet fin- Ww engl.	BSF 3/16" - BSF 4 1/4"	31
		GAS filet de teava engl.	G 1/8" - G 6" (G=R)	26
		BA filet mic engl.	O BA - 14 BA	15
		PG tub blindat de otel	PG 7 - PG 48	10

5541-... »SABLON DE TOLERANTE«

cuprinde lista completa cu tolerantele-ISO, utilizate in tara si in strainatate precum si peste 6400 valori de toleranta;



carcasa de plastic inchis pe toate partile

RG	Pret brut	Art.Nr.	Denumire
2		5541-018	sablón de toleranta

5539-... »CONVERTOR TOL - MILIMETRI«

I inlocuieste toate tabelele de la recalculările cm/tol



I se exclude citirile gresite, nu poate livra rezultate gresite

RG	Pret brut	Art.Nr.	Denumire		
2		5539-013	convertor tol-milimetri		
		Domeniu	Recalculare in	Pozitii dupa virgula	
		Tol 0,001 - 1	milimetru	3,4	
		Tol 1 - 999	milimetru	1	
		Tol 1/2, 1/4, 3/4, ... 63/64	milimetru	4	
		Milimetru 0,001 - 1	Tol	6	
		Milimetru 1 - 999	Tol	3, 4, 5	
		Milimetru 1000 - 9900	Tol	3, 4,	
		Milimetru 1/2, 1/3, 1/4, ... 1/99	Tol	6	

5568-.../0184-... TUROMETRU DIGITAL COMBINAT »DIGITOUR-COMBI«

cu preluare a valorilor de masurat **optica + mecanica**, masurare fara nici o greseala, afisaj-LCD mare 5-pozitii, functie de memorare incorporata, pe baza de cuart

preluare a val. de mas. mec.: masurarea nr. de rotatii pana la 20.000 rot./min.

viteza periferica: pana la 2.000 m pe minut

preluare a val. de masura optice: **masurare fara atingere** a rotatiilor pana la 100.000 Rot/min., si pentru locuri greu **accesibile**

RG	Pret brut	Art. Nr.	Funcții de masurare	Nr. de rotatii in Rot/min.	Viteza periferica in m/min.
		5568-013	mecanica	0,5 - 20.000	0,05 - 2.000
			optica	5,0 - 100.000	—
2		0184-021 0184-039 0184-055	Varf palpator de schimb Coadă de prindere de schimb Roata etalon de rezerva (viteza de rotatie)		

0184-... » TUROMETRU DIGITAL CU VARF CONTACT

cu **preluare a valorilor de masura mecanica**, masurari fara greseli a numarului de rotatii si a vitezei periferice, afisaj-LCD mare cu 5-pozitii, functie de memorare incorporata, inclinat se poate citi bine

RG	Pret brut	Art. Nr.	Nr. de rotatii in Rot/min.	Viteza periferica in m/min.	Precizie in Rot/min.
2		0184-012	0,5 - 10.000	0,05 - 999,9	1
		0184-021 0184-039 0184-055 0184-047	Varf palpator de schimb Coadă de prindere de schimb Roata de masurare de schimb (viteza de rotatie) capat ascutit de rezerva (pentru max. 10 mm Ø)		

0185-... »TUROMETRU DIGITAL OPTIC

cu preluare a valorilor de masura optica pentru masurare **fara atingere**, ideal pentru locuri greu accesibile; masurari ale rotatiilor fara greseli, afisaj-LCD mare 5-pozitii, functie de memorare incorporata, distanta de lucru 5 - 150 mm

RG	Pret brut	Art. Nr.	Domeniu de masurare in Rot/min.	Precizie in Rot/min.
2		0185-019	5 - 100.000	1
		0185-027	Benzi de reflectie 600 x 15 mm, pt. taierea urmelor de reflectie	

5565-... STROBOSCOP DIGITAL

Executie: aparat industrial robust, constructie compacta, cu citire digitala (cifre), tub de xenon extra luminos, cu cuart;

Utilizare: pentru masurarea optica a turatiilor si observarea partilor mobile (ridicari si oscilatii);

RG	Pret brut	Art.Nr.	Tensiune	Blituri / min.	Domenii Rot/min.
35		5565-014	220 V	100 - 10.000	100 - 1.000 1.000 - 10.000

Preluare a valorii de masura optica
5 - 100.000 rot/min.



Preluare a valorii de masura mecanica 0,5 - 20.000 rot/min.



preluare a valorilor de masura mecanica
0,5 - 10.000 Rot/min.



preluare a valorilor de masura optica 5 - 100.000

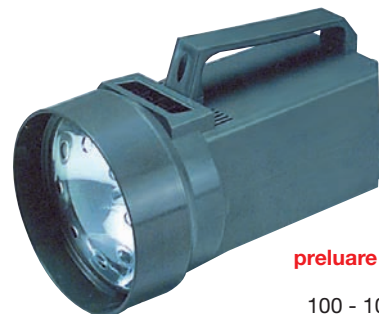

preluare a valorilor de masura optica
100 - 10.000 Rot/min.

Art. Nr. 0278-017

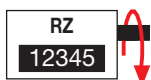

Art. Nr. 0278-025

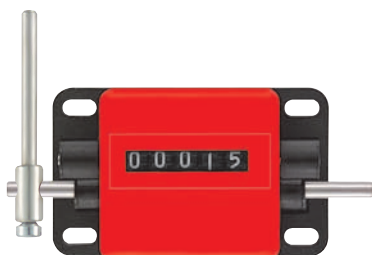

Art. Nr. 0278-033



Art. Nr. 0277-011



Art. Nr. 0289-019



Art. Nr. 0289-027



Art. Nr. 0289-035



Art. Nr. 0289-043



La alegerea si comanda

de contoare mecanice va rugam sa aveti in atentie:
Parte de actionare = dreapta (D) sau stanga (S), vezi desenul simbol



Partea de actionare **dreapta**, rotind **catre** utilizator

Partea de actionare **stanga**, rotind **catre** utilizator

Partea de actionare **dreapta**, rotind in partea opusa utilizatorului

Partea de actionare **stanga**, rotind in partea opusa utilizatorului

0278-... CONTOR

in carcasa stabila, contor cu 5 si 6 pozitii, inaltimea cifrelor 4,5 mm, cu pozitionare pe zero; directia de rotire: **catre utilizator**;

pentru numararea bucatilor la stante, foarfece si prese

RG	Pret brut	Art. Nr.	max. ridicare/min.	Partea de actionare	Denumire	Contor
2		0278-017	cca. 500	dreapta	RZ	5-pozitii
		0278-025	cca. 200	dreapta + stanga etans	LZ + RZ	5-pozitii
		0278-033	ca. 500	dreapta + stanga	LZ + RZ	6-pozitii

0277-... CONTOR DE ROTATIE

in carcasa stabila, contor cu 6 pozitii, inaltimea cifrelor 4,5mm cu pozitionare pe zero, max. turatie 1500 Rot/min.; directia de rotire: partea **opusa utilizatorului**;

RG	Pret brut	Art. Nr.	max. Rot/min.	Partea de actionare	Denumire	Contor
2		0277-011	cca. 1500	dreapta + stanga	.LW + RW	6-pozitii

0289-... CONTOR METRIC

in carcasa stabila, contor 4 pozitii + pozitie decimale, inaltimea cifrelor 4,5 mm, cu pozitionare pe zero, pentru turatie max.1500 Rot/min., fara roata de masurare; directia de rotire: **partea opusa utilizatorului**

RG	Pret brut	Art. Nr.	max. ridicare/min.	Partea de actionare	Denumire	Contor
2		0289-019	ca. 1500	dreapta + stanga	LW + RW	4-pozitii
	rota de masurat pentru contor					
		0289-027 0289-035 0289-043			cu margine curbata drept cu garnitura de cauciuc	

0279-... TUROMETRU MECANIC

contor cu 4-pozitii, inaltimea cifrelor 4,5mm, cu pozitionare pe zero
I aduna in ambele sensuri de rotatie I pana la 6000 Rot/min.

Utilizare: pentru masurarea turatiilor in legatura cu un **cronometru** (de ex. Art. Nr. 0290-050, 0290-076 sau 0187-011, vezi paginile urmatoare)

RG	Pret brut	Art. Nr.	Denumire
2		0279-013	turometru mecanic, in husa

0290-... CRONOMETRE INDUSTRIALE DE PRECIZIE

protejate impotriva prafului si a apei, cu carcasa-ABS si mecanism de precizie cu arcuri incasabile

RG	Pret brut	Art. Nr.	Model	Citire
2		0290-050	cronom. de coroana	1/10 secunda
		0290-076	cronometru aditional	1 / 100 minute si 1/5 secunde



Art. Nr. 0290-050



Art. Nr. 0290-076

0187-... CRONOMETRU DE LITIU+ CRONOGRAF

carcasa de plastic protejata impotriva apei si a prafului, curele de prindere; 4 memorii de stopare - 1/100 sec. - 10 ore, alarma, Timer, timp, zi, luna; complet cu baterie de lunga durata din litiu (pentru 3 ani)

RG	Pret brut	Art. Nr.	Executie
2		0187-011	complet cu Litiu-cu baterie de lunga durata- (pentru 3 ani)



0135-... »PEAK« LUPA DE MASURAT-UNIVERSALA

pentru masurarea de raze, unghiuri, diametre, pasurile filetului cu 13 scale de masurare diferite; fara scala de masurare, in husa

RG	Pret brut	Art. Nr.	Denumire
2		0135-011	lupa de masurat »PEAK« fara scala
	Scale de masurat pentru » P E A K « lupa de masurat		
		0135-046	Scala de masurat standard
		0135-054	Nr. 1 Scala universală
		0135-062	Nr. 2 Scala universală
		0135-071	Nr. 3 Scala de masurat-grosime
		0135-089	Nr. 4 Scala universală
		0135-097	Nr. 5 Scala universală
		0135-101	Nr. 6 Scala universală
		0135-119	Nr. 7 Scala universală
		0135-127	Nr. 8 1/10 mm -scala
		0135-135	Nr. 9 Scala de unghi si de diametru
		0135-143	Nr. 10 Scala-filet, metric
	0135-151	Nr. 11 Scala-filet, tol	
	0135-160	Nr. 12 Scala universală	



Marire:
de 10-ori

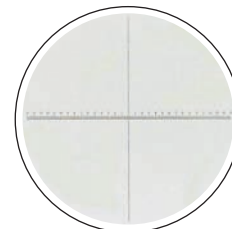

Scala-Standard,
Domeniu de masurare 20 mm
(10 mm stanga, 10 mm dreapta),
1/10 mm si unghiul drept
Art. Nr. 0135-046

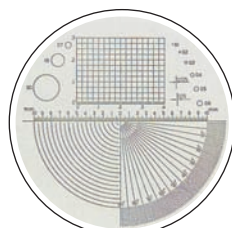

Nr. 1:
Scala universală
Art. Nr. 0135-054

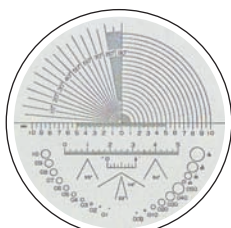

Nr. 2:
Scala universală
Art. Nr. 0135-062

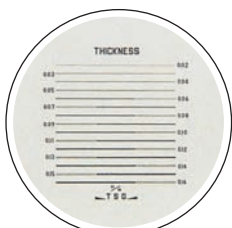

Nr. 3:
Scala de masurat grosime
Art. Nr. 0135-071

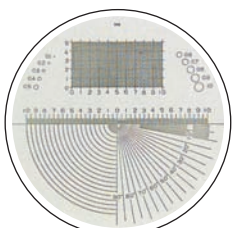

Nr. 4:
Scala universală
Art. Nr. 0135-089

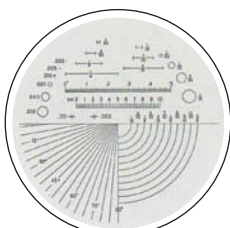

Nr. 5:
Scala universală
Art. Nr. 0135-097

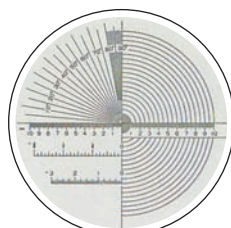

Nr. 6:
Scala universală
Art. Nr. 0135-101

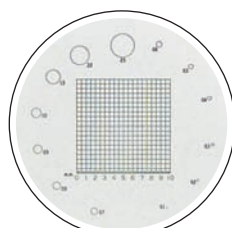

Nr. 7:
Scala universală
Art. Nr. 0135-119

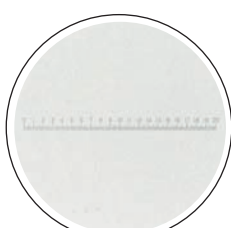

Nr. 8:
1/10 mm Scala
Art. Nr. 0135-127



Nr. 9: **Scala de unghi si diametru**
Art. Nr. 0135-135

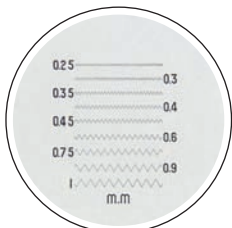

Nr. 10: **Scala-filet, metric**
Art. Nr. 0135-143

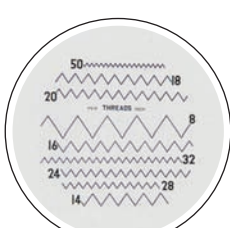

Nr. 11: **Scala-filet, tol**
Art. Nr. 0135-151

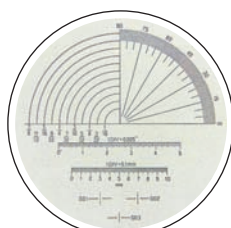

Nr. 12:
Scala universală
Art. Nr. 0135-160

Marire: de 10-ori



Marire: de 10-ori



Marire:
de 3- sau 6-ori



Art. 0197-025

Marire:
de 30-ori

Executie-Zoom
Art. 0197-033

Marire:
de 60 pana la 100-ori



Marire: de 1,8 + 2,3 + 3,7 + 4,8-ori

0186-... »LUPA CU ILUMINARE „PEAK“

Executie: compacta si robusta, **maner de metal** cu carcasa lupei rotitoare si toarta de prindere care se pliaza, sticla lupei protejata, marire de **10-ori**, lumina buna, functioneaza cu baterii

Utilizare: **universal** in orice activitate, **mariri clare** chiar si in conditii proaste de iluminare

RG	Pret brut	Art. Nr.	Marire	Executie
2		0186-015	10 x	pentru 2 Baterii UM 2 1,5 V

5542-... LUPA PLIANTA

cu marire de 10-ori, cu carcasa din otel **inoxidabil**

RG	Pret brut	Art.Nr.	Denumire
2		5542-014	Lupa - plianta

5585-... LUPA STABILA »CLASSIC«

din plastic incasabil

RG	Pret brut	Art.Nr.	Ø Lupa mm	Marire
2		5585-015	50	3 x
		5585-023	50	6 x

0197-... MICROSCOPE DE VERIFICARE CU ILUMINARE

Executie: mic si compact, iluminare buna, reglare precisa prin inel de rotatie; in husa

Utilizare: **universal** in orice activitate, **mariri clare** chiar si in conditii proaste de iluminare

RG	Pret brut	Art. Nr.	Marire	Executie
2		0197-025	30 x	pentru 2 buc. baterii Mignon AA 1,5 V
		0197-033	60 x bis 100 x	Executie-Zoom , marire fara trepte de 60 pana la 100-ori, bec mobil pentru iluminare optima; pentru 2 buc. baterii Mignon AA 1,5 V
		0197-050	Lampa de rezerva pt. Art. Nr. 0197-025 si - 033	

0198-... LUPA PENTRU CAP

camp vizual luminos tridimensional, foarte usoara, banda pentru cap se regleaza repede, se potriveste chiar si celor ce poarta ochelari

RG	Pret brut	Art.Nr.	Executie	Marire
2		0198-021	2 lentile fine + Extralupa	1,8 + 2,3 + 3,7 + 4,8 x

5544-... LUPA STABILA

marire de 3-ori, (8 dioptrii) cu suport flexibil (300 mm)

RG	Pret brut	Art.Nr.	Ø Lupa mm	Ø Talpa de sustinere - mm
2		5544-017	75	120

Marire: de 3-ori



Marire: de 2,5-ori

5556-.. STATIV CU LUPA PENTRU LIPIT

cu marire de 2,5-ori (6 dioptrii), picior greu, stabil cu 2 cleme tip crocodil, reglabil in diferite directii;

Utilizare: pentru cele mai mici si fine lucrari de lipire in domeniul electronic si de construire a machetelor

RG	Pret brut	Art.Nr.	Ø Lupa mm
2		5556-015	63

5545-.../5587-.../2319-... LUPA STABILA »OPTIC« CU LUMINA RECE, 230 V

Executie: din cea mai buna sticla optica lupa-Aplanant slefuita cu marire de 2-ori pentru lucrari indelungate care sa nu afecteze vederea (4 dioptrii, Ø 120 mm, distanta de lucru cca. 150 mm);

iluminare optima prin lampa circulara cu lumina rece 22 W, butonul de pornire montat in bratul mobil, comutator, izolat pentru protectie, cablu de 1,5 m cu stecar;

3 brate mobile extra stabile, descarcare cca. 870 mm

Utilizare: pentru prelucrarea de obiecte foarte mici si cu multe detalii ca de ex. **piese electronice**

RG	Pret brut	Art. Nr.	Executie
99		5545-102	»Optic« Lupa stabila- cu lumina rece (fara picior de fixare – va rugam sa-l comandati)
		5545-111	Suplimentar lupa de prindere , 4 dioptrii (4 + 4 = 8 dioptrii)
100		5587-051	Suplimentar lampa circulara economica, 22 W



Picioare de fixare (negre) pentru urmatoarele modele

Art. Nr. 2319-101, 2319-110, 2319-128, 2336-057 si 5545-102

clema de masa,
0 - 65 mm
Art. 2319-136
pret brut
RG 99



picior de masa
Art. 2319-144
pret brut
RG 99

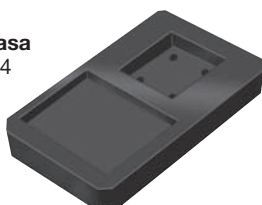

coltar pentru perete
Art. 2319-152
pret brut
RG 99



picior magnetic rotund
Art. 2319-161
pret brut
RG 99



5567-... LUXMETRU »DIGI-LUX«

Executie: aparat industrial robust, constructie compacta; cu memorare a valorii masurate si a valorii maxime precum si inchidere automata; in geanta

Utilizare: masoara repede cantitatea de lumina optima in orice loc de munca

complet cu baterie 12 V (A 23 sau corespondent)

RG	Pret brut	Art. Nr.	masoara	Domeniu	Descompunere
35		5567-025	Lux (cantitate de lumina)	200 Lux 2.000 Lux 20.000 Lux 50.000 Lux	0,1 Lux 1 Lux 10 Lux 100 Lux



pliat in sus =
lampa de lucru
ce nu face
umbra



reglabil in
toate
partile

3 dioptrii

3 dioptrii



In 2 marimi



reflector de lampa
montabil
pentru utilizare
manuala

lentila de marire puternica

Mariri:
de 2 + 4-ori

Marire:
de 2 + 4-ori sau de 2,5 + 5-ori

5588-.../5587-... LAMPA DE BIROU CU LUPA »KOMBI« 230 V

Executie: 22 W lampa circulara economica (= cca. 80 W), Ø 200 mm; lupa, **3 dioptrii** (marirea este in functie de distanta de lucru, regula empirica este: numarul dioptriilor impartit la 4, rezultatul plus 1), Ø 125 mm; cu cablu 1,8 m si stecar

Avantaje: | Lupa se regleaza in toate partile

RG	Pret brut	Art. Nr.	Lupa	Executie
2		5588-014	3 dioptrii	22 (80) W, Ø lampa 125 mm
100		5587-051	Suplimentar lampa circulara economica, 22 W, Ø 200 mm	

5587-... LUPA CU LUMINA RECE SI LAMPA DE BIROU, 230 V »DUPLO/GRAND-DUPLO«

Executie: tuburi circulare economice ideale, nu fac umbra si lupe **3 dioptrii**; cu cca. 2 m cablu, stecar si clema de masa (potrivit pana la cca. 55 mm taria placii)

Utilizare: o usurare enorma la prelucrarea si verificarea pieselor mici; ideal pentru mecanica fina, electronica; ideal si ca lampa de birou universala;

RG	Pret brut	Art. Nr.	Executie
2		5587-018	»Duplo« cu tuburi circulare economice 22 W, Ø 200 mm si Ø lampa 125 mm
100		5587-034	In special ieftin in set: 3 buc. »Duplo« lupa cu lumina rece si lampi de birou
		5587-051	Suplimentar lampa circulara economica, 22 W, Ø 200 mm
2		5587-069	»Grand-Duplo« cu tuburi circulare economice 30 W si Ø lampa 150 mm
100		5587-077	Suplimentar lampa circulara economica, 30 W

5576-.../0197-... LUPE ILUMINATE DE LUCRU SI DE CONTROL

Executie: fara aschiere, lentila de marire puternica, compacta, usor manevrabila si mica, functioneaza cu baterii

Utilizare: universal in orice activitate – mariri clare chiar si in conditii proaste de iluminare

RG	Pret brut	Art. Nr.	Marire	Executie
2		5576-032	2 x + 4 x	Lupa-lampa-dreptunghica, 50 x 100 mm, reflector de lampa montabil pentru utilizarea manuala; pentru 2 buc. baterii Mignon AA 1,5 V
		5576-016	2,5 x + 5 x	Lupa-lampa-circulara, 50 mm Ø; pentru 2 buc. baterii Mignon AA 1,5 V
		5576-024	2 x + 4 x	Lupa-lampa-circulara, 90 mm Ø; pentru 2 buc. baterii Mignon AA 1,5 V
		0197-050	Lampa de rezerva pentru Art. Nr. 5576-016 si -024	

Ideal la toate lucrarile de prelucrare a suprafetelor!



5598-.. RUGOZIMETRU

27 sabioane de comparare inoxidabile, a cate 20 x 12 mm, in husa de piele

Utilizare: pentru fixarea si verificarea calitatii suprafetelor pieselor prelucrate prin aschiere, strunjire, frezare, prin simpla comparare vizuala si palpabila (verificare cu degetul a defectiunii);

RG	Pret brut	Art.Nr.	Executie
100		5598-052	pentru comparare vizuala si palpabila Ra/µm 0,05 - 12,5 (ISO-clasa de duritate N 2 - N 10)

0281-... APARAT PENTRU DETERMINAREA DURITATII »POLDI« (Brinell)

aparatus pt. determinarea duritatii pt. toate materialele rezistente de la 35 - 220 kg/mm², in caseta

RG	Pret brut	Art. Nr.	Executie
2		0281-018	complet cu bara de comparare si lupa de citire
		0281-026	bara de comparare de rezerva

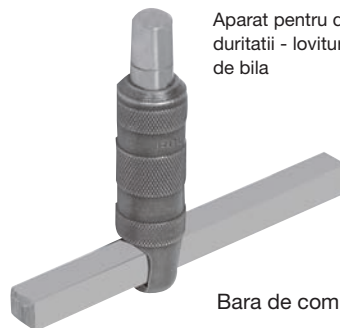

Aparat pentru determinarea duritatii - lovitura in forma de bila



Lupa de citire

Bara de comparare

0281-... »BRINELL «APARAT PENTRU DETERMINAREA DURITATII de generatie 2, in caseta de lemn

Utilizare:

- 1.) montarea stiftului de forfecare
- 2.) cu un ciocan de 2 kg se loveste stiftul mostra, pana cand acesta se rupe in 3 parti
- 3.) Urma se masoara calitativ cu lupa de verificare si cu tabelul de comparatie

Avantaje:

- I nu sunt erori datorita barelor de comparare imprecise
- I portabil

RG	Pret brut	Art. Nr.	Executie
2		0281-051	complet: aparat de verificat cu maner, lupa de masurat cu tabel de comparare si 50 buc. stifturi de forfecare
		0281-069	500 buc. suplimentare stifturi de forfecare
		0281-077	tija de verificare de rezerva

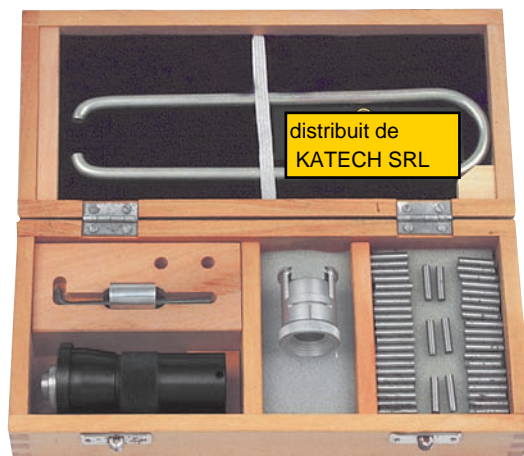

distribuit de KATECH SRL

5562-... »SHORE« APARAT PENTRU DETERMINAREA DURITATII, 0-100 SHORE

cu ac indicator, varf - trunchi de con 35°, citire 1:1;

Utilizare: pentru testarea duritatii de tip Shore A resp. D

RG	Pret brut	Art. Nr.	Executie
2		5562-015	SHORE A pentru cauciuc moale,cauciuc natural, neopren, cu rasina turnata, polyester, PVC-moale etc.
		5562-023	SHORE D pentru plastic tare,elastomer dur, bachelita moale

Shore A cu placa de control si de verificare



5591-... APARATE DE MASURA-GROSIME STRAT

Executie: in forma de pix, potrivit pentru temperaturi normale; in husa de piele

Utilizare: pentru masurarea straturilor nemagnetice ca vopsea, email, acoperiri galvanice, placare cu cositor pe otel

Avantaje:

- I pentru locuri greu accesibile (rotunjiri + colturi)
- I manevrare simpla

RG	Pret brut	Art. Nr.	Executie / Domeniu de masurare
141		5591-015	pentru masuratori orizontale si verticale 0 - 500 µm (metric) / 0,25 - 20 mils (tol)
		5591-023	pentru masuratori verticale 5 - 800 µm (metric)



5591-... APARAT DE MASURA DIGITAL- GROSIME STRATURI

Executie: masoara in toate pozitiile, citire digitala a grosimii straturilor

Utilizare: pentru masurarea straturilor nemagnetice ca vopsea, email, acoperiri galvanice, spoire cu cositor etc.

Avantaje:

- I pentru fier si otel si pentru metale neferoase ca aluminiu, cupru, alama, otel superior, zinc etc.
- I manevrare simpla

RG	Pret brut	Art. Nr.	Executie / Domeniu de masurare
100		5591-031	pentru fier si metale neferoase, 0 - 5000 µm

pentru fier si metale neferoase!



5551-... » MULTIMETRU IP 67

- cu **Autorange** (selectare automata a domeniului de masurare) + alegere manuala a domeniului
- **memorarea valorilor masurate**, tasta maxim/minim, tasta valoare relativa masurata (masoara abaterile de la o valoare de referinta), Tasta MODE
- **prezentare exacta** a valorii masurate: **Cifre luminoase foarte mari, precum si linie analog**
- **inchidere automata**, afisaj baterie

IP 67: impermeabil la praf si apa
(la scufundari temporare)

masoara **tensiunea**

DC: 0,1 mV - 1000 V

AC: 1 mV - 750 V

masoara **curentul** AC/DC: 0,1 μ A 10 A

masoara **rezistenta**: 0,1 Ω - 60 M Ω

masoara **frecventa**: 0,001 Hz - 40 MHz

masoara **capacitatea**: 0,01 nF - 1000 μ F

precum si semnalizator de trecere cu testare diode

masoara **temperatura** cu perla termica, \varnothing 1 mm: -45 pana la +750°C (cu comutare pe F)

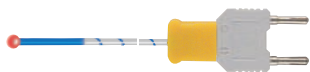

cu suport vertical rabatabil

IP 67: impermeabil la praf si apa

NOU

5551-... MULTIMETRU RS 232

- cu **Autorange** (selectare automata a domeniului de masurare) + selectare manuala a domeniului, **prezentarea clara a valorilor masurate** + cifre luminoase **foarte mari**
- **memorarea datelor masurate**, tasta valoare relativa masurata (masoara abaterile de la valoarea de referinta), **inchidere automata**
- **Display** cu **comanda** pentru racorduri-cabluri masurare, baterie si afisaj temperatura incapere
- **transmitere date prin cablu sau**



Cu interfata RS 232!

masoara **tensiunea**

DC: 0,1 mV - 1000 V

AC: 1 mV - 750 V

masoara **curentul** AC/DC: 0,1 μ A - 20 A

masoara **rezistenta**: 0,1 Ω - 40 M Ω

masoara **frecventa**: 9,99 Hz - 9,99 MHz

masoara **capacitatea**: 10 pF - 100 μ F

precum si semnalizator de trecere si test diode

masoara temperatura cu perla termica, \varnothing 1 mm: -20 pana la +1000°C (cu comutare pe F)

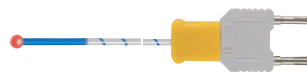

cu suport rabatabil de agatare

NOU

RG	Pret brut	Nr. art.	Model
35		5551-099	Multimetru IP 67 complet cu cablu de masurare, inchizator cu stecher si perla termica in geanta cu cordon (necesita baterii de 9 V)

Funcție	Domeniu	Exactitate	Rezolutie	Supraincarcare
Tensiune egala DC tensiune max. intrare 1000 V DC sau 1000 V AC rms	600 mV 6 V 60 V 600 V 1000 V	$\pm 0,1\% \pm 2 d$ $\pm 0,1\% \pm 2 d$ $\pm 0,1\% \pm 2 d$ $\pm 0,1\% \pm 2 d$ $\pm 0,2\% \pm 2 d$	0,1 mV 1 mV 10 mV 100 mV 1 V	
Tensiune alternativa AC Tensiune max. la intrare 1000 V DC, 1000 V AC rms Domeniu frecventa 50/60 Hz	6V 60 V 600 V 1000 V	$\pm 1,0\% \pm 3 d$ $\pm 1,0\% \pm 3 d$ $\pm 1,0\% \pm 3 d$ $\pm 1,2\% \pm 5 d$	1 mV 10 mV 100 mV 1 V	
Curent continuu DC max. intrare 500 mA, 1000 V 10 A, 1000 V	600 μ A 6000 μ A 60 mA 600 mA 6 A 10 A 20 A*	$\pm 1,0\% \pm 3 d$ $\pm 1,0\% \pm 3 d$ $\pm 1,0\% \pm 3 d$ $\pm 1,0\% \pm 3 d$ $\pm 1,5\% \pm 3 d$ $\pm 1,5\% \pm 3 d$	0,1 μ A 1 μ A 10 μ A 100 μ A 1 mA 10 mA	0,5 A 1000 V 10 A 1000 V sigurante
Curent alternativ AC max. intrare 500 mA, 1000 V 10 A, 1000 V	600 μ A 6000 μ A 60 mA 600 mA 6 A 10 A 20 A*	$\pm 1,5\% \pm 3 d$ $\pm 1,5\% \pm 3 d$ $\pm 1,5\% \pm 3 d$ $\pm 1,5\% \pm 3 d$ $\pm 2,0\% \pm 5 d$ $\pm 2,0\% \pm 5 d$	0,1 μ A 1 μ A 10 μ A 100 μ A 1 mA 10 mA	0,5 A 1000 V 10 A 1000 V sigurante
Rezistenta max. intrare 1000 V AC/DC	600 Ω 6 k Ω 60 k Ω 600 k Ω 6 M Ω 60 MΩ	$\pm 0,3\% \pm 4 d$ $\pm 0,3\% \pm 4 d$ $\pm 0,3\% \pm 4 d$ $\pm 0,3\% \pm 4 d$ $\pm 0,3\% \pm 4 d$ $\pm 0,5\% \pm 20 d$	0,1 Ω 1 Ω 10 Ω 100 Ω 1 k Ω 10 k Ω	
Capacitate max. intrare 1000 V AC/DC	60 nF 600 nF 6 μ F 60 μ F 600 μ F 1000 μ F	$\pm 3,5\% \pm 4 d$ $\pm 3,5\% \pm 4 d$ $\pm 3,5\% \pm 4 d$ $\pm 3,5\% \pm 4 d$ $\pm 3,5\% \pm 4 d$ $\pm 5,0\% \pm 5 d$	0,1 nF 0,1 nF 0,001 μ F 0,01 μ F 0,1 μ F 1 μ F	
Frecventa Sensibilitate min. 0,8 V rms la < = 1 00 kHz su min. 5V rms la > 100 kHz	9,999 Hz 99,99 Hz 999,9 Hz 9,999 kHz 99,99 kHz 999,9 kHz 9,999 MHz	$\pm 0,1\% \pm 1 d$ $\pm 0,1\% \pm 1 d$ $\pm 0,1\% \pm 1 d$ $\pm 0,1\% \pm 1 d$ $\pm 0,1\% \pm 1 d$ $\pm 0,1\% \pm 1 d$ $\pm 0,1\% \pm 1 d$	0,001 Hz 0,01 Hz 0,1 Hz 1 Hz 10 Hz 100 Hz 1 kHz 0,1 MHz	
Temperatura	-45 pana 750°C -50 pana 1382°F	$\pm 3,0\% \pm 5 d$ $\pm 3,0\% \pm 3 d$	1°C 1°F	

RG	Pret brut	Nr. art.	Model
35		5551-102	Multimetru RS 232 complet cu cablu de masurare, cablu de date, Software-CD si perla termica (necesare baterii 9 V)

Funcție	Domeniu	Exactitate	Rezolutie	Supraincarcare
Tensiune egala DC tensiune max. la intrare 1000 V DC sau 750 V AC rms	400 mV 4 V 40 V 400 V 1000 V	$\pm 0,5\% \pm 2 d$ $\pm 1,2\% \pm 2 d$ $\pm 1,2\% \pm 2 d$ $\pm 1,2\% \pm 2 d$ $\pm 1,5\% \pm 2 d$	0,1 mV 1 mV 10 mV 100 mV 1 V	
Tensiune alternativa AC tensiune max. la intrare 1000 V DC sau 750 V AC rms	400 mV 4 V 40 V 400 V 750 V	$\pm 2,0\% \pm 30 d$ $\pm 0,8\% \pm 3 d$ $\pm 0,8\% \pm 3 d$ $\pm 0,8\% \pm 3 d$ $\pm 2,0\% \pm 4 d$	0,1 mV 1 mV 10 mV 100 mV 1 V	
Curent continuu DC max. intrare 400 mA DC/AC rms bzw. 20 A DC/AC rms	400 μ A 4000 μ A 40 mA 400 mA 20 A	$\pm 1,5\% \pm 3 d$ $\pm 1,5\% \pm 3 d$ $\pm 1,5\% \pm 3 d$ $\pm 1,5\% \pm 3 d$ $\pm 2,5\% \pm 5 d$	0,1 μ A 1 μ A 10 μ A 100 μ A 10 mA	0,5 A 600 V 10 A 600 V sigurante
Curent alternativ AC max. intrare 400 mA DC/AC rms bzw. 20 A DC/AC rms	400 μ A 4000 μ A 40 mA 400 mA 20 A	$\pm 1,8\% \pm 5 d$ $\pm 1,8\% \pm 5 d$ $\pm 1,8\% \pm 5 d$ $\pm 1,8\% \pm 5 d$ $\pm 3,0\% \pm 7 d$	0,1 μ A 1 μ A 10 μ A 100 μ A 10 mA	0,5 A 600 V 10 A 600 V sigurante
Rezistenta max. intrare 1000 V AC/DC	400 Ω 4 k Ω 40 k Ω 400 k Ω 4 M Ω 40 MΩ	$\pm 1,2\% \pm 4 d$ $\pm 1,0\% \pm 2 d$ $\pm 1,0\% \pm 2 d$ $\pm 1,0\% \pm 2 d$ $\pm 1,0\% \pm 2 d$ $\pm 2,0\% \pm 3 d$	0,1 Ω 1 Ω 10 Ω 100 Ω 1 k Ω 10 k Ω	500 V DC 500 V AC rms
Capacitate max. intrare 1000 V AC/DC	40 nF 400 nF 4 μ F 40 μ F 100 μF	$\pm 5,0\% \pm 7 d$ $\pm 3,5\% \pm 5 d$ $\pm 3,5\% \pm 5 d$ $\pm 3,5\% \pm 5 d$ $\pm 5,0\% \pm 5 d$	10 pF 0,1 nF 1 nF 10 nF 0,1 μ F	500 V DC 500 V AC rms
Frecventa Sensibilitate min.	9,999 Hz 99,99 Hz 999,9 Hz 9,999 kHz 99,99 kHz 999,9 kHz 9,999 MHz 9,999 MHz	$\pm 1,2\% \pm 5 d$ $\pm 1,2\% \pm 5 d$ $\pm 1,2\% \pm 3 d$ $\pm 1,2\% \pm 3 d$ $\pm 1,2\% \pm 3 d$ $\pm 1,2\% \pm 3 d$ $\pm 1,5\% \pm 4 d$	0,001 Hz 0,01 Hz 0,1 Hz 1 Hz 10 Hz 100 Hz 1 kHz	500 V DC 500 V AC rms
Temperatura	-20 pana la 1000°C -4 pana 1832°F	$\pm 3,0\% \pm 2 d$ $\pm 3,0\% \pm 2 d$	0,1/1°C 0,1/1°F	

Accesorii suplimentare:

Geanta disponibila;
Art. 5551-048, pret brut

RG 35



5551-... MULTIMETRU »DIGI-DO-ALL-2«

- **Autorange** sau alegere manuala a domeniului
- **Cifre cu vizibilitate buna**, luminate= citire mereu **fara eroare**
- **memorarea valorii masurate**, tasta valori de masurare relative, tasta multifunctiuni
- inchidere **automata**, supraveghere baterie
- **deosebit de mic si comod**, cu suport de fixare
- masoara **tensiunea**: pana 600 V AC/DC
- masoara **curentul**: pana 10 A, AC/DC
- masoara **rezistenta**: pana 40 MΩ
- masoara **frecventa**: pana 200 kHz
- masoara **capacitatea**: pana 200 μF

precum si semnalizator de trecere si test diode

5 aparate in 1: masoara pur si simplu tot!

masoara **umiditatea relativa**: 30 - 90%
masoara **zgomotul**: 35 - 100 dB
masoara **lumina**: 0 pana la 4000 Lux
cu **senzori integrati**

masoara **temperatura** cu perla termica, Ø 1 mm : -20 pana+1000°C



5 aparate in 1!

**Siguranta ridicata:
IEC 1010!**

RG	Pret brut	Nr. art.	Model
35		5551-064	Multimetru»Digi-Do All-2« complet cu cabluri de masurare si perla termica disponibil in geanta (necesita baterii de 9V)

Funcție	Domeniu	Exactitate	Rezolutie	Supraincarcare
Tensiune continua DC tensiune max. intrare 600 V DC sau 600 V AC rms impedanta 10 MΩ	400 mV	± 0,7% ± 2 d	0,1 mV	Domeniu 400 mV: 250 V DC sau AC rms
	4 V	± 0,7% ± 2 d	1 mV	
	40 V	± 0,7% ± 2 d	10 mV	
	400 V	± 0,7% ± 2 d	100 mV	
	600 V	± 0,7% ± 2 d	1 V	
Tensiune alternativa AC tensiune max. intrare 600 V DC, 600 V AC rms dom. frecventa 40 - 1000 Hz impedanta 10 MΩ	4 V	± 0,8% ± 3 d	1 mV	Domeniu 4 - 600 V: 600 V DC sau AC rms
	40 V	± 0,8% ± 3 d	10 mV	
	400 V	± 0,8% ± 3 d	100 mV	
	600 V	± 0,8% ± 3 d	1 V	
		± 0,8% ± 3 d	1 V	
Gleichstrom DC max. intrare 400 mA la mA resp. 10 A la 10 A	40 mA	± 1,2% ± 3 d	10 μA	mA-Domeniu: 500 mA/ 250 V
	400 mA	± 1,2% ± 3 d	100 μA	
	10 A	± 2,0% ± 10 d	10 mA	
		± 2,0% ± 10 d	10 mA	
Curent alternativ AC max. intrare 400 mA la mA resp. 10 A la 10 A dom.frecventa 40 - 1000 Hz	40 mA	± 1,5% ± 5 d	10 μA	500 mA/ 250 V
	400 mA	± 1,5% ± 5 d	100 μA	
	10 A	± 3,0% ± 10 d	10 mA	
		± 3,0% ± 10 d	10 mA	
Rezistenta	400 Ω	± 1,2% ± 2 d	0,1 Ω	250 V DC sau 250 V AC rms
	4 kΩ	± 1,2% ± 2 d	1 Ω	
	40 kΩ	± 1,2% ± 2 d	10 Ω	
	400 kΩ	± 1,2% ± 2 d	100 Ω	
	4 MΩ	± 1,2% ± 2 d	1 kΩ	
	40 MΩ	± 2,0% ± 5 d	10 kΩ	
Capacitate	4 nF	± 3,0% ± 3 d	1 pF	250 V DC sau 250 V AC rms
	40 nF	± 3,0% ± 3 d	10 pF	
	400 nF	± 3,0% ± 3 d	0,1 nF	
	4 μF	± 3,0% ± 3 d	1 nF	
	40 μF	± 3,0% ± 3 d	10 nF	
	200 μF	± 3,0% ± 3 d	100 nF	
Frecventa	9,999 Hz	± 2,0% ± 5 d	0,001 Hz	250 V DC sau 250 V AC rms
	99,99 Hz	± 1,5% ± 5 d	0,01 Hz	
	999,9 Hz	± 1,5% ± 5 d	0,1 Hz	
	9,999 kHz	± 1,5% ± 5 d	1 Hz	
	99,99 kHz	± 2,0% ± 5 d	10 Hz	
	199,9 kHz	± 2,0% ± 5 d	100 Hz	
	Impedanta 10 MΩ	± 2,0% ± 5 d	100 Hz	
Temperatura in °C	-20 pana 0°C	± 5,0% ± 8 d	0,1°C	500 mA/ 250 V
	0 pana 20°C	± 3,0% ± 8 d	0,1°C	
	20 pana 400°C	± 2,0% ± 5 d	0,1°C	
	-20 pana 0°C	± 5,0% ± 5 d	1°C	
	0 pana 400°C	± 1,0% ± 3 d	1°C	
	400 pana 1000°C	± 2,0% ± 3 d	1°C	
Umiditate rel. a aerului %	30 pana 90%	± 5,0% 0 - 40°C	0,1%	
Unda (100 - 10000 Hz)	35 pana 100 dB	± 3,5% p. 94 dB	0,1 dB	
Lumina	Lux (4000)	± 5,0%	1 Lux	
	2850°K Temp.cul. x10 Lux	(4000)± 5,0%	10 Lux	

5551-... MULTIMETRU »DIGI-DO-ALL-1«

- **Autorange** (selectare automata a domeniului de masurare)
- **cifre uriașe**, luminate = citire mereu **fara eroare**
- **memorarea valorilor masurate**, tasta mod AC/DC, tasta valori relative pentru masurarea abaterilor de la o valoare de referinta
- inchidere **automata**,
Test stadiu baterie
- cu suport rabatabil de fixare

masoara **tensiune**:
DC pana 1000 V, AC pana 700 V
masoara **curent**: AC/DC pana 20 A

masoara **rezistenta**: pana 40 MΩ
masoara **frecventa**: pana 9,999 MHz
masoara **capacitatea**: pana
100 μF
precum si senzor de trecere
si test diode

NOU! Acum suplimentar:

masoara **temperatura** cu
perla termica, Ø 1 mm: -20
pana+760°C (comutabil pe F)

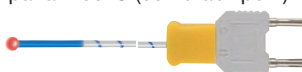

**Favoritul, pana
la 20 Amperi!**
Se citește ideal!



inchidere automata,
cabluri de masurare mereu
bine racordate

RG	Pret brut	Nr. art.	Model
35		5551-081	Multimetru»Digi-Do All-1« complet cu cabluri de masurare si perla termica (necesita baterii de 9 V)

Funcție	Domeniu	Exactitate	Rezolutie	Supraincarcare
Tensiune continua DC tensiune max. intrare 1000 V DC sau 700 V AC rms impedanta 10 MΩ	400 mV	± 0,5% ± 2 d	0,1 mV	Domeniu 400 mV: 250 V DC sau AC rms
	4 V	± 1,2% ± 2 d	1 mV	
	40 V	± 1,2% ± 2 d	10 mV	
	400 V	± 1,2% ± 2 d	100 mV	
	1000 V	± 1,5% ± 2 d	1 V	
Tensiune alternativa AC tensiune max. intrare 1000 V DC, 700 V AC rms Domeniu frecventa 50 - 400 Hz impedanta 10 MΩ	4 V	± 1,2% ± 3 d	1 mV	Domeniu 4 - 600 V: 600 V DC sau AC rms
	40 V	± 1,5% ± 3 d	10 mV	
	400 V	± 1,5% ± 3 d	100 mV	
	700 V	± 2,0% ± 4 d	1 V	
		± 2,0% ± 4 d	1 V	
Curent continuu DC max. intrare 400 mA DC sau 400 mA AC rms la μA/mA resp. 20 A DC sau 20 A AC rms la 4A/20A	400 μA	± 1,0% ± 3 d	0,1 μA	0,5 A / 250 V si 20 A / 250 V siguranta
	4000 μA	± 1,5% ± 3 d	1 μA	
	40 mA	± 1,5% ± 3 d	10 μA	
	400 mA	± 1,5% ± 3 d	100 μA	
	20 A	± 2,5% ± 5 d	1 mA	
Curent alternativ AC max. intrare 400 mA DC sau 400 mA AC rms la μA/mA resp. 20 A DC sau 20 A AC rms la 4A/20A Spat. frecventa 50 - 400 Hz	400 μA	± 1,5% ± 5 d	0,1 μA	0,5 A / 250 V si 20 A / 250 V siguranta
	4000 μA	± 1,8% ± 5 d	1 μA	
	40 mA	± 1,8% ± 5 d	10 μA	
	400 mA	± 1,8% ± 5 d	100 μA	
	20 A	± 3,0% ± 7 d	1 mA	
Rezistenta	400 Ω	± 1,2% ± 4 d	0,1 Ω	250 V DC sau 250 V AC rms
	4 kΩ	± 1,0% ± 2 d	1 Ω	
	40 kΩ	± 1,2% ± 2 d	10 Ω	
	400 kΩ	± 1,2% ± 2 d	100 Ω	
	4 MΩ	± 1,2% ± 2 d	1 kΩ	
	40 MΩ	± 2,0% ± 3 d	10 kΩ	
Capacitate	40 nF	± 5,0% ± 7 d	10 pF	250 V DC sau 250 V AC rms
	400 nF	± 3,0% ± 5 d	0,1 nF	
	4 μF	± 3,0% ± 5 d	1 nF	
	40 μF	± 3,0% ± 5 d	10 nF	
	100 μF	± 5,0% ± 5 d	0,1 μF	
		± 5,0% ± 5 d	0,1 μF	
frecventa Sensibilitate min. 0,5 V rms la <= 1 MHz sau >3 V rms la >1 MHz	9,999 Hz	± 1,5% ± 5 d	0,001 Hz	250 V AC/DC
	99,99 Hz	± 1,5% ± 5 d	0,01 Hz	
	999,9 Hz	± 1,2% ± 3 d	0,1 Hz	
	9,999 kHz	± 1,2% ± 3 d	1 Hz	
	99,99 kHz	± 1,2% ± 3 d	10 Hz	
	999,9 kHz	± 1,2% ± 3 d	100 Hz	
	9,999 MHz	± 1,5% ± 4 d	1 kHz	
Test baterii 9 V , 6 mA	9 V	± 1,0% ± 3 d	10 mV	250 V AC/DC
Temperatura	-20 pana 760°C	± 3,0% ± 3 d	1°C	250 V AC/DC
	-4 pana1400°F	± 3,0% ± 3 d	1°F	

8521-... »TESTER ELECTRONIC DE TENSIUNE

- stabil, rezistent la loviri, etans impotriva prafului si **cu protectie impotriva stropirii cu apa** (IP64), deci si pentru exterior; **verificat - EN 61243-3**
- 12 - 500/750 Volti AC/DC, afisaj nivel bobina mobila
- verificarea polaritatii, verificarea fazelor
- afisaj fara baterie



- masurari corecte, fara **indicarea gresita** a tensiunii reactive, capacitive si inductive

RG	Pret brut	Nr. art.	Executie
35		8521-026	Afisaj LED± 12, 24, 50, 120 Volti ≈ / = Dispozitiv de masurare bobina mobila 230, 400, 500, 750 Volt ≈ / =

2503-... »TESTER TENSIUNE

Tester tensiune, cu afisaj LED, pana la 690 V AC/DC, verificare polaritate, verificare faze cu 1-pol, verificare trecere; cu **luminarea locurilor masurate** si protectie varf de masurare; cu introducere, pentru **1-verificare manuala ideala** (latime doza priza)



Verificat EN 61243-3, CAT IV / 600 V, etans impotriva prafului si **apei** (IP65), deci si pentru exterior

RG	Pret brut	Nr.art.	Model	Domeniu verificare
35		2503-077	UNI 2000	6 - 690 V; necesita 2 baterii AAA

5560-... »TESTER DE TENSIUNE

- masoara **tensiunea**(AC/DC pana la 500 V) + **curent**(DC/AC pana la 300 mA) + **rezistenta** (pana la 30 MΩ) cu selectare **automata** sau **manuala** a domeniului; **semnalizator de trecere**
- memorarea valorilor masurate si salvarea domeniului de masurare ● Citire digitala + sir analog ● inchidere automata



RG	Pret brut	Nr. art.	Model
35		5560-047	Tester de tensiune cu varfuri de verificare si clema-crocodil de fixare (necesita 3 baterii AAA)

Funcție	Domeniu	Exactitate	Rezoluție
Tensiune continua DC tensiune max. intrare 500 V AC/DC impedanta 10 MΩ	300 mV 3 V 30 V 300 V 500 V	± 1,5% ± 5 d ± 1,5% ± 5 d ± 1,0% ± 2 d ± 1,0% ± 2 d ± 1,0% ± 2 d	100 μV 100 μV 100 μV 100 μV 100 μV
Tensiune alternativa AC tensiune max. intrare 500 V AC/DC, Domeniu frecventa 40 - 400 Hz impedanta 10 MΩ	3 V 30 V 300 V 500 V	± 1,5% ± 8 d ± 1,5% ± 8 d ± 1,5% ± 8 d ± 1,5% ± 8 d	1 mV 1 mV 1 mV 1 mV
Curent continuu DC	30 mA 300 mA	± 1,5% ± 3 d ± 1,5% ± 3 d	10 μA 10 μA
Curent alternativ AC	30 mA 300 mA	± 2,0% ± 5 d ± 2,0% ± 5 d	10 μA 10 μA
Rezistenta Protectie intrare 250 V rms	300, 3k, 30k, 300 kΩ 3 MΩ 30 MΩ	± 1,5% ± 5 d ± 2,0% ± 8 d ± 3,0% ± 10 d	0,1 Ω 0,1 Ω 0,1 Ω

5563-... »CLAMPMETRU CURENT CONTINUU-ALTERNATIV

- cu **Autorange** (selectare autom. a domeniului) pentru V si Ω, **prezentarea exacta a valorilor masurate** si cifre **foarte usor vizibile**
- memorarea valorilor masurate, tasta valoare relativa, inchidere **automata**, test stadiu baterie

NOU

masoara **tensiunea** AC/DC:

1 mV - **600 V**

masoara **curentul** AC/DC: 1 mA - **80 A**

masoara **rezistenta**: 400 Ω - 40 MΩ,

masoara **frecventa**: 5 Hz - 10 MHz,

masoara **capacitatea**: 40 nF - 100 μF

precum si semnalizator de trecere

si test diode



pana la Ø 15 mm

Verificat CAT 3!

RG	Pret brut	Nr. art.	Model
35		5563-038	Clampmetru in geanta cu cordon, cu cablu de masurare (necesita 2 baterii AAA)

Funcție	Domeniu	Exactitate	Rezoluție	Supraincarcare
Tensiune continua DC impedanta 7,8 MΩ	0,4 V 4 V 40 V 400 V 600 V	± 1,0% ± 10 d ± 1,0% ± 8 d ± 1,5% ± 10 d ± 1,5% ± 8 d ± 2,0% ± 15 d	0,1 mV 1 mV 10 mV 0,1 V 1 V	600 V DC sau 600 V AC
Tensiune alternativa AC Dom. frecventa 50/60 Hz Impedanta 7,8 MΩ	0,4 V 4 V 40 V 400 V 600 V	± 1,0% ± 5 d ± 2,0% ± 5 d ± 2,0% ± 5 d ± 2,0% ± 5 d ± 2,0% ± 5 d	0,1 mV 1 mV 10 mV 0,1 V 1 V	600 V AC 600 V AC rms
Curent continuu DC	4 A 80 A	± 2,8% ± 10 d ± 3,0% ± 8 d	0,1 A 1 A	max. 120% a domeniilor pentru 60 sec.
Curent alternativ AC Dom. frecventa 50/60 Hz	4 A 80 A	± 3,0% ± 10 d ± 3,0% ± 8 d	0,1 A 1 A	
Rezistenta	400 Ω 4 kΩ 40 kΩ 400 kΩ 4 MΩ 40 MΩ	± 1,0% ± 4 d ± 1,5% ± 2 d ± 1,5% ± 2 d ± 1,5% ± 2 d ± 2,5% ± 3 d ± 3,5% ± 5 d	0,1 Ω 1 Ω 10 Ω 0,1 kΩ 1 kΩ 10 kΩ	
Capacitate	40 nF 400 nF 4 μF 40 μF 100 μF	± 5,0% ± 30 d ± 3,0% ± 5 d ± 3,5% ± 5 d ± 3,5% ± 5 d ± 5,0% ± 5 d	1 pF 10 pF 0,1 nF 1 nF 10 nF	
Frecventa Domeniu masurare 1 - 10 V rms	5 Hz 50 Hz 500 Hz 5 kHz 50 kHz 500 kHz 5 MHz 10 MHz	± 1,5% ± 5 d ± 1,2% ± 2 d	0,01 Hz 0,1 Hz 1 Hz 10 Hz 0,1 kHz 0,1 kHz 0,1 kHz	

5551-... CABLURI DE MASURARE, DE REZERVA

Cablu verificare si varfuri, rosu/negru, 90 cm lungime, pana la 1.200 V, cu stecher de colt



RG	Pret brut	Nr.art.	Denumire
35		5551-056	Cabluri de masurare, de rezerva

5554-... CLAMPMETRU DIGITAL

- Memorarea valorilor masurate si testare stadiu baterie
- cifre mari, luminate = citire fara erori

masoara **tensiunea**:
DC pana la 1000 V, AC pana la 750 V
masoara **curent**: AC pana la **1000 A**
masoara **rezistenta**: pana la 2000 Ω
precum si semnalizator de trecere



NOU! Acum suplimentar:

masoara **temperatura** cu perla termica, Ø 1 mm:
-40 pana +750°C

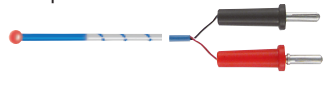

Verificat CAT 2 / CAT 3!

RG	Pret brut	Nr. art.	Model
35		5554-021	»Clampmetru in valiza cu cabluri de masurare si perla termica(necesita baterii 9V)
		5554-039	geanta disponibila, inclusa

Funcție	Domeniu	Exactitate	Rezolutie	Supraincarcare
Tensiune continua DC Impedanta 10 MΩ	1000 V	± 1,0% ± 2 d	1 V	1000 V DC sau 750 V AC rms
Tensiune alternativa AC Spat. frecventa 40 - 400 Hz Impedanta 10 MΩ	750 V	± 1,0% ± 5 d	1 V	
Curent alternativ AC Domeniu frecventa 50 - 60 Hz	20 A 200 A 1000 A	± 2,0% ± 5 d ± 2,0% ± 5 d ± 2,0% ± 7 d	0,01 A 0,1 A 1 A	max. 120% din spatii pentru 60 sec.
Rezistenta	200 Ω 2000 Ω	± 1,0% ± 3 d ± 1,0% ± 3 d	0,1 Ω 1 Ω	
Temperatura	-40 pana 0°C 0 pana 400°C 400 pana 750°C	± 1,0% ± 6 d ± 1,0% ± 3 d ± 1,0% ± 5 d	1°C 1°C 1°C	

5551-... Multimetru »DIGI-POCKET«

- cu **autorange** (selectare automata a domeniului) la toate functiile
- memorarea valorii masurate, inchiderea **automata**

masoara **tensiunea**: pana 600 V, AC/DC
masoara **curent**: pana 400 mA, AC/DC
masoara **rezistenta**: pana 40 MΩ
precum si semnalizator de trecere
si test diode



verificat CAT 2 !

RG	Pret brut	Nr. art.	Model
35		5551-072	Multimetru »Digi-Pocket« complet cu cabluri de masurare (necesita 2 baterii SR 44)

Funcție	Domeniu	Exactitate	Rezolutie
Tensiune continua DC	pana 4 V / pana 40 V pana 400 V / pana 600 V	± 0,5% ± 0,8%	1 mV / 10 mV 100 mV / 1 V
Tensiune alternativa AC	pana 4 V / pana 40 V pana 400 V / pana 600 V	± 1,2% ± 1,2%	1 mV / 10 mV 100 mV / 1 V
Curent continuu DC	pana 40 mA pana 400 mA	± 2,0% ± 2,0%	10 μA 100 μA
Curent alternativ AC	pana 40 mA pana 400 mA	± 3,5% ± 3,5%	10 μA 100 μA
Rezistenta	400 Ω / 4 kΩ / 400 kΩ / 4 MΩ / 40 MΩ	40 kΩ ± 1,5% ± 3,0%	0,1 Ω / 1 Ω / 10 Ω 100 Ω / 1 kΩ / 10 kΩ

5563-... »CLAMPMETRU DIGITAL

- functie **autorange**, salvarea valorilor masurate, tasta valoare relativa masurata
- inchidere **automata**, testare stadiu baterie
- cifre mari = citire fara erori

masoara **tensiunea**
DC: pana la 1000 V, AC: pana la 700 V
masoara **curentul** AC/DC: pana **1000 A**
masoara **rezistenta**: pana 40 MΩ
masoara **frecventa**: pana 100 kHz
masoara **capacitatea**: pana 40 μF
precum si semnalizator de trecere
si test diode



NOU! Acum suplimentar:

masoara **temperatura** cu perla termica, 1 mm Ø:
-40 pana +750°C

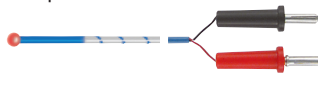

Verificat CAT 2 / CAT 3!

RG	Pret brut	Nr. art.	Model
35		5563-020	»Clampmetru digital in valiza cu cabluri masurare si perla termica(necesita baterie de 9 V)
		5554-039	geanta disponibila inclusa

Funcție	Domeniu	Exactitate	Rezolutie	Supraincarcare
Tensiune continua DC Impedanta 10 MΩ	0,4 V 4 V 40 V 400 V 1000 V	± 0,7% ± 1 d ± 0,7% ± 1 d ± 0,7% ± 1 d ± 0,7% ± 1 d ± 0,8% ± 3 d	0,1 mV 1 mV 10 mV 0,1 V 1 V	1000 V DC sau 700 V AC rms
Tensiune alternativa AC Domeniu frecventa 40 - 400 Hz Impedanta 10 MΩ	4 V 40 V 400 V 700 V	± 0,8% ± 5 d ± 0,8% ± 5 d ± 0,8% ± 5 d ± 1,0% ± 10 d	1 mV 10 mV 0,1 V 1 V	
Curent continuu DC	400 A 1000 A	± 3,0% ± 3 d ± 3,0% ± 3 d	0,1 A 1 A	max. 120% din spatii pentru 60 sec.
Curent alternativ AC Domeniu frecventa 50 - 60 Hz	400 A 1000 A	± 3,0% ± 3 d ± 3,0% ± 3 d	0,1 A 1 A	
Rezistenta	400 Ω 4 kΩ 40 kΩ 400 kΩ 4 MΩ 40 MΩ	± 1,2% ± 1 d ± 1,2% ± 1 d ± 1,2% ± 1 d ± 1,2% ± 1 d ± 1,2% ± 1 d ± 2,0% ± 3 d	0,1 Ω 1 Ω 10 Ω 0,1 kΩ 1 kΩ 10 kΩ	250 V DC sau 250 V AC rms in toate spatii
Capacitate	4 nF 40 nF 400 nF 4 μF 40 μF	± 4,0% ± 10 d ± 4,0% ± 10 d ± 4,0% ± 10 d ± 4,0% ± 10 d	1 pF 10 pF 0,1 nF 1 nF 10 nF	
Frecventa Domeniu masurare 1 - 10 V rms 10 Hz - 100 kHz	40 Hz 400 Hz 4 kHz 40 kHz 100 kHz	± 2,0% ± 1 d ± 2,0% ± 1 d ± 2,0% ± 1 d ± 2,0% ± 1 d ± 2,0% ± 1 d	0,01 Hz 0,1 Hz 1 Hz 10 Hz 0,1 kHz	
Temperatura	-40 pana 0°C 0 pana 400°C 400 pana 750°C	± 1,0% ± 6 d ± 1,0% ± 3 d ± 1,0% ± 5 d	1°C 1°C 1°C	

Alti senzori de temperatura
vezi termometre pe paginile urmatoare!

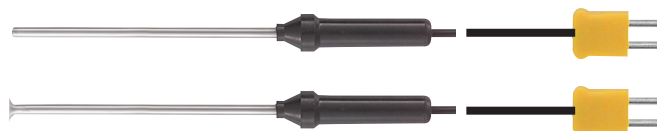

8522-... »VERIFICATOR CABLURI ELECTRICE

cu afisaj **acustic** si **optic**

- Rezistenta masurare **pana 900 Ω**
 1. semnal acustic
 - LED-urile 2. 900 Ω si 90kΩ lumineaza
- Rezistenta masurare **>900 Ω** pana **90 kΩ**
 1. semnal acustic
 2. LED-ul 90 Ω lumineaza
- **Verificarea polaritatii** semiconductorilor
 1. in **sensul de trecere** ca rezistenta de trecere pana 900 Ω
 2. in **directia de blocare** fara aprindere si fara semnal sonor
- **Funcie lanterna**



distribuit de Katech

RG	Pret brut	Nr. art.	Denumire
35		8522-014	Dutest-Control

8524-... APARAT INDICATOR FAZE ELECTRICE

la racordarea celor 3 faze se aprinde campul lampa ce corespunde acestui camp electric, nelipsit la racordarea motoarelor pe curent alternativ

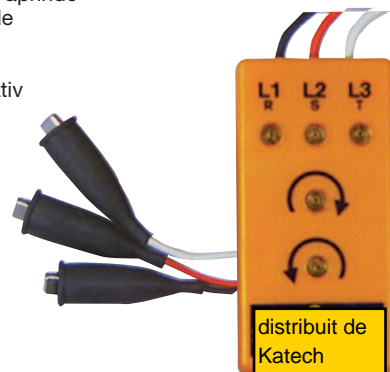

distribuit de Katech

RG	Pret brut	Nr.art.	Denumire
35		8524-017	Aparat indicator faze electrice

5566-... DIGI-ISOTESTER, Aparat de verificare a izolatiei

aparat industrial robust cu **dispozitiv digital de masurare, generator de tensiune** 500 V / 1000 V si set cabluri de verificare

- masoara rezistenta izolatiei, rezistenta la treceri



RG	Pret brut	Nr. art.	ptr	Domeniu	rezolutie
35		5566-011	rezistenta izolatie masurarea rezistentei	200 MΩ 1000 MΩ 200 Ω	0,1 MΩ 1 MΩ 100 mΩ

5564-... WATTMETRU PUTERE ACTIVA »DIGI-WATT«

aparat industrial robust, forma compacta, cu **dispozitiv digital de masurare**, cu set cabluri de verificare, in geanta

- pentru masurarea **puterii active** pana la 6000 W la curent max. de 10 A, tensiune si amperi



Atentie: curent max. 10 A

RG	Pret brut	Nr.art.	masoara	Domeniu	Rezolutie
35		5564-018	Watti (putere activa)	2000 W 6000 W	1 W 10 W
			tensiune =	200 V 1000 V	100 mV 1 V
			tensiune ≈	200 V 750 V	100 mV 1 V
			curent continuu =	10 A	10 mA
			curent alternativ ≈	10 A	10 mA

7156-... CHEIE TUBULARA CABLAJE PG si EN-50262

Utilizare: la strangerea mufelor de cablare



RG	Pret brut	Nr. art.	ptr.SW mm	ptr.PG / M	maner rabatabil
30		7156-014	15	PG 7 /	
		7156-090	17		
		7156-022	19	PG 9 / M 16	
		7156-031	20	PG 11 /	
		7156-081	22		
		7156-049	24	PG 13,5 / M 20	
		7156-103	25		
		7156-057	27	PG 16 / M 25	
		7156-111	30		
		7156-065	33	PG 21 / M 32	
		7156-120	34		
7156-154	36				
7156-138	41				
7156-073	42	PG 29 / M 40			
7156-146	50				

1902-... CLESTE MUFE CABLAJE conform PG si EN-50262

la strangerea mufelor de cablare



cu suprafata dintata de prindere

RG	Pret brut	Nr. art.	ptr. SW/mm	ptr. PG / M
47		1902-016	14 - 33	PG 7 - 21 / M 16 - 21

1902-... »CHEIE REGLABILA MUFE CABLAJE

Deschiderea cheii este reglabila in trepte cu ajutorul mecanismului, functie clichet



pentru strangerea mufelor de cablare

RG	Pret brut	Nr. art.	pentru SW/mm	Pret brut	Nr. art.	pentru SW/mm
47		1902-024	11 - 24		1902-032	24 - 36

5552-... »DIGI-DUO-THERM« TERMOMETRU RAPID

- -50 pana la + 1300°C (comutabil pe Fahrenheit -58 pana la+ 2000°F)
- foarte **exact**, memorarea valorilor masurate, afisaj de durata la masurari indelungate, masurarea diferentelor
- **cifre foarte mari**, luminoase = citire fara eroare
- inchidere automata
- cu carcasa de protectie cauciucata, suport rabatabil de fixare



2 iesiri cabluri cu perla termica pentru 2 masurari (diferente) simultane

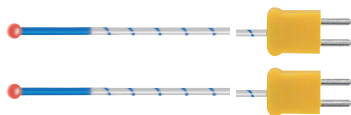
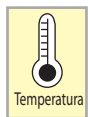

»Digi-Duo-Therm« complet cu 2 senzori cu perle termice (pana la 260°C) 1 mm Ø, in geanta

RG	Pret brut	Nr. art.	Model	Domeniu masurare	rezolutie	baterii
		5552-141	Digi-Duo Therm	-50°C pana + 1300°C	pana+ 200°C 0,1°C de la+ 201°C 1°C	bloc 9 V
		5552-150	Tija termica cu senzori , 3 x 75 mm pentru temperaturi ridicate			
		5552-028	Tija termica cu senzori-de rezerva 3,5 mm Ø x 150 mm:			
35		5552-036	termometru pentru masurarea suprafetelor 7,0 mm Ø x 150 mm:			
		5552-044	Perla termica pe cablu, 2 mm Ø, ultrarapida pana la + 250°C			
		5552-079	Palpatore de suprafata de precizie TP 04: - 50°C pana la + 400°C			

5552-... TERMOMETRU IN INFRAROSU cu vizare laser

- **masurare la distanta a temperaturii, fara atingere**: ideal si in locuri **greu** accesibile, **piese fierbinti**, masini in functiune, **vizare exacta cu ajutorul punctului cu laser**
- comutabil pe Fahrenheit ● fereastra de citire **luminoasa**
- inchidere **automata** ● memorarea valorilor masurate

»Thermo-Pocket« - 20°C pana+ 270°C potrivit in fiecare buzunar

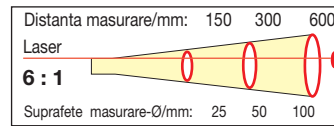

Masurare la distanta fara pericole, acum la pret foarte convenabil!

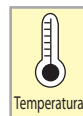

»Thermo-Boy« cu geanta-cu cordon, -50°C pana+ 540°C

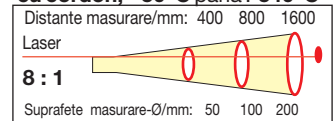

»Thermo-Master« cu geanta cu cordon, - 50°C pana + 750°C

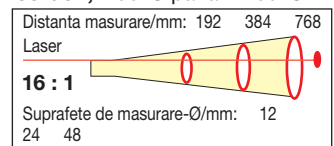

»Thermo-Hi-Temp« in carcasa, - 50°C pana + 1600°C

NOU

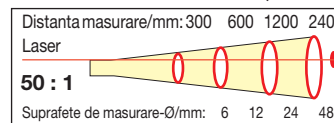

»Thermo-Super« cu geanta cu cordon, - 50°C pana + 1000°C

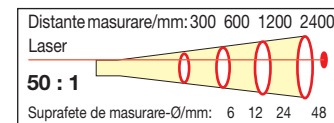

RG	Pret brut	Nr. art.	Model	Dom. masurare	rezolutie	baterii necesare
		5552-125	Thermo Pocket	- 20°C pana + 270°C	1°C	2 buc. Micro LR03
		5552-087	Thermo Boy	-50°C pana + 540°C		
		5552-117	Thermo Master	-50°C pana + 750°C	pana+ 200°C 0,1°C	
35		5552-168	Thermo Super	-50°C pana + 1000°C	de la+ 201°C 1°C	bloc 9 V
		5552-176	Thermo Hi-Temp	-50°C pana + 1600°C		
		5552-184	Thermo Flex	-50°C pana + 600°C		

- **ca mai sus**, cu cablu flexibil de 355mm cu cap contact 30-35 mm masoara si dupa colt
- cifre mari luminoase vizibilitate buna

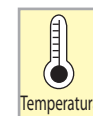

»Thermo-Flex« cu geanta cu cordon, - 50°C pana+ 600°C

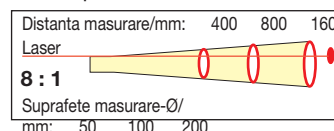

Masurare la distanta fara pericole, acum si dupa colt !

5569-... APARAT DE MASURARE A NIVELULUI ZGOMOTELOR

- 2 domenii de masurare (30 - 100 si 60 - 130 dBA), pentru masurari de moment sau in medie, in domeniul de frecvente 31,5 Hz - 8 kHz, selectarea prealabila a domeniului (dBA = auzit, dBC = frecventa joasa), afisare valoare maxima, salvare valori masurare
- cu afisaj luminos, vizibilitate buna, inchidere automata, filet stativ si dispozitiv-protectie vant impotriva zgomotelor produse de vant



masoara zgomotele de la 30 - 130 dBA (0,5 dBA rezolutie) cu cea mai buna exactitate

Lupta impotriva zgomotelor!

NOU



RG	Pret brut	Nr. art.	Executie	baterii necesare
35		5569-010	masoara zgomotul 30 - 130 dBA, in carcase	9 V

5597-... UMIDOMETRU

- citire usoara, cu inchidere automata si clips de prindere
- cu 2 varfuri de masurare, 8 mm lungime, precum si casca verificare pentru testul statutului bateriei si functionarii
- mic, usor, comod, mereu la indemana, utilizare simpla



umiditate

masoara umiditatea hartiei si lemnului 6 - 44% (1% rezolutie) precum si umiditatea in constructii 0,2 - 2% (0,05% rezolutie)

NOU



RG	Pret brut	Nr. art.	Executie	baterii necesare
35		5597-030	umidometru	3 buc. CR2032

5567-... LUXMETRU »DIGI-LUX«

Executie: aparat industrial, robust constructie compacta; cu memorarea automata a valorilor masurate si maxime, precum si inchidere automata; in geanta



Utilizare: masoara rapid intensitatea corecta a luminii, la orice loc de munca



RG	Pret brut	Nr. art.	masoara	Domeniul	rezolutie	baterii necesare
35		5567-025	Lux (intensitatea)	200 Lux 2.000 Lux 20.000 Lux 50.000 Lux	0,1 Lux 1 Lux 10 Lux 100 Lux	bloc 9 V

5597-... UMIDOMETRU DIGITAL

cu senzor pentru suprafete si afisaj digital pentru citire simpla

Utilizare: ideal pentru toate atelierele de prelucrare a lemnului, zugravi, amenajari interioare, firme de constructii, tehnicieni, arhitecti s.a.m.d.



umiditate



RG	Pret brut	Nr. art.	Executie	baterii necesare
35		5597-021	cu senzor pentru suprafete pentru lemn si beton	bloc 9 V

Aparate de masurare, speciale pentru ateliere de mecanica, vezi catalog grupa H, respectiv cuprinsul!

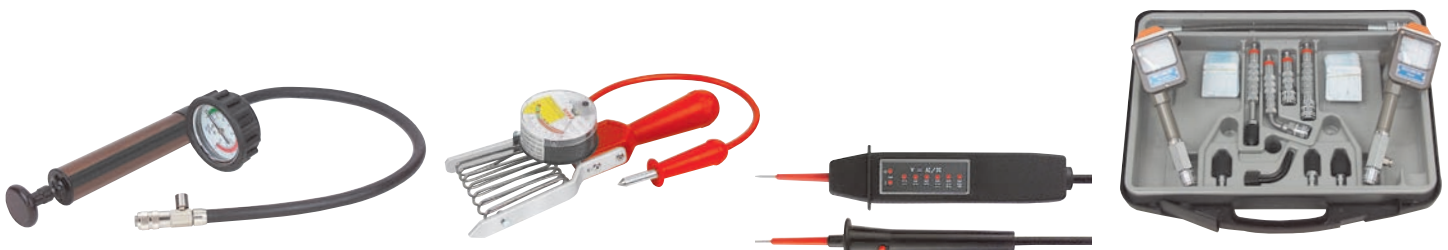

ex.verificator faze, aparat de inregistrare a presiunii, tester baterie, verificator presiune in camera, dinam-pistol s.a.m.d.

5565-... »DIGI-DUO« ANEMOMETRU CU PALETE (masurator vant)

- ideal pentru tehnica de incalzire si ventilatie, constructii, statii meteo, Sport s.a.m.d.
- roata cu palete fara frecare, **precizie ridicata a rotirii concentrice**
- masoara urgent + **exact** si adieri **usoare**
- cifre mari luminoase = **citire fara eroare**

Vant masoara **viteza vantului** (curenti de aer): **0 - 140 km/h**, 0 - 45 m/sec., 0 - 88 noduri (memorare valoare max. si valori masurate)

Masoara si cele mai usoare miscari ale aerului!

Temperatura masoara **temperatura** cu perle termice, 1 mm Ø - 20°C pana+ 200°C, comutabil pe Fahrenheit (memorarea valorilor maxime si minime si a valorilor masurate)



- cu inchidere automata (economiseste curent) si supraveghere baterie
- cu filet static, geanta , rezistenta la intemperii, curea umar si baterie 9 V



EN 50081-1 / EN 50082-1 / EN 60825-1

RG	Pret brut	Nr. art.	Denumire	baterii necesare
35		5565-022	Anemometru cu palete (masurator vant)	bloc9 V

5565-... DETECTOR gaze explozibile



- **avertizeaza asupra** scurgerii de gaze inflamabile, **explozive** (LPG/LNG), neetanseitati si pericole de explozie de propan, butan, metan, gaz metan, acetilena, vapori de benzina si alcool, s.a.m.d

- semnalizare acustica + **lampa rosie LED**-de avertizare, pentru gaze precum si **lampa galbena LED**-de avertizare pentru incarcari statice



- cu revenire automata a alarmei, intrerupator de pornire/oprire si curea de prindere

cu curea de prindere si clips de agatare: **simplu de agatat= mereu protejat** la lucru, la umpleri, in spatii cu presupuse pericole, la camping, **peste tot**; Domeniu lucru -10° pana+50°C, pana la umiditate de 95%

Protectie simpla mereu si peste tot!

RG	Pret brut	Nr. art.	Denumire	baterii necesare
35		5565-031	Detector de gaze	2 buc. AAA

5552-... »4-FUNCTII« APARAT DE MASURARE A MEDIULUI DE LUCRU



masoara **zgomotul** 35 - 100 dB (rezolutie 1 dB)



masoara **umiditatea relativa a aerului** 35 - 95% (0,1% rezolutie)

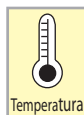

masoara **temperatura** - 20 pana 200°C (0,1°C) - 20 pana 750°C (1°C), comutabil pe F

- complet cu **geanta**

RG	Pret brut	Nr. art.	Model	baterie necesara
35		5552-133	Aparat de masurare a mediului de lucru, cu 4-functii	bloc 9 V

5565-... DETECTOR gaze explozibile - flexibil

- **avertizeaza si la cele mai mici cantitati de gaze**, inflamabile, **explozive** (neetanseitati) precum gaz metan, propan, butan, metan precum si vapori de benzina, kerosen, alcool, solventi si dizolvanti sau asemanatoare; timp de prelucrare, doar **2 secunde**

- **rozeta de calibrare** pentru setarea exacta a sensibilitatii: Afisaj avertizare: **optica** (LED) si **acustica**(ticait tipic contoarelor)

- cu intrerupator pornire/oprire, racord casti, geanta cu cordon



Domeniu de lucru: -10° pana +50°C, pana la 90% umiditatea aerului

Ideal pentru instalatori, chimie petroliera, gresarii/faiantari, vopsitori s.a.m.d.!

RG	Pret brut	Nr. art.	Executie	baterii necesare
35		5565-049	Detector gaze explozibile flexibil	3 buc. Babyz.

Prin conditii de lucru optime- la realizari optime!



5578-... CARCASA CANTAR CU TALER

Executie: galvanizat, geam din acril-cu protectie impotriva lovirii, reglare Tara; cu fixare la locul stabilit prin insurubare sau sudare

RG	Pret brut	Nr.art.	Domeniu cantarire Gradare	Executie
97		5578-019	0 - 5 kg / 100 g	Scala 180 mm Ø
		5578-027	0 - 10 kg / 150 g	
		5578-035	0 - 20 kg / 100 g	
		5578-060	0 - 30 kg / 100 g	Scala 230 mm Ø
		5578-078	0 - 50 kg / 200 g	Scala 250 mm Ø
		5578-108	0 - 100 kg / 200 g	



5547-... CANTAR CU ARC - DINAMOMETRIC

cantar usor, foarte precis cu scala neagra pe tija interioara argintata; tija, inel si carlig nichelate ;recomandat pentru **masurari fine** respectiv **cantariri fine**

RG	Pret brut	Nr.art.	Domeniu cantarire Gradare	Pret brut	Nr.art.	Domeniu cantarire Gradare
97		5547-016	0 - 0,1 kg / 1 g		5547-067	0 - 5 kg / 50 g
		5547-024	0 - 0,2 kg / 2 g		5547-075	0 - 10 kg / 100 g
		5547-032	0 - 0,5 kg / 5 g		5547-083	0 - 20 kg / 200 g
		5547-041	0 - 1,0 kg / 10 g		5547-091	0 - 25 kg / 200 g
		5547-059	0 - 2,0 kg / 20g		5547-105	0 - 50 kg / 500 g



5577-... BALANTA SUSPENDATA

Executie: Carcasa din otel emailat (Nr. art. 5577-101 carcasa calita din aluminiu), geam din acril, cu protectie antilovire, reglaj Tara

Utilizare: pentru **cantarire** precum si pentru **masurarea fortei de tractiune**

RG	Pret brut	Nr.art.	Domeniu cantarire Gradare	Executie
97		5577-012	0 - 5 kg / 20 g	carcasa otel emailat, scala 150 mm Ø
		5577-021	0 - 15 kg / 50 g	
		5577-039	0 - 25 kg / 100 g	
		5577-047	0 - 50 kg / 200 g	
		5577-055	0 - 100 kg / 500 g	
		5577-101	0 - 200 kg / 500 g	carcasa din otel calit, scala 250 mm Ø



4821-... BALANTA DIGITALA SUSPENDATA

Executie: cu inchidere automata sau afisare de durata, cu comutare iluminat fundal, afisaj LED mare si **bine lizibil**, Domeniu tarare 100 %; complet cu baterii (ca. 250 ore de functionare)

RG	Pret brut	Nr.art.	Domeniu cantarire Gradare	Executie
97		4821-017	0 - 30 kg / 20 g	afisaj LED mare(24 mm)



4820-... CANTAR DIGITAL PT. MACARALE cu telecomanda

Executie: carcasa etansa, robusta; carlig pana la 2 to rotativ, de asemenea rabatabil; acumulator 6V integrat, pentru ca. 80-120 ore; parte electrica moderna; cifre luminoase de 25 mm; cu incarcator;

Funcții:

- setare automata la zero
- fixarea greutatilor
- functie tarare pana la sarcina maxima

Div. avantaje:

- citire usoara - si la distante mari
- telecomanda pana la distanta de 15 m
- siguranta ridicata impotriva ruperii la sarcina



RG	Pret brut	Nr.art.	Model	Domeniu cantarire	Citare/Gradare
97		4820-100	0,6 T	0 - 600 kg	0,2 kg
		4820-011	1,0 T	0 - 1.000 kg	0,5 kg
		4820-037	3,0 T	0 - 3.000 kg	1,0 kg
		4820-045	5,0 T	0 - 5.000 kg	2,0 kg
		4820-070	7,5 T	0 - 7.500 kg	5,0 kg