

Koine

lo strumentario

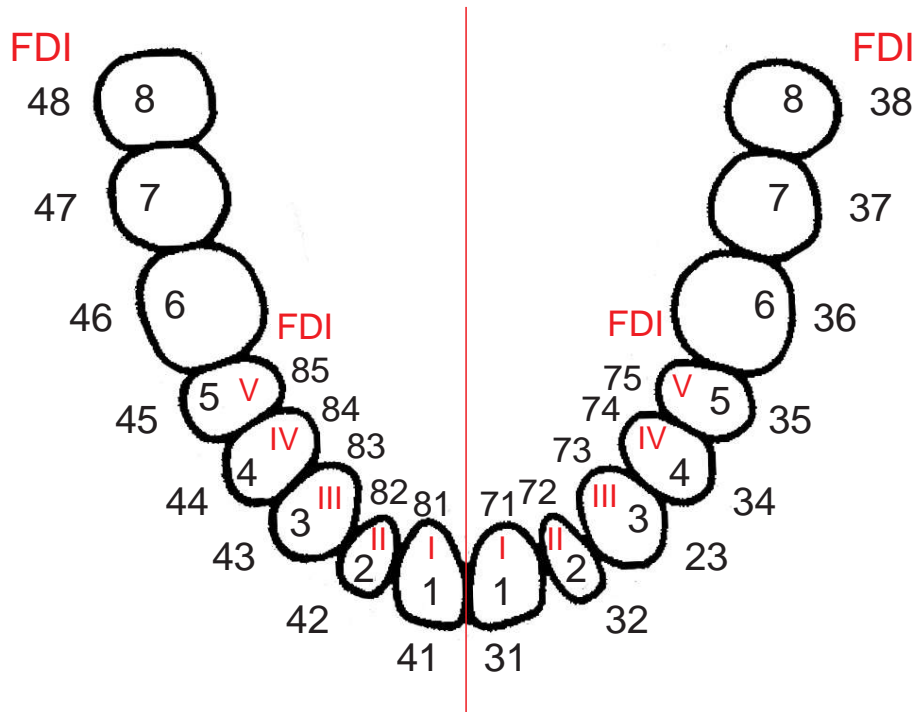

supporti universali
del vostro prestigio

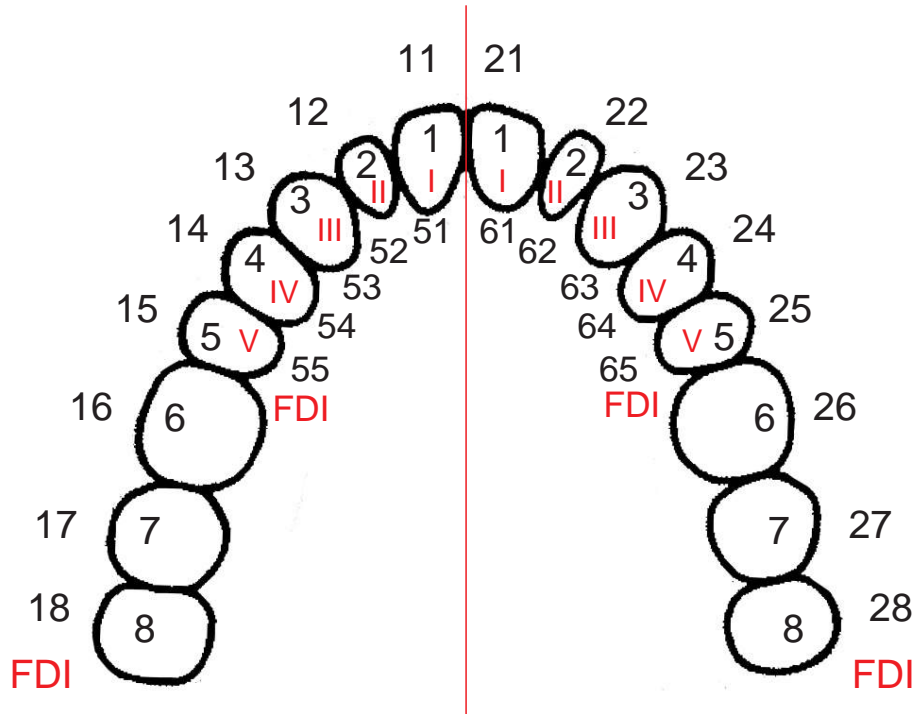



Manici per bisturi

Scalpel blade holders

Skalpell klingenthaler

Mangos de bisturi

Strumentario

Koine



← 140 →

KN 02.030.16



← 145 →

KN 02.030.15



← 140 →

KN 02.030.30



← 140 →

KN 02.020.04



← 165 →

KN 02.030.70

Sfla lama

Strumentario

Koine

Scalpel blade remover

Skalpellklingenentferner

Pinza para quitar hojas



KN 02.045.16

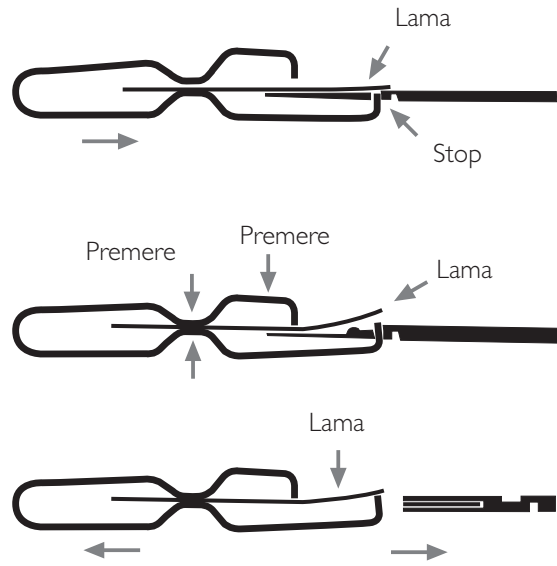

KN 02.045.17

03

04

05

Forbici - Forbic TC

Koine



Forbici

Scissors

Scheren

Tijeras

Strumentario

Koine



IRIS diritta
KN 03.320.11



IRIS curva
KN 03.321.11



IRIS angolata
KN 03.325.11



IRIS curva di taglio
KN 03.323.11

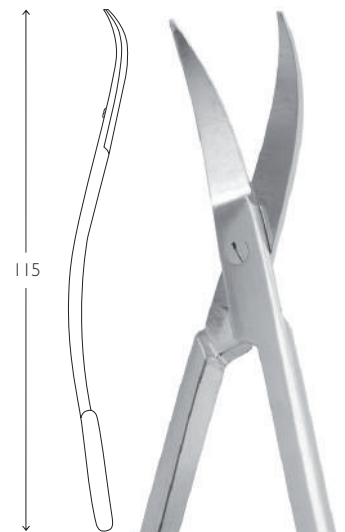

LA GRANGE
KN 03.401.11

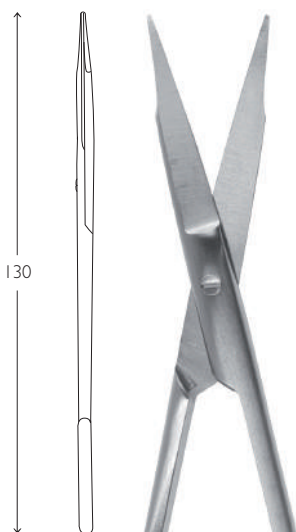

GOLDMAN - FOX diritta
KN 03.412.13



GOLDMAN - FOX CURVA
KN 03.417.13

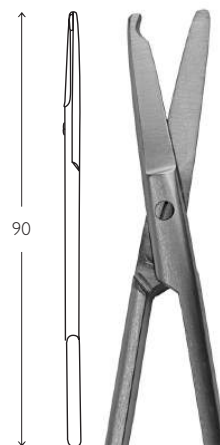

SPENCER
KN 03.720.09

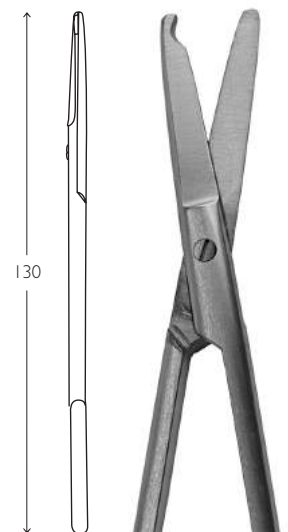

SPENCER
KN 03.720.13

Forbici

Strumentario

Koine

Scissors

Scheren

Tijeras

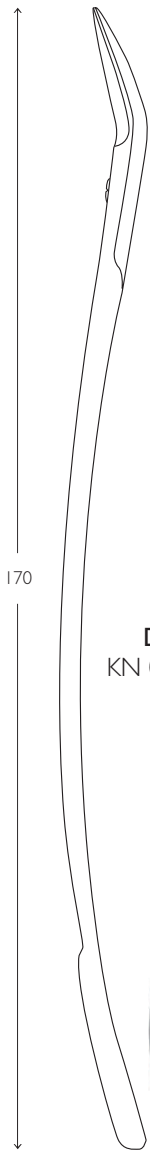

DEAN
KN 03.497.17

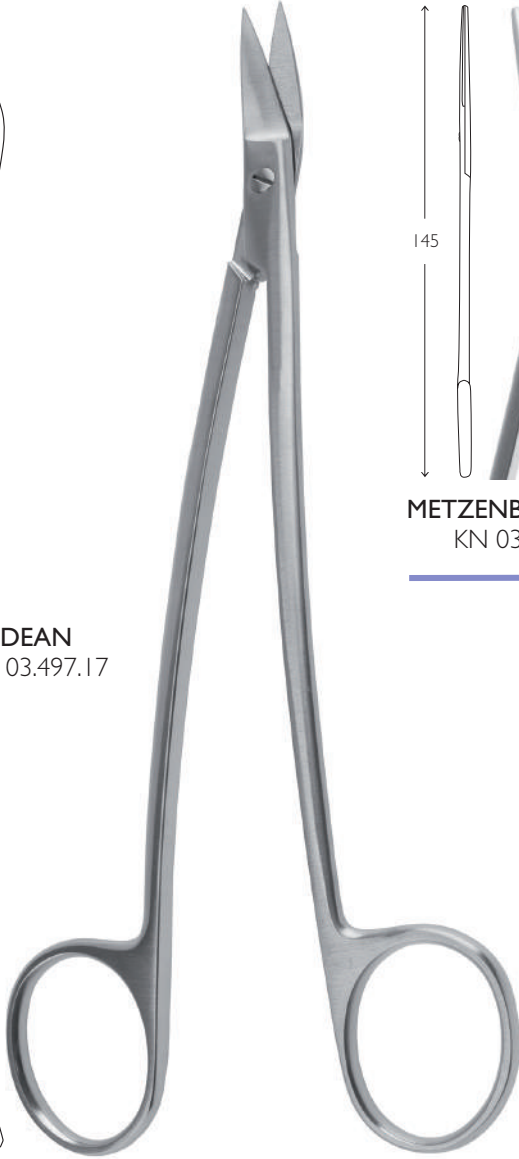

METZENBAUM diritta
KN 03.080.14



METZENBAUM curva
KN 03.081.14

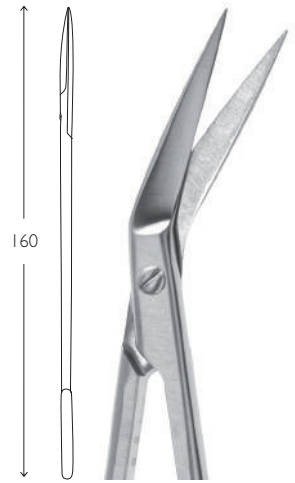

LOCKLIN
KN 03.420.00

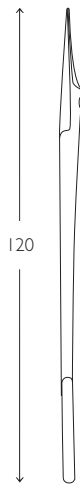

QIMBY diritta
KN 03.410.12



QIMBY curva
KN 03.411.12



JOSEPH diritta
KN 03.440.14



JOSEPH curva
KN 03.441.14

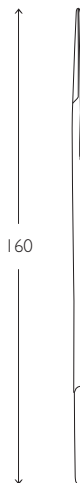

KELLY diritta
KN 03.630.16

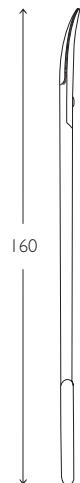

KELLY curva
KN 03.631.16



Crown scissors

Kronenscheren

Tijeras para coronas

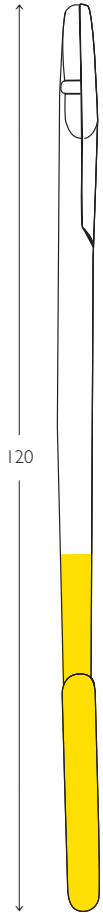

UNIVERSALE TC
KN 04.741.12
(Ph.1/1)

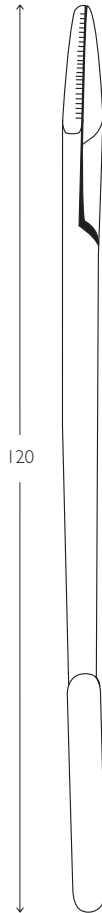

UNIVERSALE INOX
KN 03.741.12

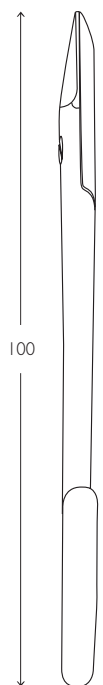

BEEBE diritta
KN 03.744.10

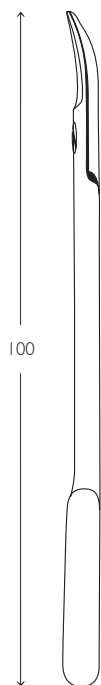

BEEBE curva
KN 03.745.10

- Forbici TC
- Scissors TC
- Scheren TC
- Tijeras TC



IRIS
diritta TC
KN 04.520.11



IRIS
curva TC
KN 04.521.11



GOLDMAN - FOX
diritta TC
KN 04.412.13

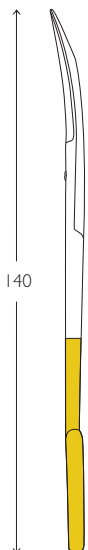

GOLDMAN - FOX
curva TC
KN 04.417.13

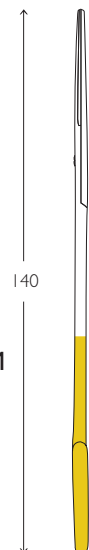

METZENBAUM
diritta TC
DELIKAT
KN 04.328.14

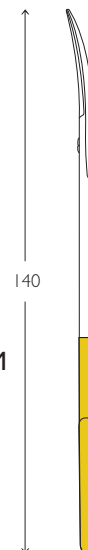

METZENBAUM
curva TC
DELIKAT
KN 04.327.14

Forbici

Scissors

Scheren

Tijeras

Strumentario

Koine

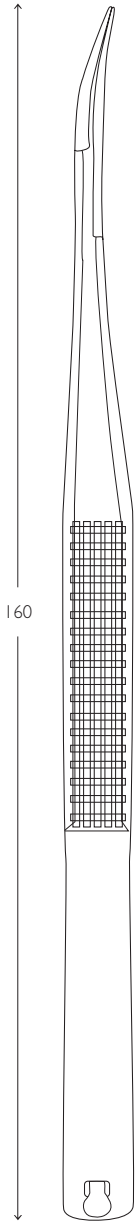

GOMEL
KN 05.045.16
(Ph.1/1)

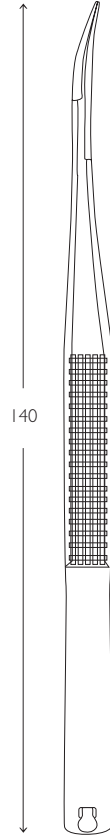

GOMEL
KN 05.045.14

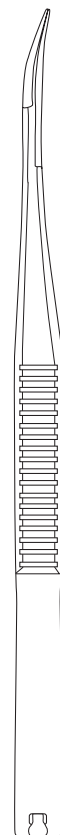
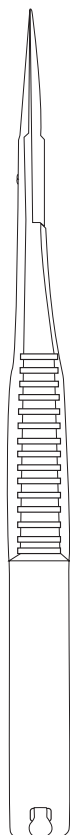

NOYES CURVA
KN 05.161.12



NOYES DIRITTA
KN 05.160.12

Forbici

Scissors

Scheren

Tijeras

Strumentario

Koine

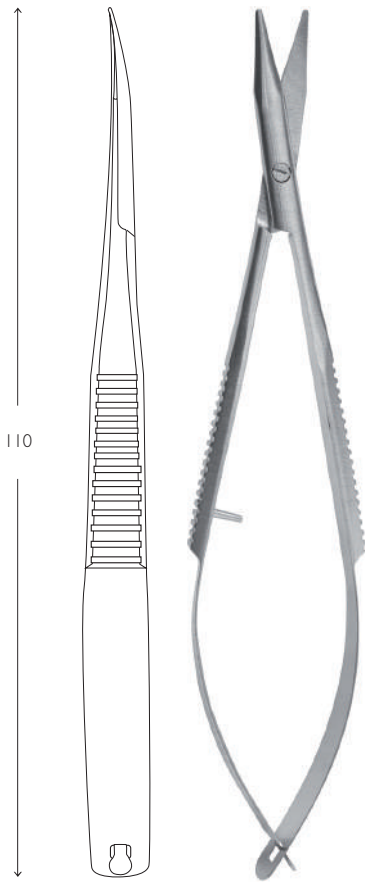

WESCOTT DIRITTA
(punte smusse)
KN 05.152.11

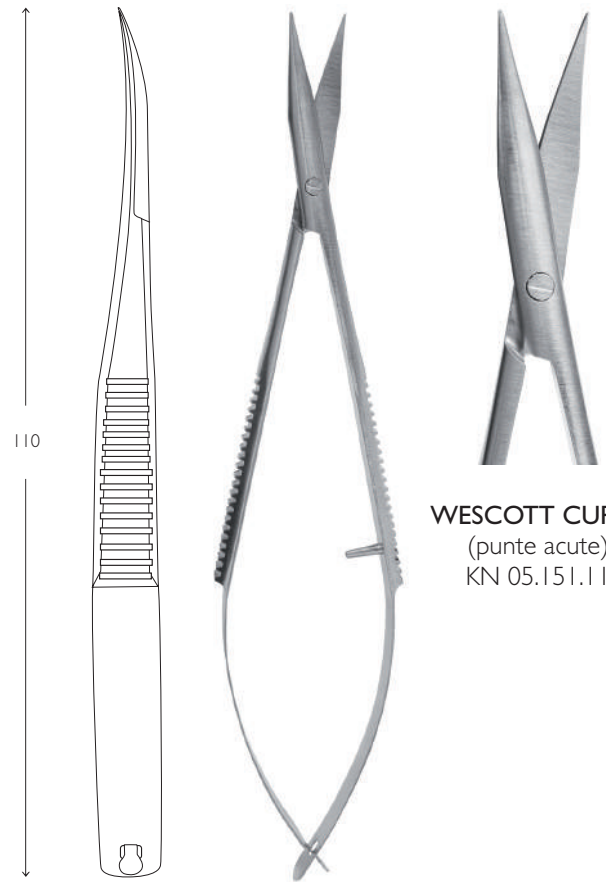

WESCOTT CURVA
(punte acute)
KN 05.151.11

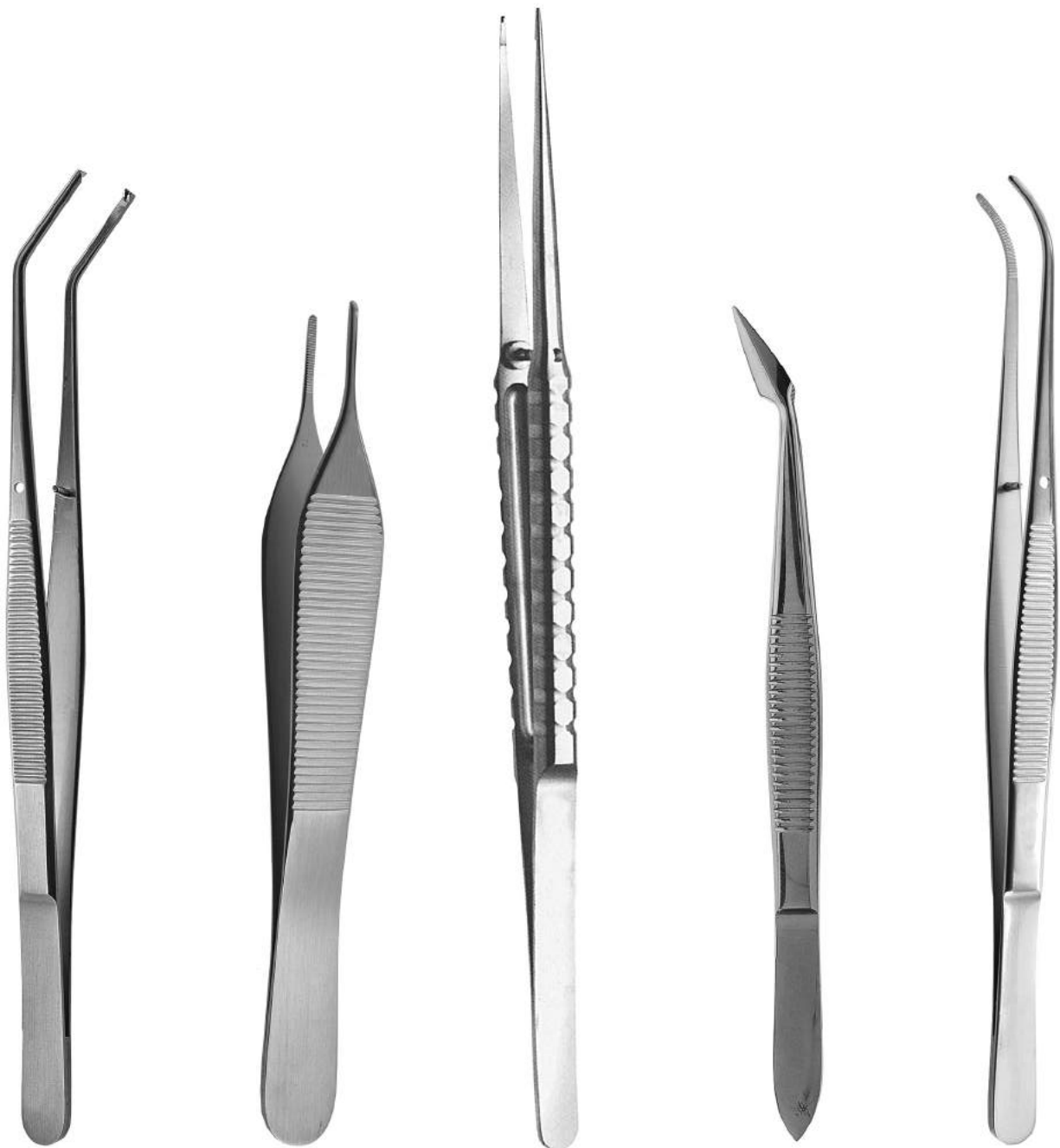

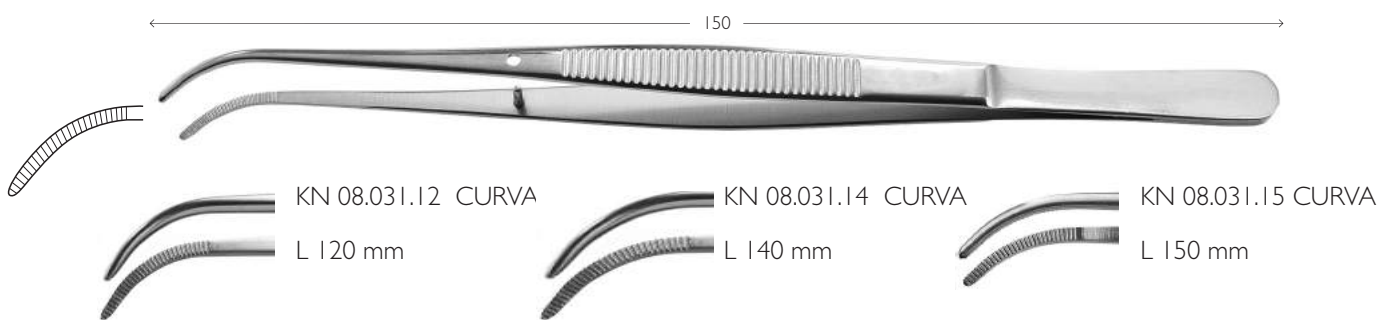
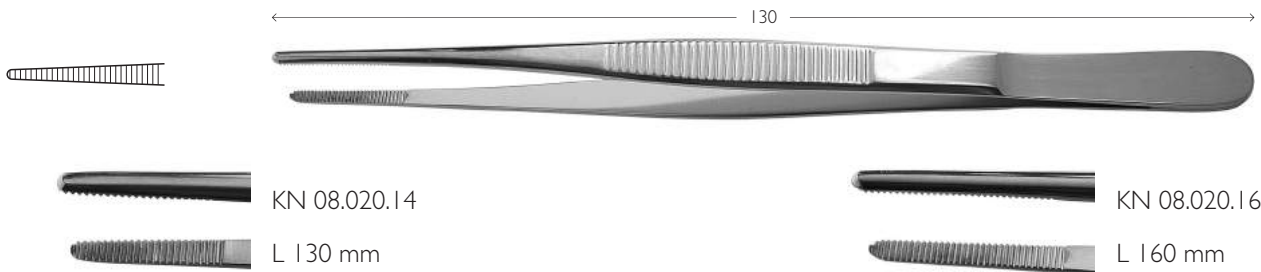

Semken

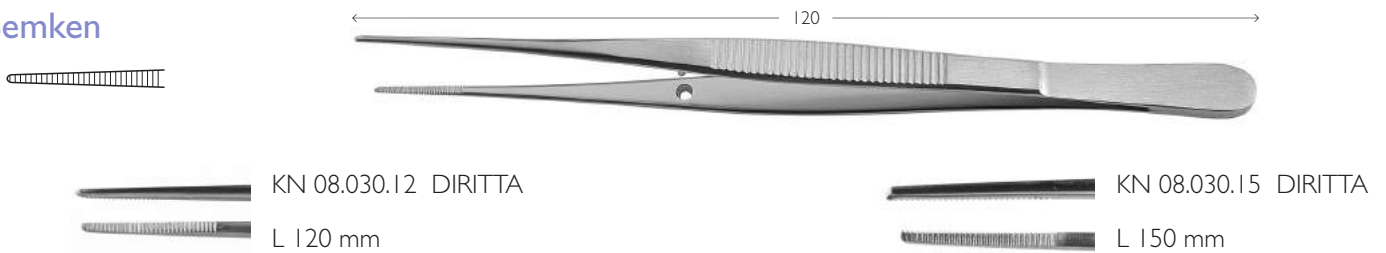

Adson

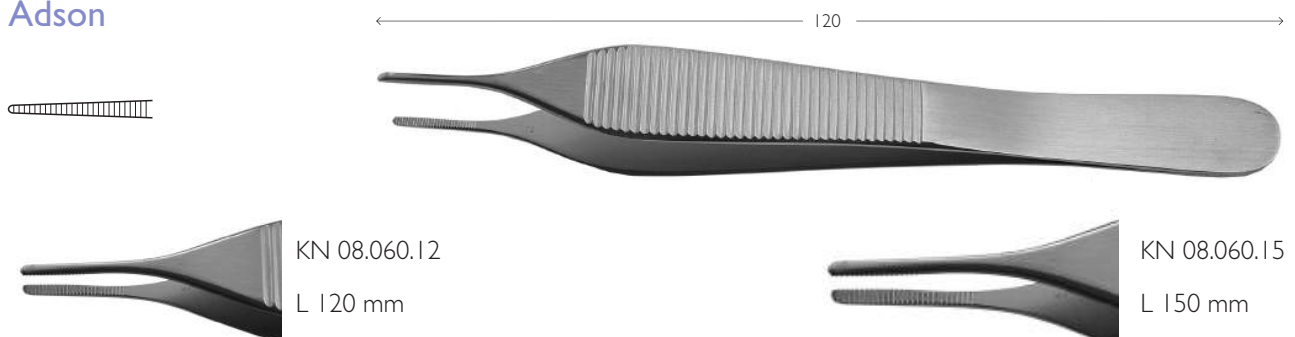

Pinzette anatomiche

Strumentario

Koine

Anatomic forceps

Anatomische Pinzetten

Pinzas anatomicas

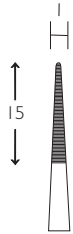

← 100 →



KN 08.030.10

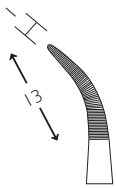

← 100 →



KN 08.031.10



← 100 →



KN 08.453.10

SCHEGGE HUNTER



← 100 →



KN 08.452.10

SCHEGGE HUNTER

Adson Brown

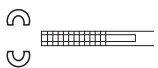

← 120 →



KN 08.267.12

Pinzette chirurgiche

Strumentario



Surgical forceps

Chirurgische Pinzetten

Pinzas quirurgicas

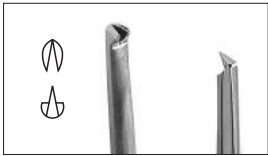

← 130 →

KN 08.120.14 L 140 mm

KN 08.120.16 L 160 mm

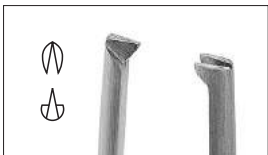

← 150 →

KN 08.040.15 L 150 mm

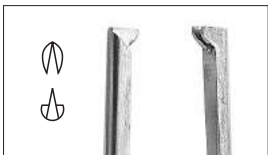

← 150 →

KN 08.041.15 L 150 mm



← 140 →

KN 08.121.14 L 140 mm

KN 08.121.16 L 160 mm

Pinzette chirurgiche

Strumentario



Surgical forceps

Chirurgische Pinzetten

Pinzas quirurgicas

Adson Standard

KN 08.061.12



1,5

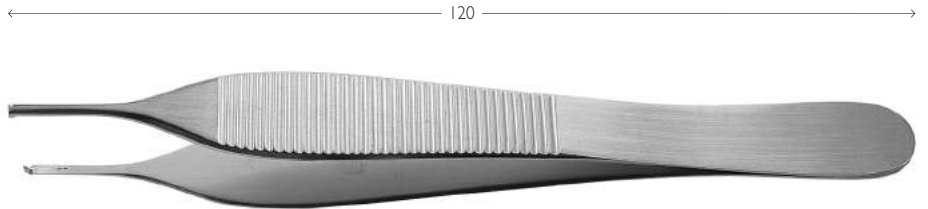

Adson Standard

KN 08.061.15



1,5

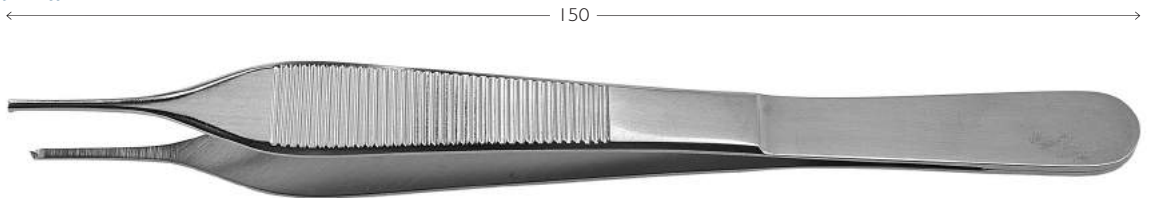

Adson Extrafine

KN 08.262.12



1,5

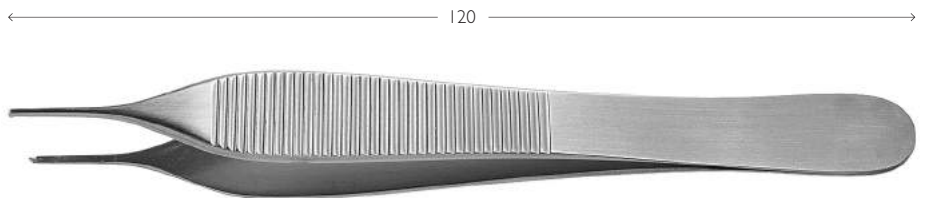

Adson Extrafine

KN 08.262.15



0,8

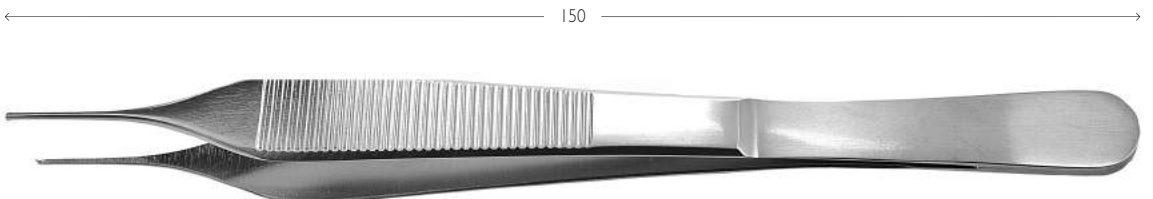

- Pinzette extrafini
- Tweezers extrafine
- Pinzetten extrafein
- Pinzas extrafinas

Anatomiche Extra Fini

← 170 →



KN 08.300.17 DIRITTA



KN 08.301.17 CURVA



1,8
GGI

KN 08.320.00 DIRITTA



1,3
GGI

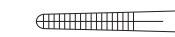

curva 30°



Chirurgiche Extra Fini

← 170 →



1,3
GGI

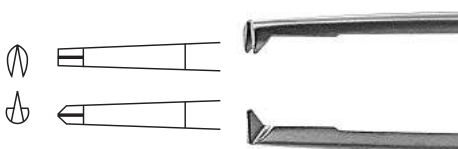

KN 08.310.17

DIRITTA

KN 08.311.17

CURVA

curva 30°





Pinzette medicazioni

Strumentario

Koine

Dressing pliers

Zahnpinzetten

Pinzas dentales



150

KN 10.801.15 COLLEGE



160

KN 10.841.16 MERIAM



160

KN 10.831.16 FLAGG



150

KN 10.885.15 C/STOP



150

KN 10.883.15 C/STOP PER CONI

Pinze carta articolazione

Strumentario



Articulating paper pliers

Papierpinzette

Pinza para papel de articulacion

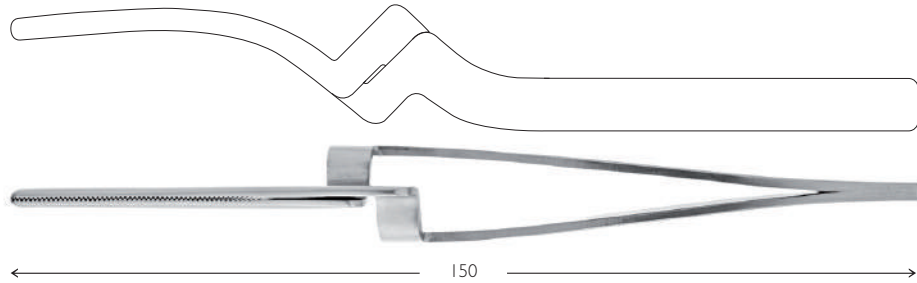
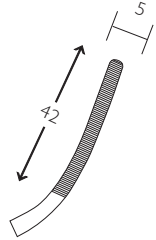

KN 10.948.15

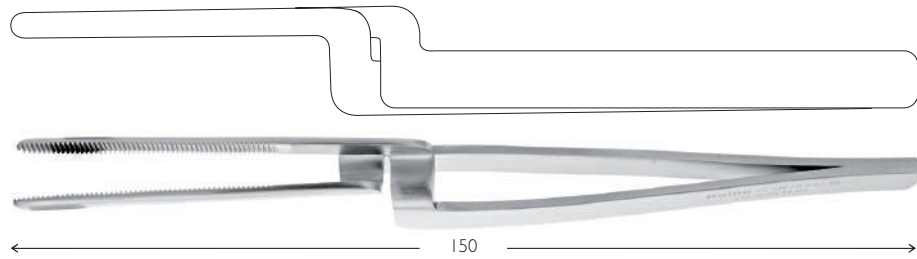
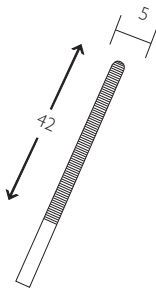

KN 10.947.15

Pinzette chirurgiche

Crane Kaplan

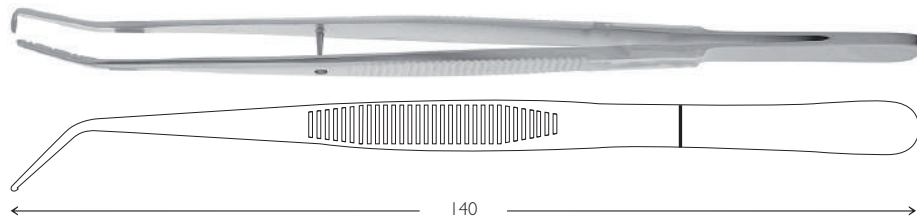
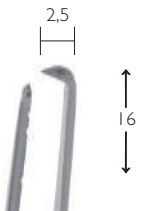

KN 10.903.15

Crane Kaplan

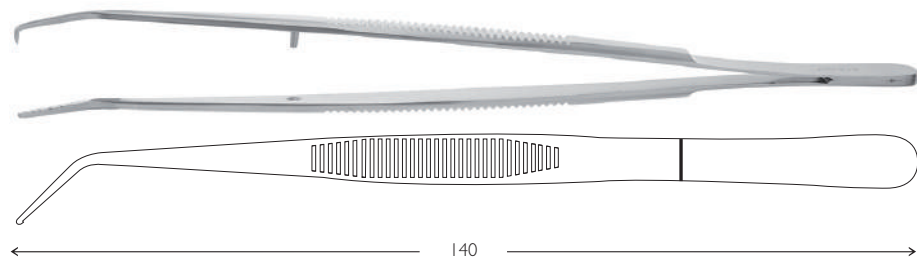

KN 10.905.15

Pinzette per sutura



KN 10.871.16



Calibri

Strumentario



Dental callipers



Dental Messschieber



Calibre dental

CALIBRO CASTROVIEJO

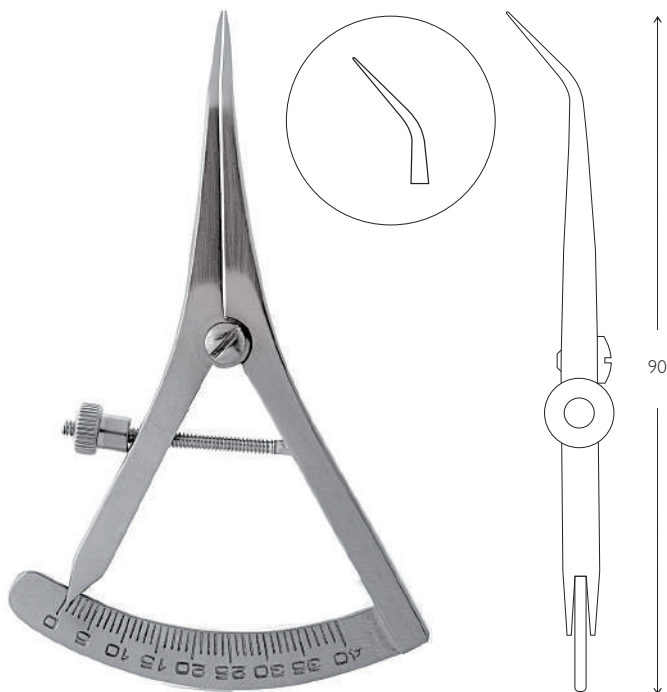

KN 10.943.09 CURVO

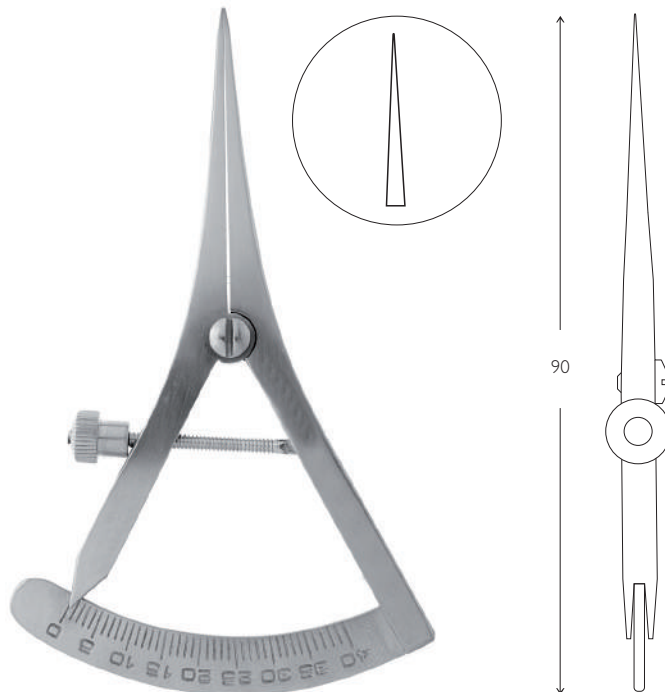

KN 10.942.09 DIRITTO

CALIBRO IWANSON

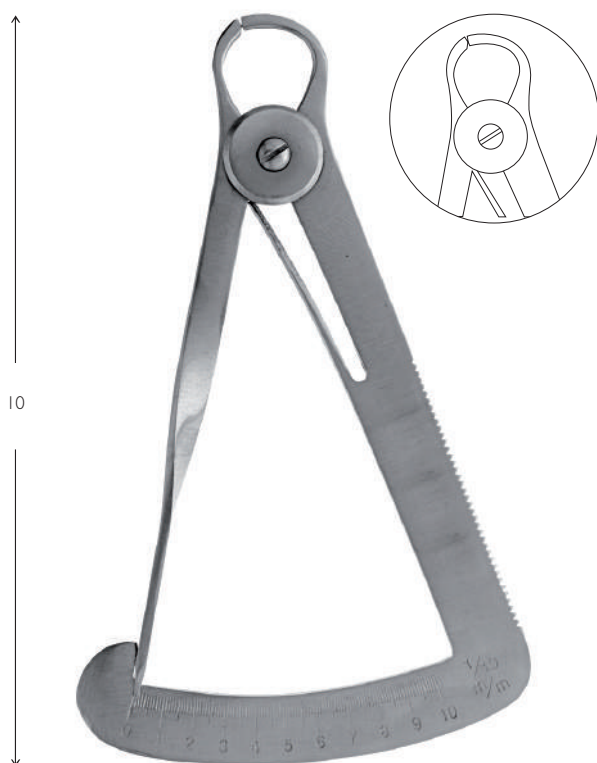

KN 10.941.01 PER CERA

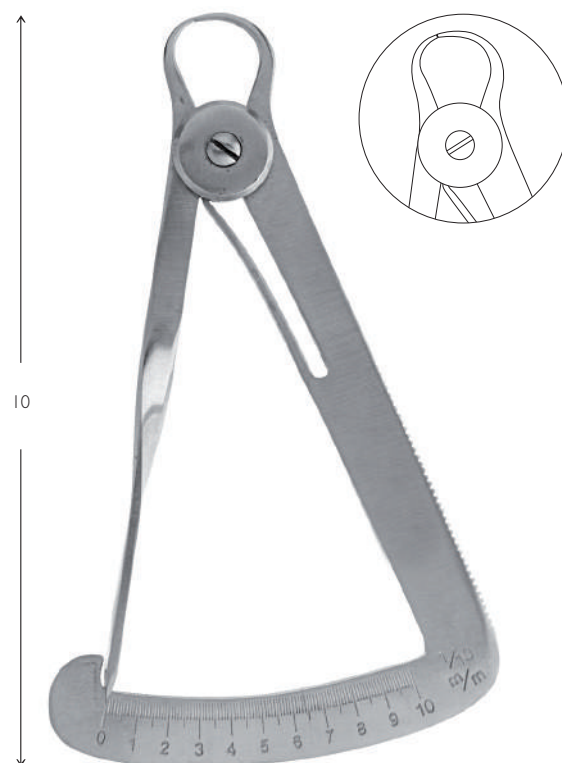

KN 10.941.00 PER CORONA

- Dental callipers
- Dental Messschieber
- Calibre dental

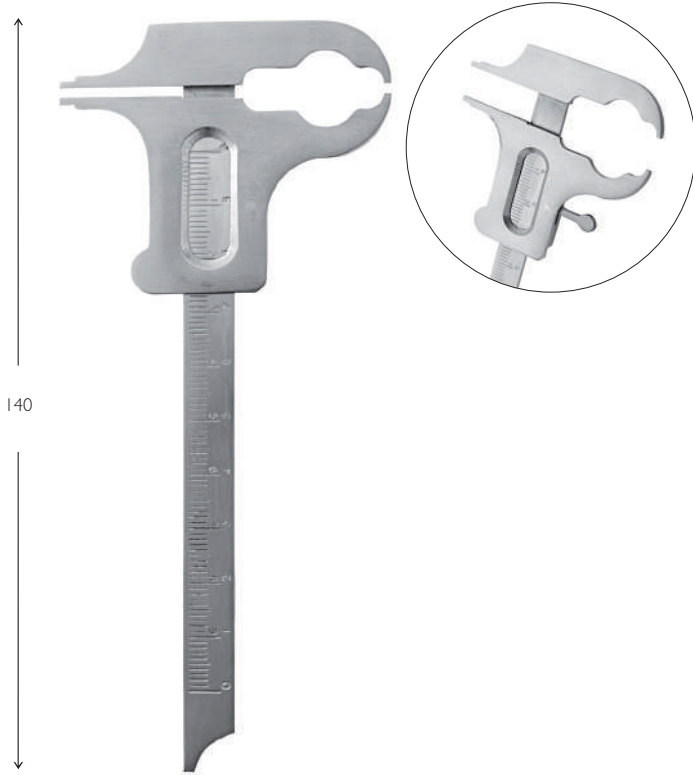

CALIBRO BOLEY KN 10.945.00

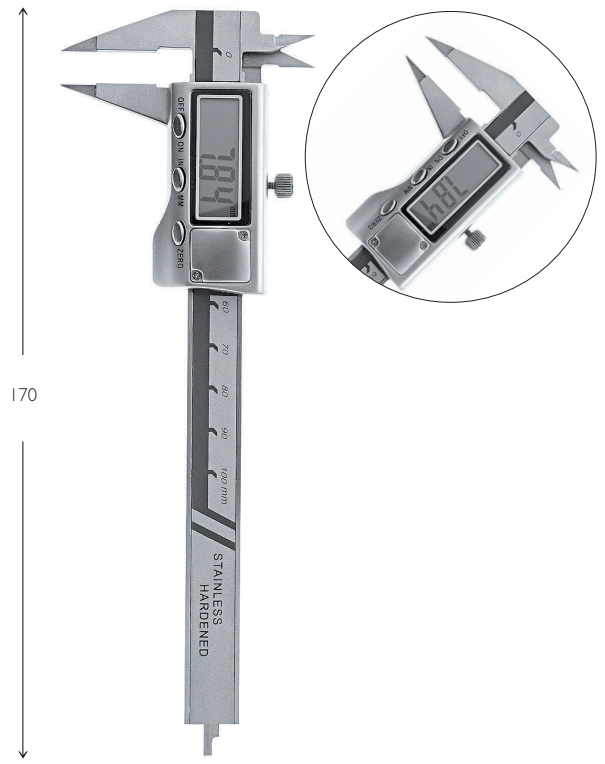

CALIBRO DIGITALE KN 10.950.00

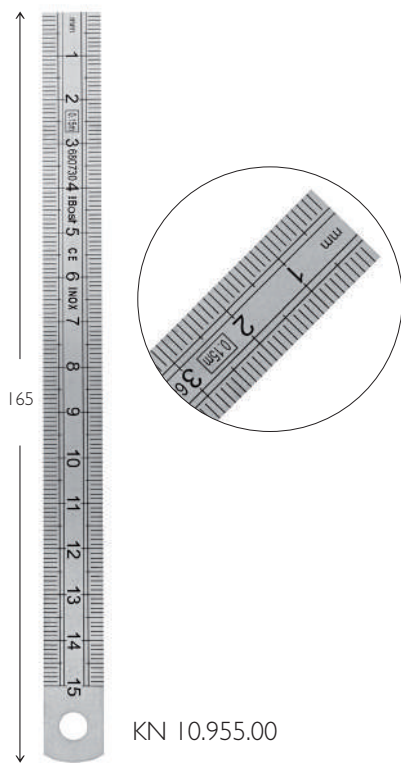

KN 10.955.00

RIGHELLO

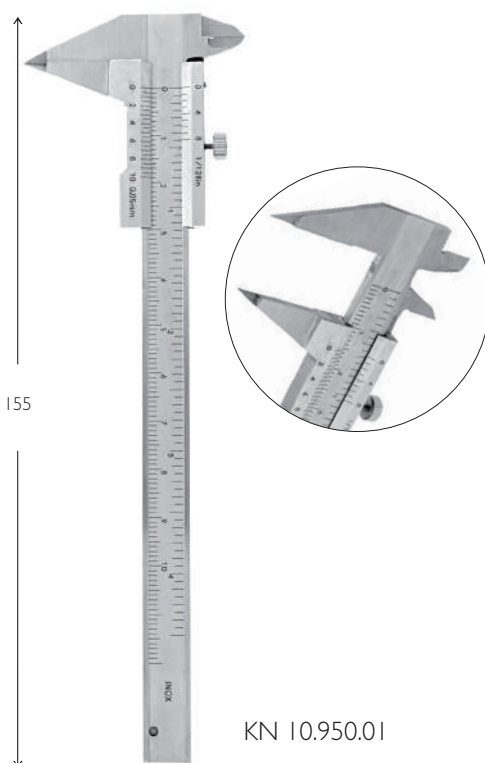

KN 10.950.01

CALIBRO MANUALE

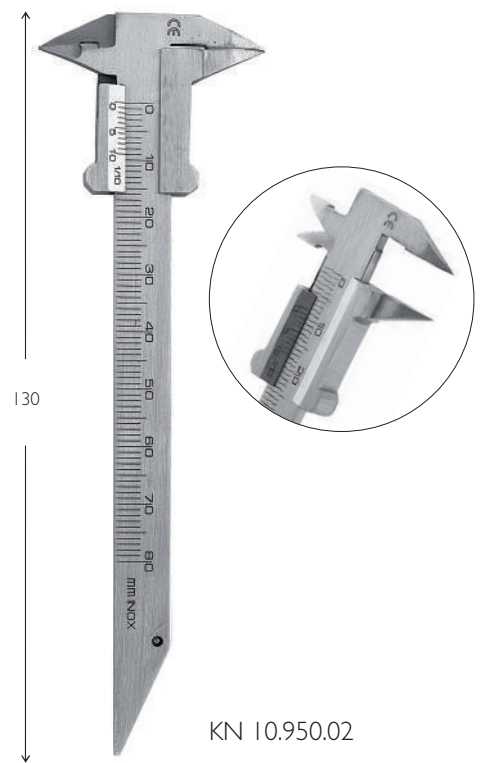

KN 10.950.02



Pinze emostatiche

Strumentario

Koine

Haemostatic forceps

Arterienklemmen

Pinzas hemostaticas



KN 13.028.10



KN 13.029.10

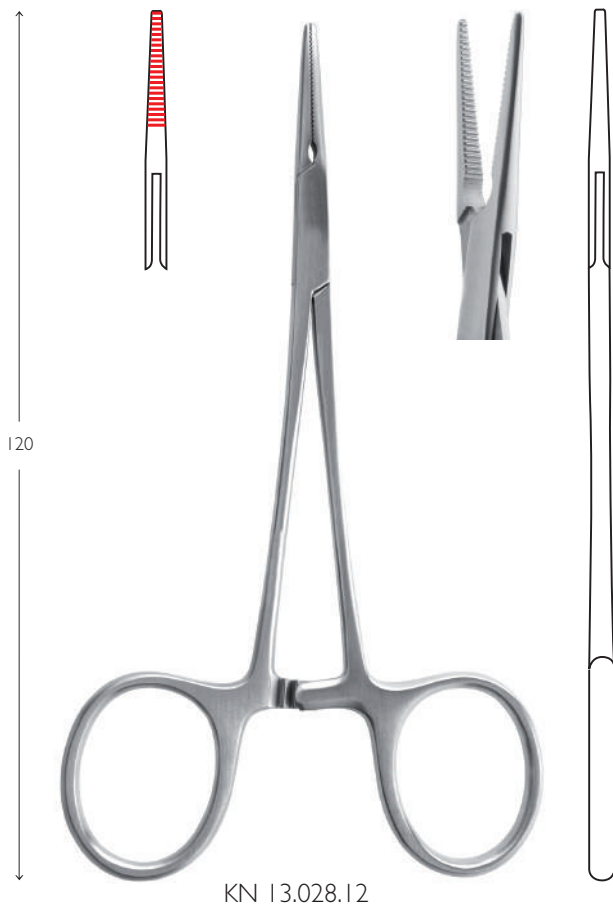

KN 13.028.12

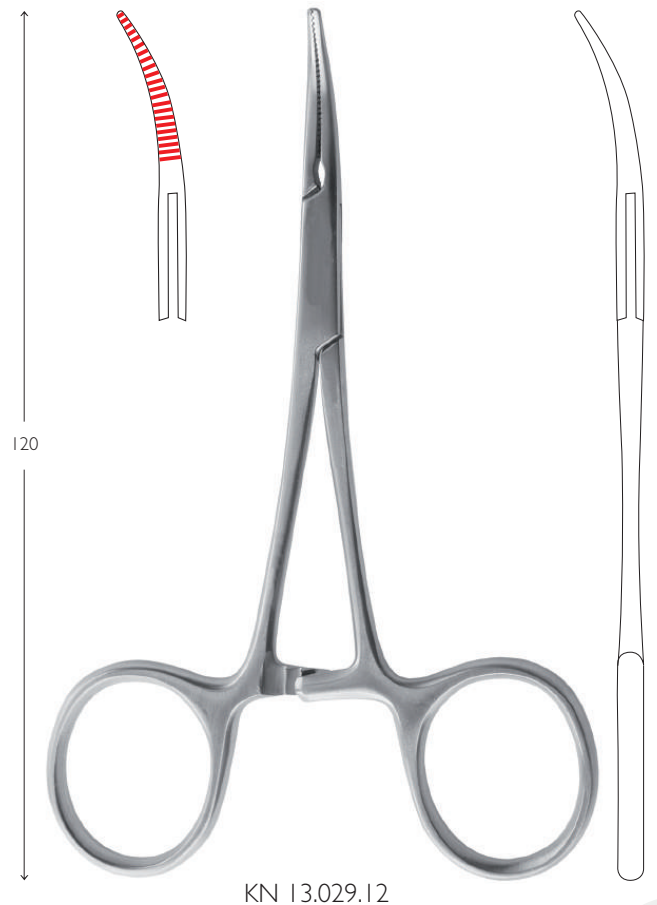

KN 13.029.12

Pinze emostatiche

Strumentario



Haemostatic forceps

Arterienklemmen

Pinzas hemostaticas



KN 13.042.10

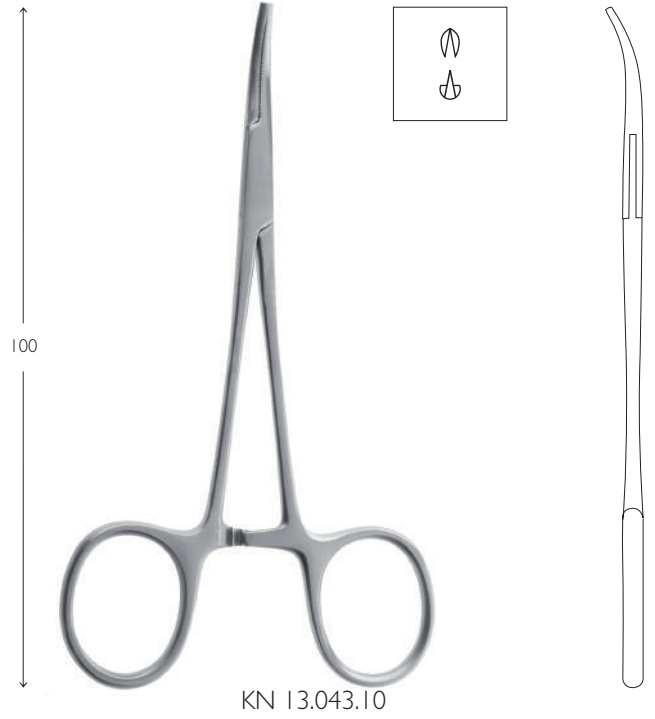

KN 13.043.10



KN 13.042.12



KN 13.043.12





Strumenti utilità

Strumentario



Utility tools



Hilfsprogramme



Herramientas de utilidad

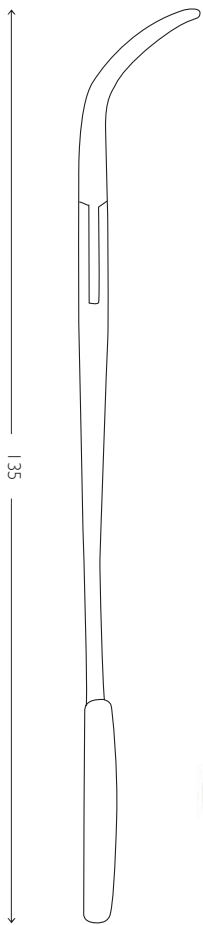

135

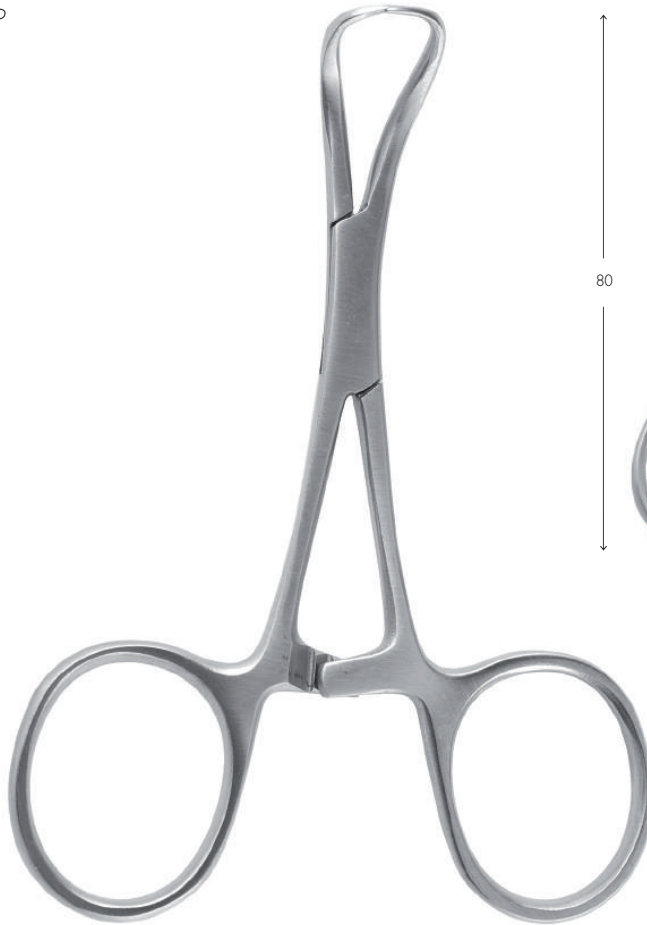

80

KN 17.251.08

KN 17.251.13 **Backaus** - Pinza per teli

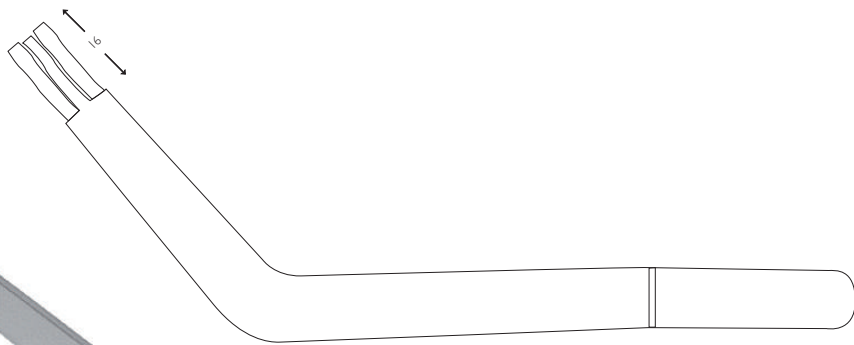

6

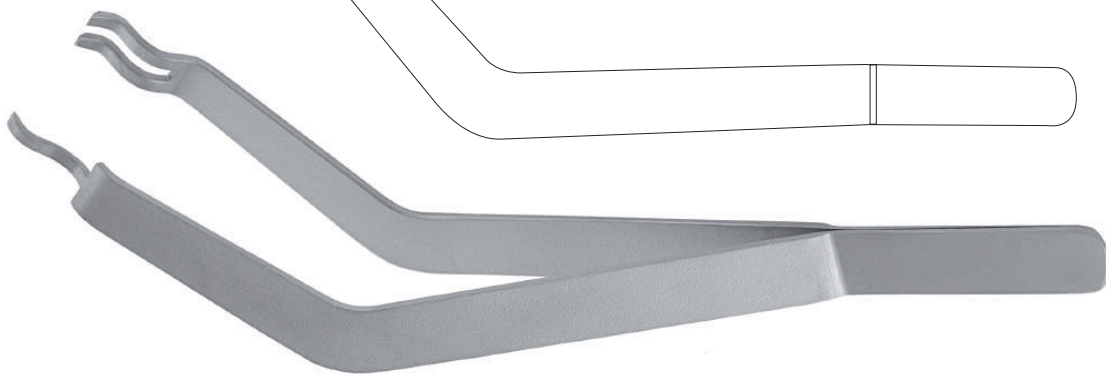

160

KN 17.793.20 - Pinza Prendi Strumenti





Porta aghi

Strumentario



Needle holders



Nadelhalter



Porta agujas

Baum Gartner

KN 19.120.14

140

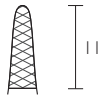

11

Crile-Wood

KN 19.136.15

150

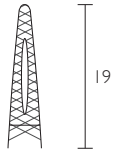

19

Mayo-Hegar

KN 19.170.14

140

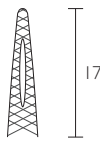

17

Mayo-Hegar

KN 19.170.16

160

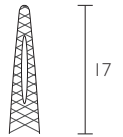

17



Porta aghi

Strumentario



Needle holders



Nadelhalter



Porta agujas

180

Mayo-Hegar

KN 19.170.18

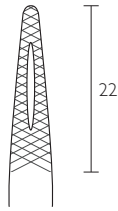

140

Mathieu

KN 19.300.14

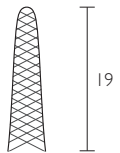

170

Mathieu
punta fine

KN 19.300.17

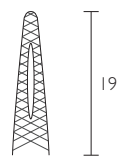

140

Mathieu

KN 19.301.14

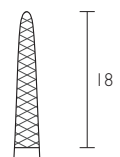



Porta aghi

Strumentario



Needle holders



Nadelhalter



Porta agujas



Boynton

KN 19.310.12

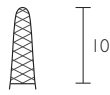

Arruga

KN 19.320.16

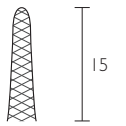

Olsen-Hegar

KN 19.380.14

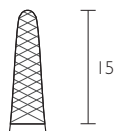

Gillies

KN 19.385.16

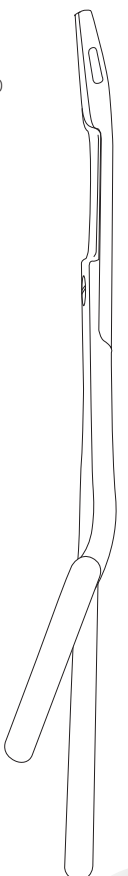
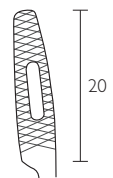



Porta aghi

Strumentario



Needle holders



Nadelhalter



Porta agujas

Castroviejo diritto

KN 19.824.14

140

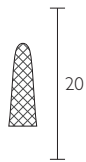
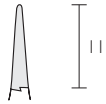

Castroviejo curvo

KN 19.825.14

140

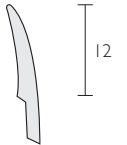

Porta aghi TC

Strumentario



Needle holder TC

Nadelhalter TC

Porta agujas TC

Derf

KN 20.120.12



120



Crile-Wood

KN 20.164.15

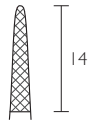

150



Crile-Wood

KN 20.164.18

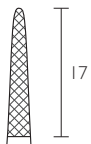

180



Mayo-Hegar

KN 20.220.14

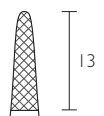

140



Porta aghi TC

Strumentario

Koine

Needle holder TC

Nadelhalter TC

Porta agujas TC

Mayo-Hegar

KN 20.220.16

160

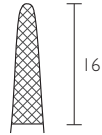

Olsen-Hegar

KN 20.380.14

140

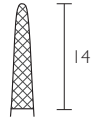

Gillies

KN 20.385.16

170

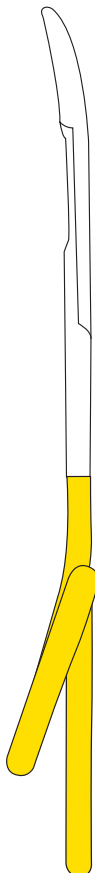
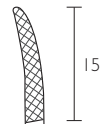

Lichtenberg

KN 20.470.17

170

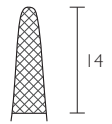

Porta aghi TC

Strumentario

Koine

Needle holder TC

Nadelhalter TC

Porta agujas TC

MATHIEU
Standard

KN 20.420.14

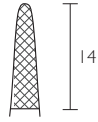

MATHIEU
Standard

KN 20.420.17

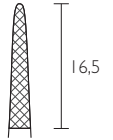

Mathieu
punta fine

KN 20.424.17

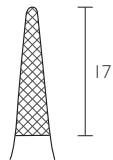

Mathieu
punta fine

KN 20.424.14

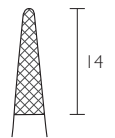

Porta aghi TC

Needle holder TC

Nadelhalter TC

Porta agujas TC

Strumentario

Koine

Castroviejo

KN 20.680.14

140



KN 20.681.14

140



KN 20.680.18

180

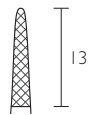

KN 20.681.18

180





- Divaricatori
- Retractors
- Wundhaken
- Separadores



KN 24.033.03 • KN 24.033.02 • KN 24.031.03 • KN 24.031.02 • KN 24.021.03 • KN 24.021.02 • KN 24.023.03 • KN 24.023.02

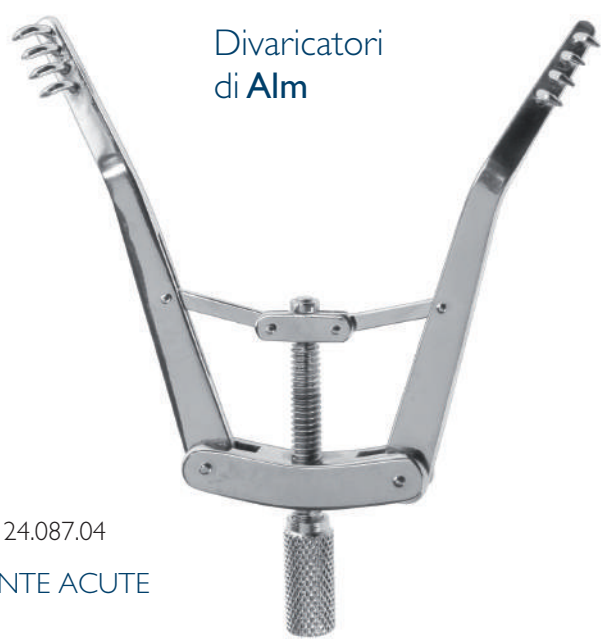

Divaricatori di Alm

KN 24.087.04
PUNTE ACUTE



KN 24.088.04
PUNTE SMUSSE



- Divaricatori
- Retractors
- Wundhaken
- Separadores

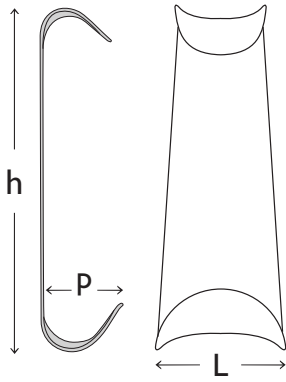

KN 24.301.03
p mm. 35/30
Lmm. 45/30
h mm. 170

KN 24.301.02
p mm. 35/27
Lmm. 35/25
h mm. 150

KN 24.301.01
p mm. 30/25
Lmm. 30/20
h mm. 137



KN 24.260.20
Lmm. 15/18
h mm. 192



KN 24.100.00
(foto 1/1)

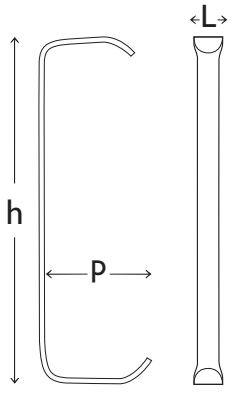
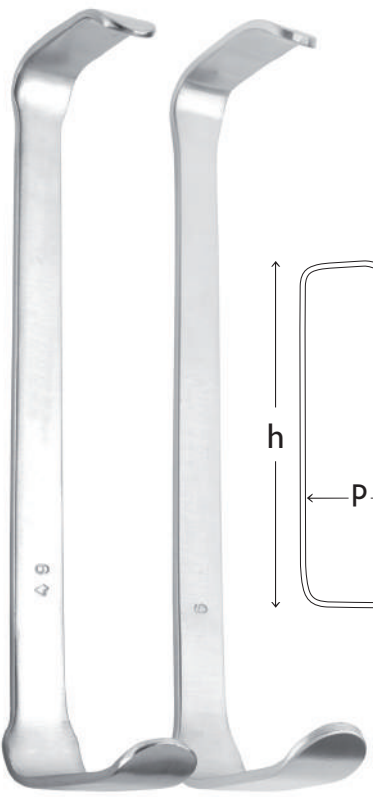

KN 24.100.01
p mm. 40/30
Lmm. 13
h mm. 120

KN 24.100.02
p mm. 38/30
Lmm. 13
h mm. 120

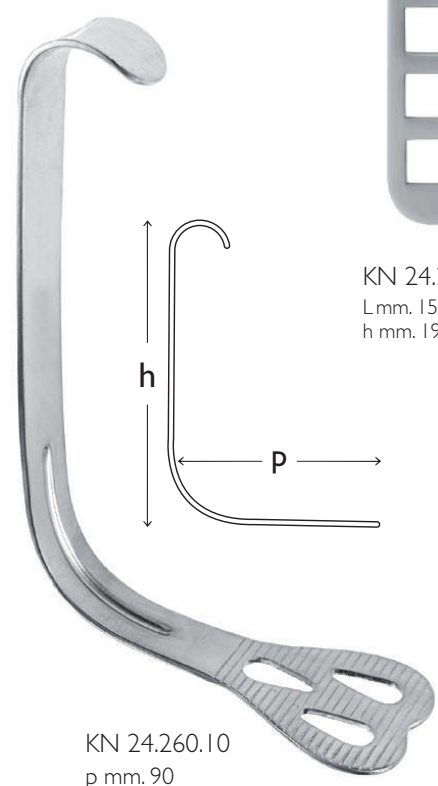

KN 24.260.10
p mm. 90
h mm. 135



KN 24.157.15
mm. 145 x 20

- Divaricatori
- Retractors
- Wundhaken
- Separadores

Divaricatore Anteriore e Posteriore



KN 24.320.01

Divaricatore Occlusale Piccolo



KN 24.320.02

- Divaricatori
- Retractors
- Wundhaken
- Separadores

220



KN 24.180.55
mm 72 x 11



KN 24.038.72
mm 72 x 11



KN 24.185.00
mm 33 x 20



KN 24.161.01
mm 15 x 15 x 22



KN 24.161.02
mm 20 x 22

Divaricatori flessibili - Spatole Malleabili

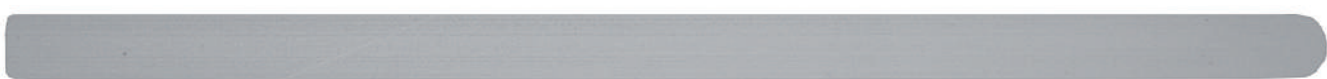

10 mm

KN 24.302.01



15 mm

KN 24.302.02



20 mm

KN 24.302.03

200

- Divaricatori
- Retractors
- Wundhaken
- Separadores

220



KN24 169 55
mm 55 x 11



KN 24.169.25
mm 28 x 7



KN 24.169.45
mm 42 x 10



KN 24.169.35
mm 35 x 11



KN 24.056.55
mm 55 x 11



KN 24.170.28
mm 21,5 x 30 x 11



KN 24.170.40
mm 21 x 40 x 14

- Divaricatori
- Retractors
- Wundhaken
- Separadores

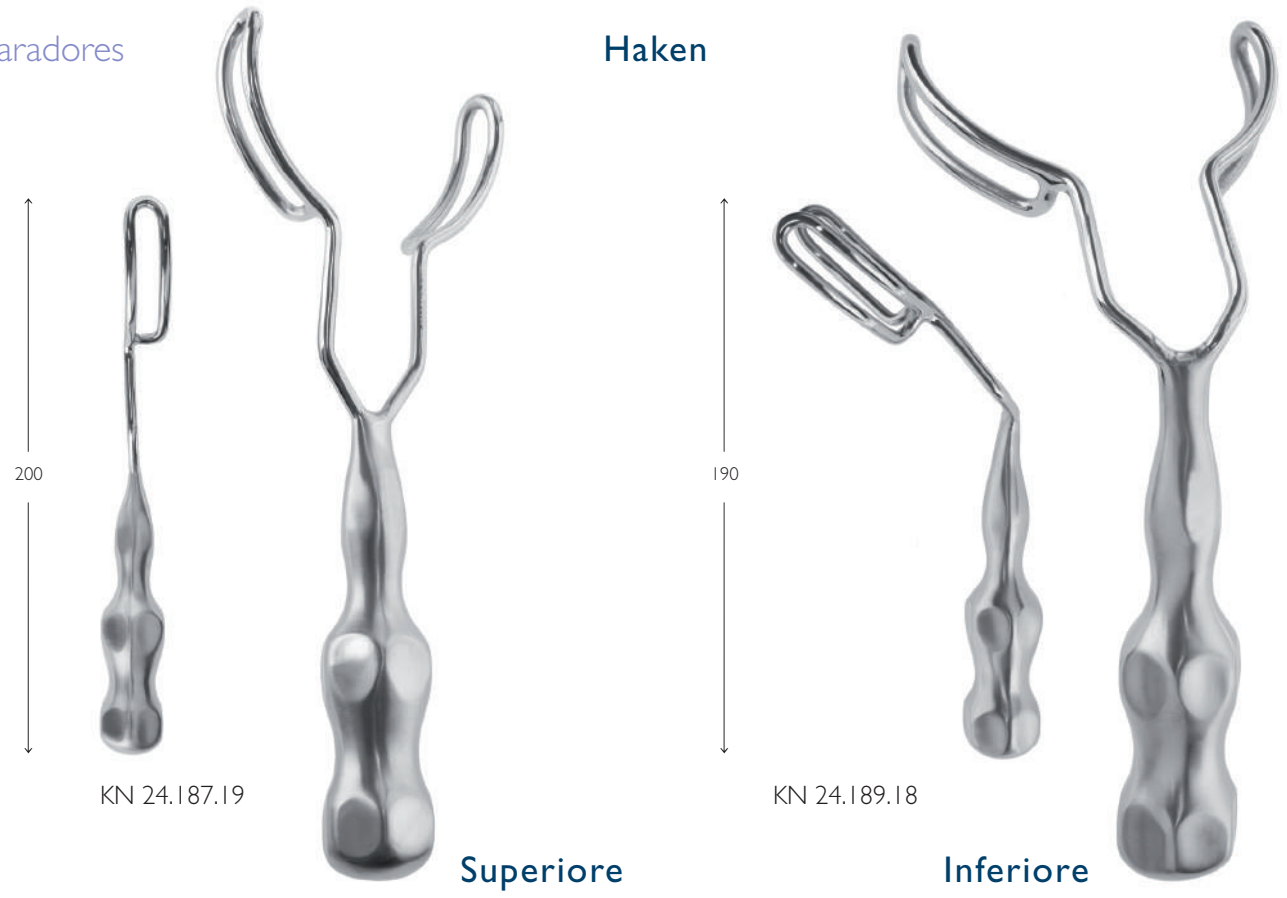

Stemberg singoli e doppi





Scollaperiostei

Strumentario

Koine

Periosteals

Décolleurs

Periostotomo

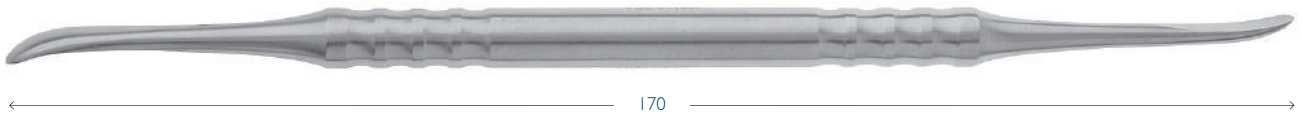

MOLT FIG.1 KN 27.721.01

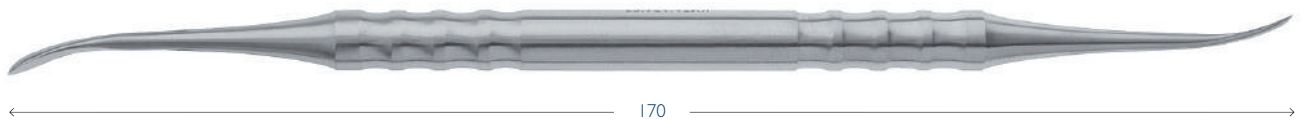

MOLT FIG.2 KN 27.721.02



MOLT FIG.3 KN 27.721.03

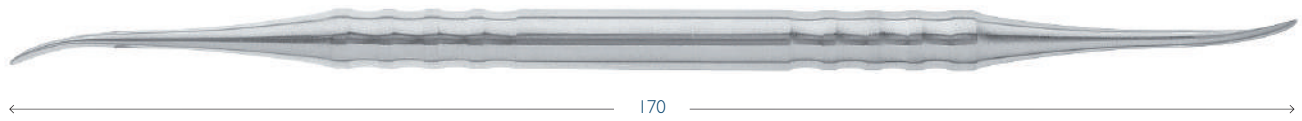

FREER KN 27.451.18

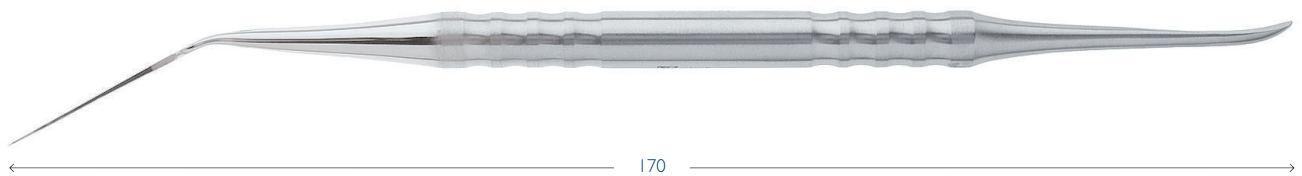

PRICHARD KN 27.425.00

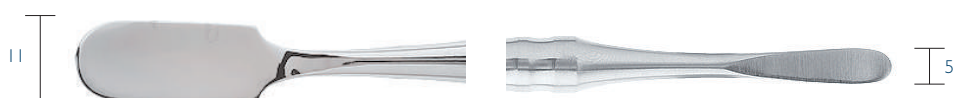

Scollaperiostei

Strumentario

Koine

Periosteals

Décolleurs

Periostotomo

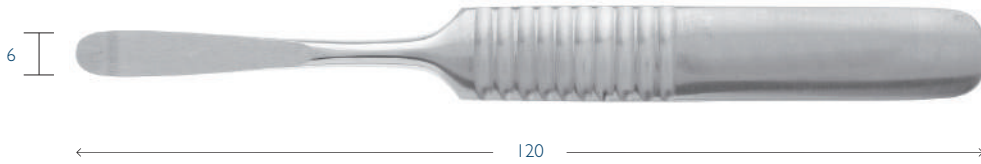

WILLINGER KN 27.741.13

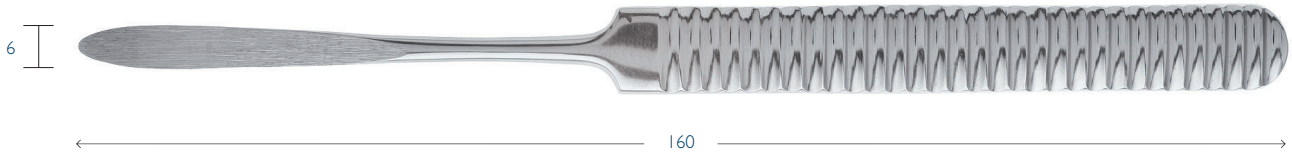

KN 27.741.16

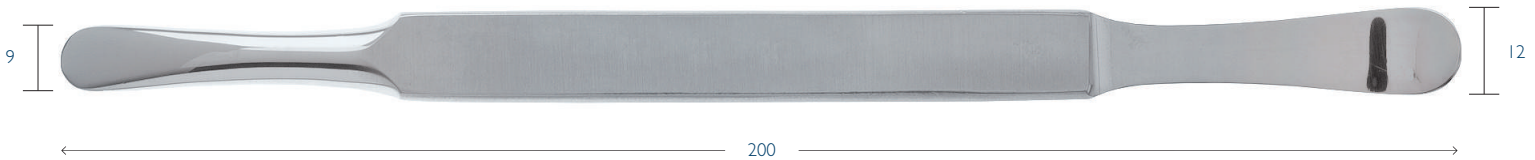

SELDIN KN 27.467.19



Scollaperiostei

Strumentario

Koine

Periosteals

Décolleurs

Periostotomo

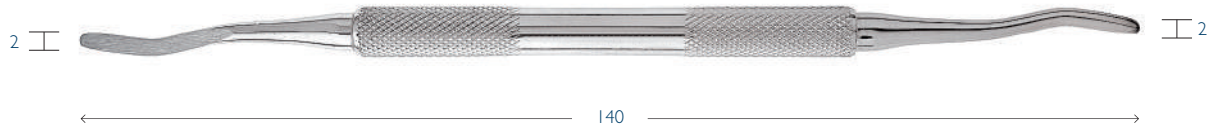

HOPKINS KN 27.722.01

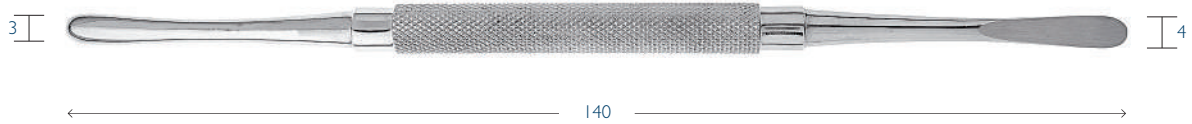

MEAD KN 27.719.00

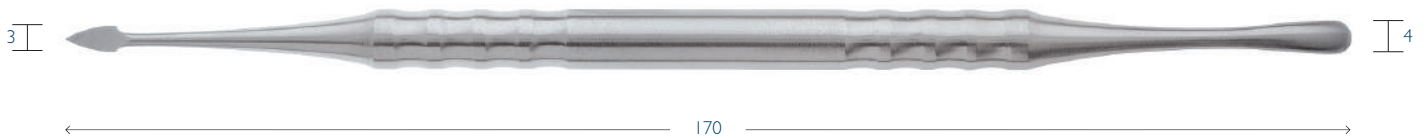

BUSER KN 27.720.00

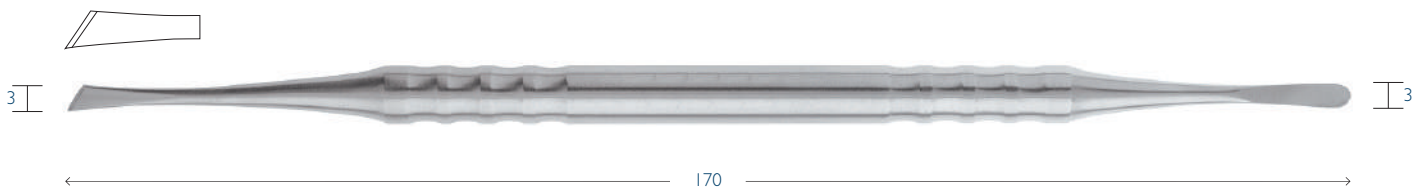
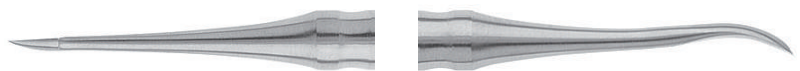

WEST-GLICMAN KN 27.424.00



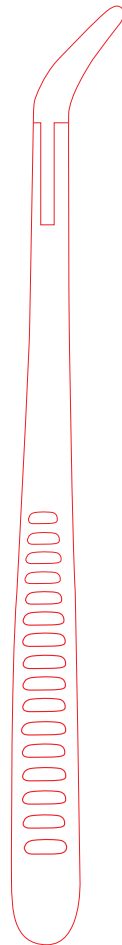

Pinze ossivore

Strumentario

Koine

Bone rongeur forceps

Hohlmeißelzange

Pinzas gubias

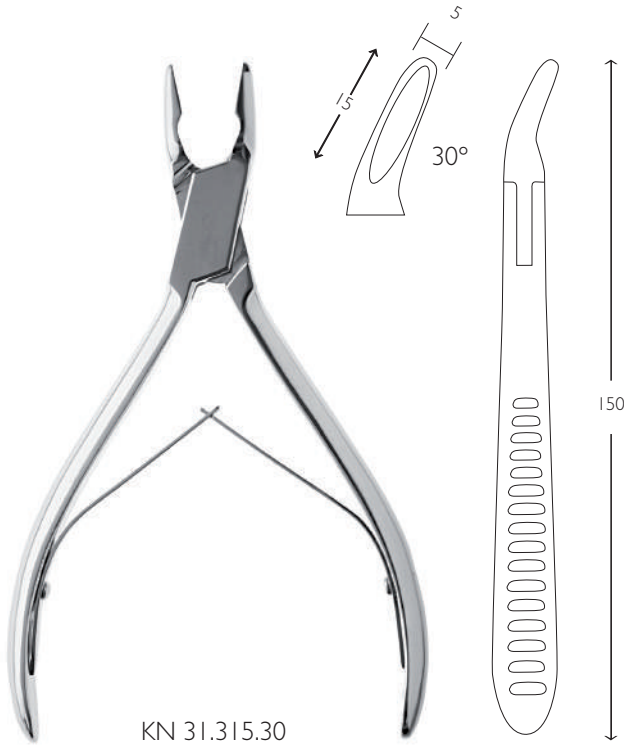

KN 31.315.30

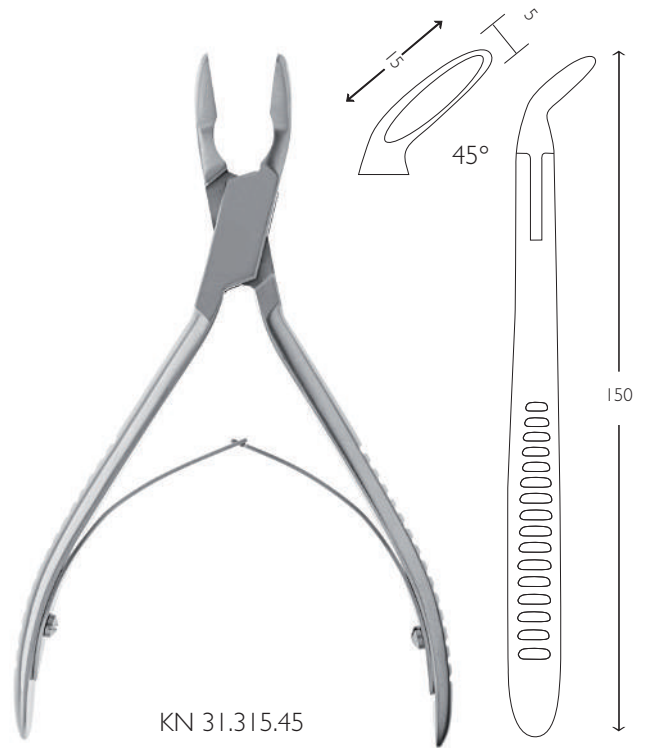

KN 31.315.45

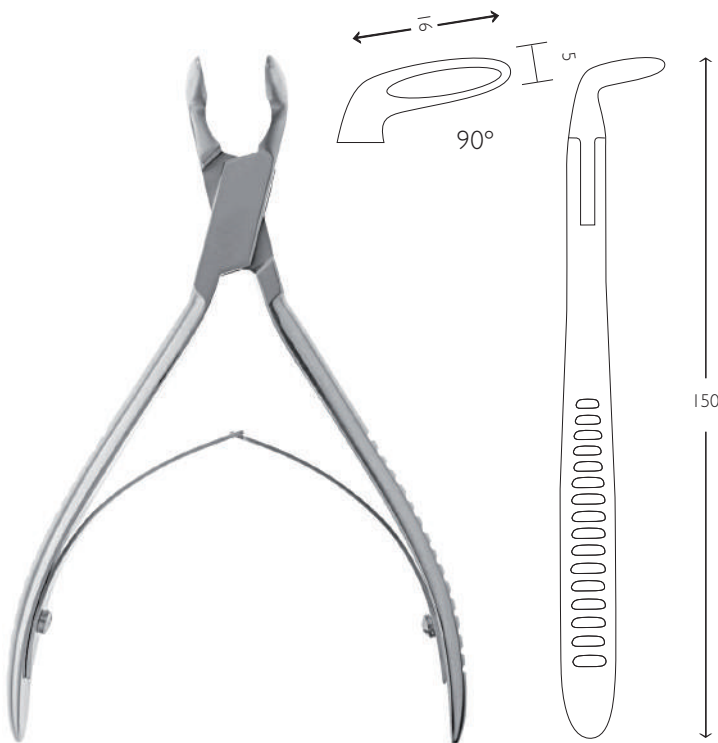

KN 31.315.90

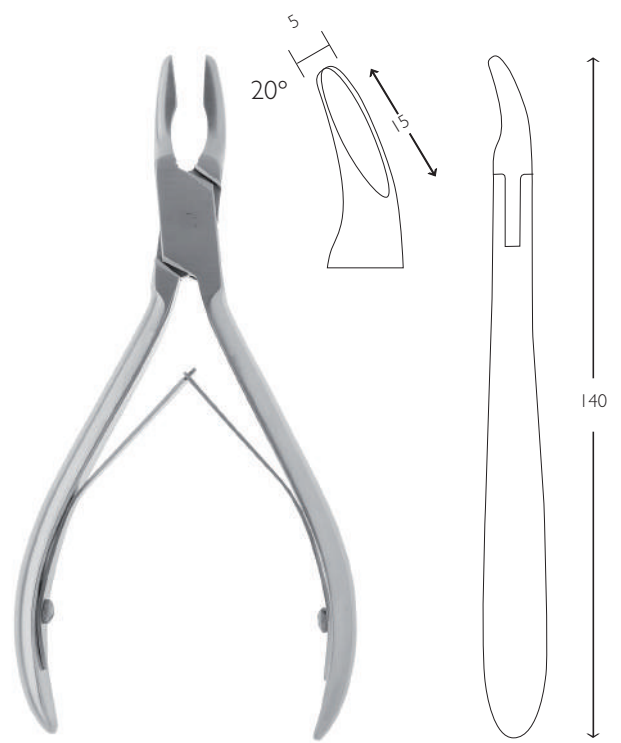

KN 31.321.14

Pinze ossivore

Strumentario

Koine

Bone rongeur forceps

Hohlmeißelzange

Pinzas gubias

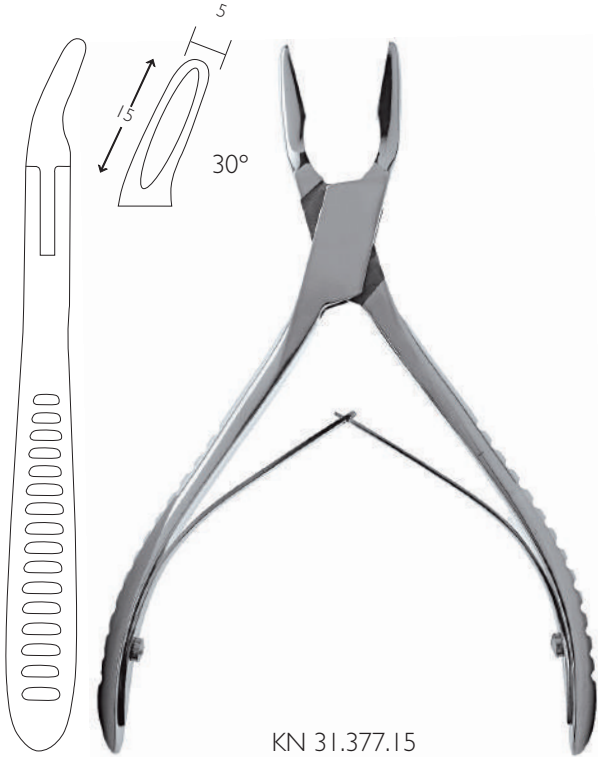

KN 31.377.15

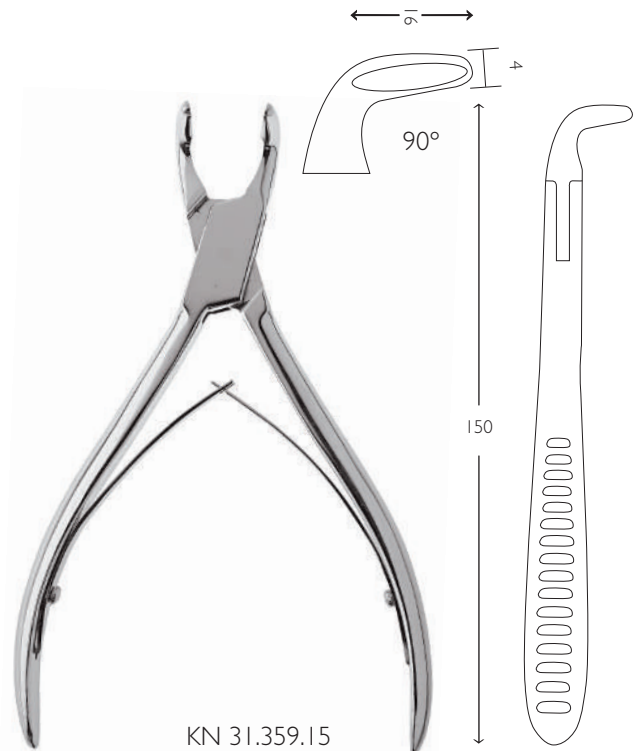

KN 31.359.15

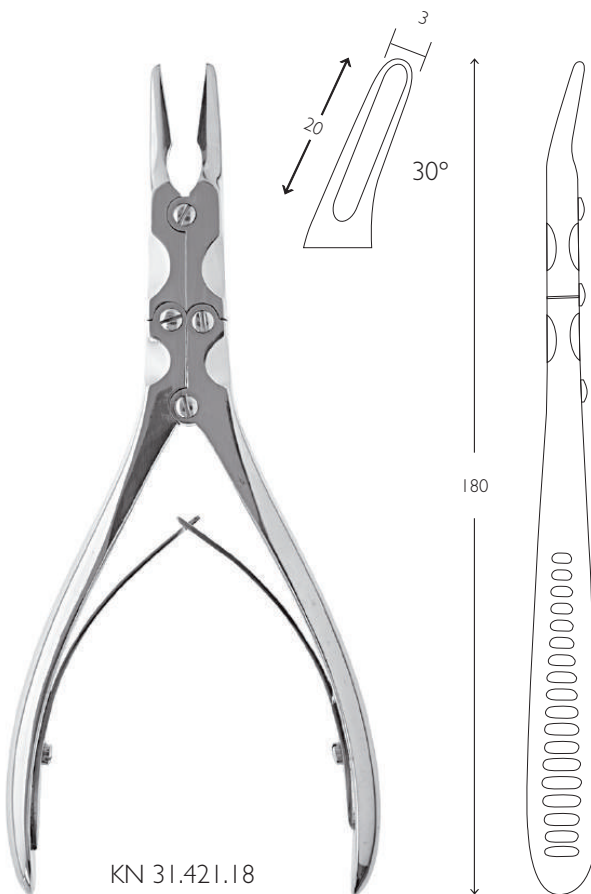

KN 31.421.18

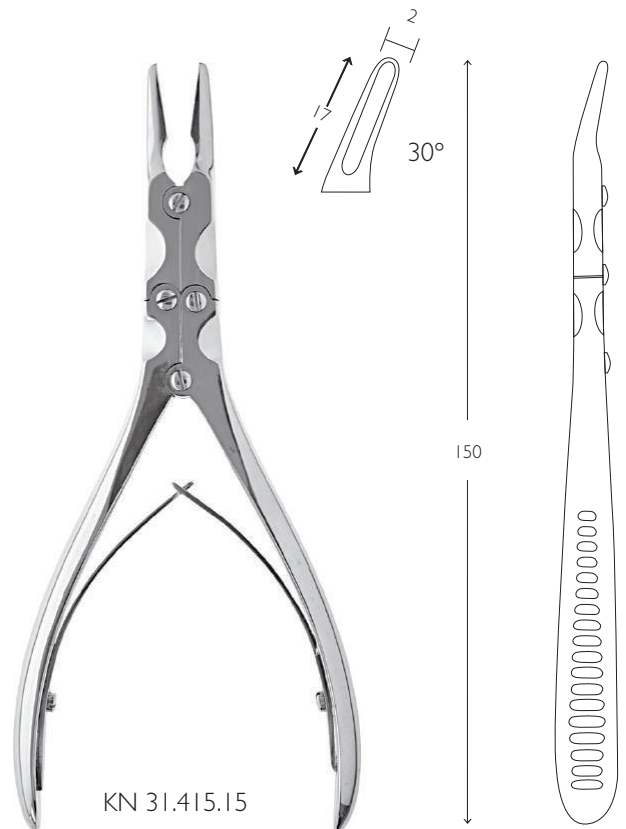
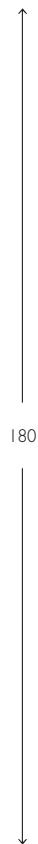

KN 31.415.15



Pinze ossivore

Bone rongeur forceps

Hohlmeißelzange

Pinzas gubias

Strumentario

Koine

MINI FRIEDMAN DELICAT

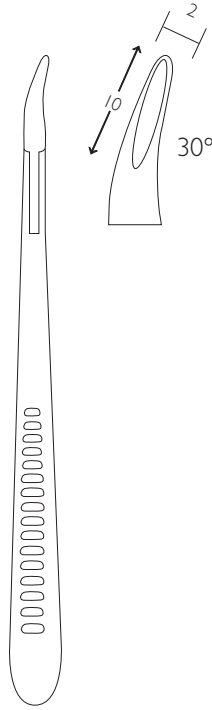
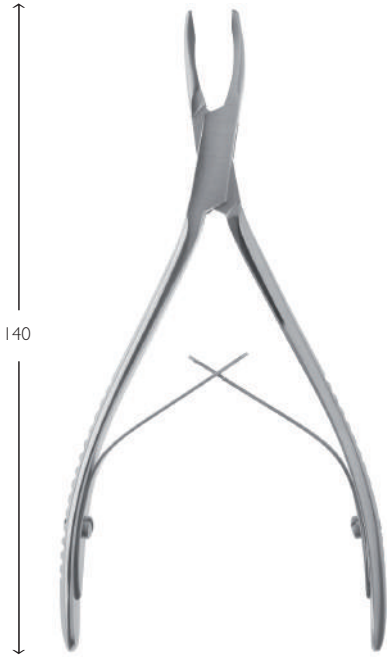

KN 31.451.30

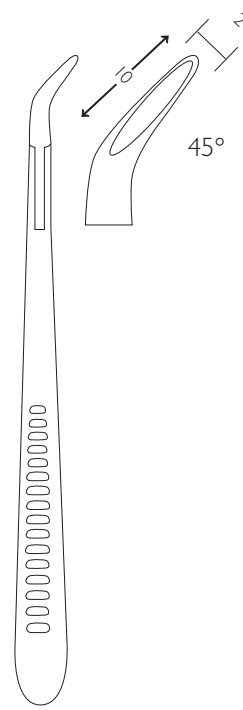

KN 31.451.45

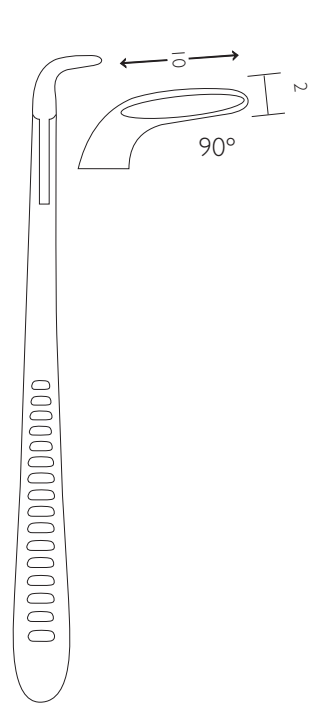

KN 31.451.90

32

38

Mucotomi - Frese - Cannule



Trephine Drills - Tissue Punches

Trepanbohrer - Schleimhautstanzen

Fresas trephine - Marcadores de Mucosa

Mucotomi



← 15 → ← 17 →

ø 3,5 esterno
 ø 3 interno
 KN 32.200.30

ø 6 esterno
 ø 5 interno
 KN 32.200.50

ø 4,5 esterno
 ø 4 interno
 KN 32.200.40

ø 7 esterno
 ø 6 interno
 KN 32.200.60

ø 5 esterno
 ø 4,5 interno
 KN 32.200.45

ø 9 esterno
 ø 8 interno
 KN 32.200.80

← 32 →

← 32 →

Frese



← 15 → ← 17 →

ø 3 esterno
 ø 2,5 interno
 KN 32.100.25

ø 5 esterno
 ø 4,5 interno
 KN 32.100.45

ø 3,5 esterno
 ø 3 interno
 KN 32.100.30

ø 6 esterno
 ø 5 interno
 KN 32.100.50

ø 4 esterno
 ø 3,5 interno
 KN 32.100.35

ø 9 esterno
 ø 8 interno
 KN 32.100.80

← 32 →

← 32 →

- Cannule
- Cannulas
- Kanülen
- Canulas

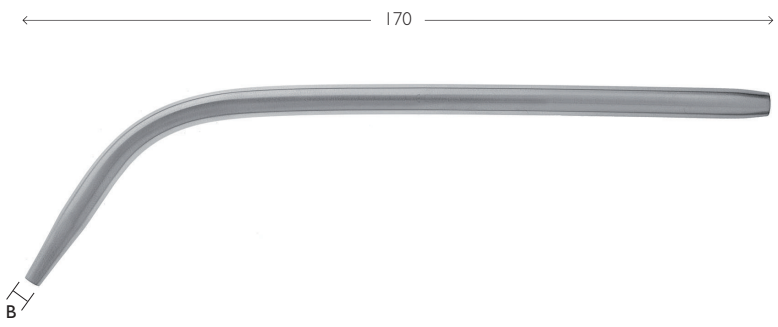

- ⓑ ∅ 3 mm KN 38.517.03
- ∅ 4 mm KN 38.517.04
- ∅ 6 mm KN 38.517.05

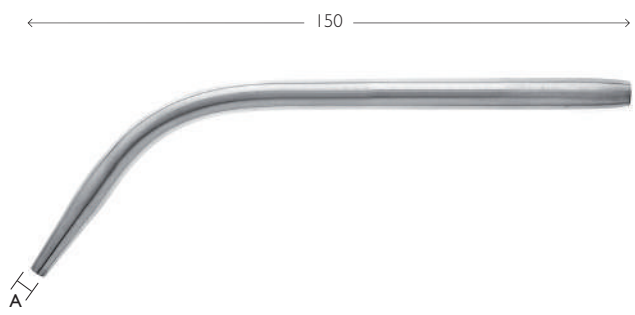

- Ⓐ ∅ 3 mm KN 38.515.03
- ∅ 4 mm KN 38.515.04
- ∅ 6 mm KN 38.515.05

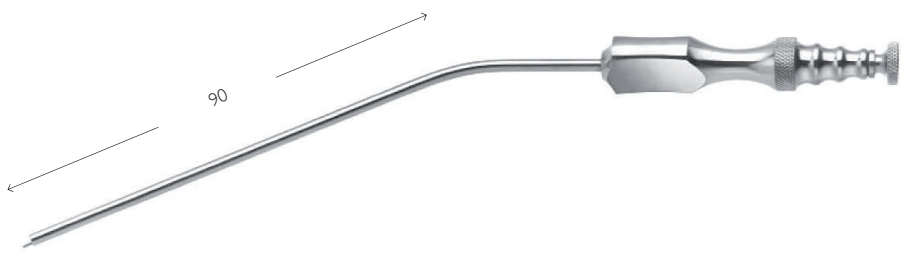

- ∅ 3 mm KN 38.614.03
- ∅ 4 mm KN 38.614.04
- ∅ 6 mm KN 38.614.05

- ∅ 3 mm KN 38.618.03
- ∅ 4 mm KN 38.618.04
- ∅ 6 mm KN 38.618.05



- Scalpelli
- Bonechisels
- Flachmeißel
- Cinceles

Partsch

← 140 →



KN 67.510.03

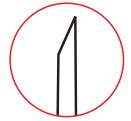

KN 67.510.04

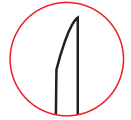

KN 67.510.05



← 170 →



KN 67.514.03

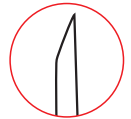

KN 67.514.04



KN 67.514.05



Mini Lambotte

← 130 →



KN 67.554.04

4



KN 67.554.06

6

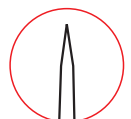

KN 67.554.08

8



Sgorbie

Strumentario



Bonechisels



Flachmeißel



Cinceles

← 140 →



KN 67.512.03



KN 67.512.04



KN 67.512.05



← 170 →



KN 67.516.03



KN 67.516.04



KN 67.516.05



Raspe per osso

Strumentario



Bone files

Knochen feilen

Linaste huesos

Miller

KN 67.180.01

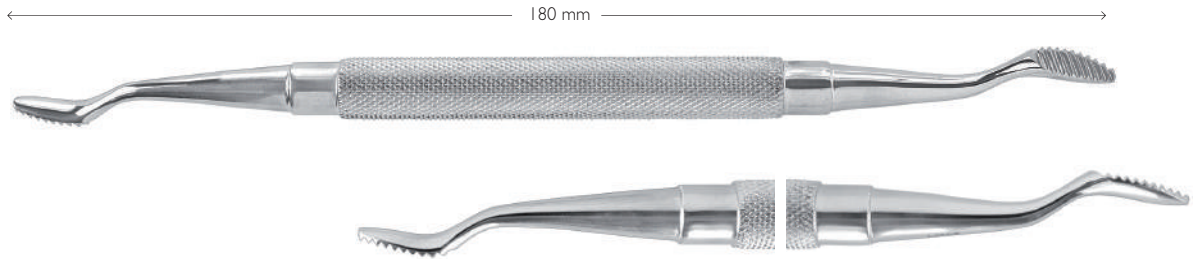

Miller

KN 67.180.02

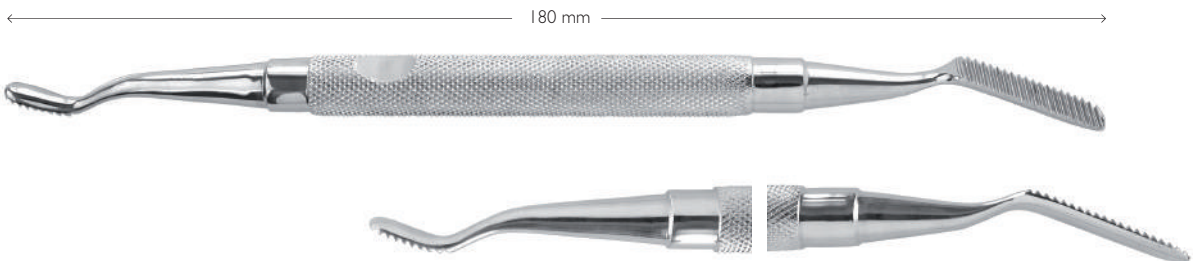

Miller

KN 67.180.03

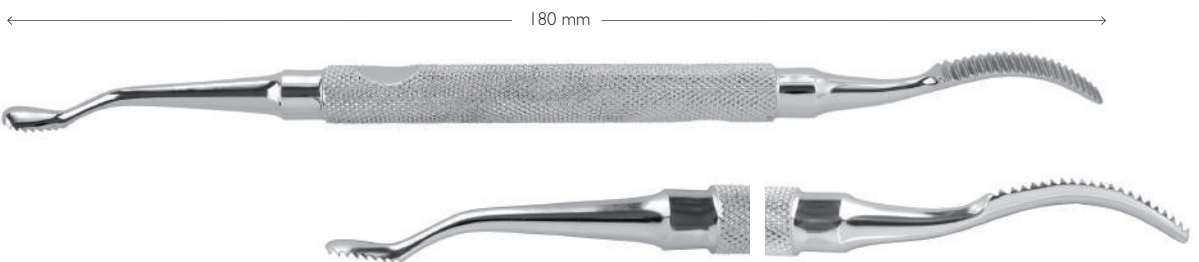

Scalpell

Strumentario



Bonechisels

Flachmeißel

Cinceles

Graduati dritti
doppio bisello

Graduati curvi
doppio bisello

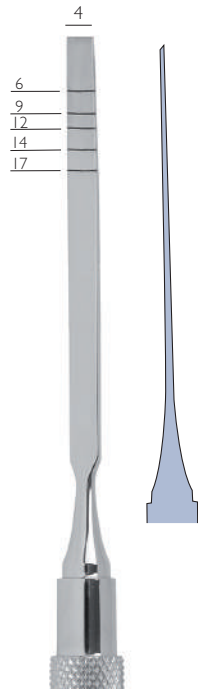

KN 67.401.04

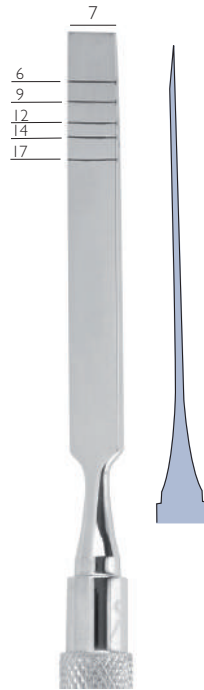

KN 67.401.07

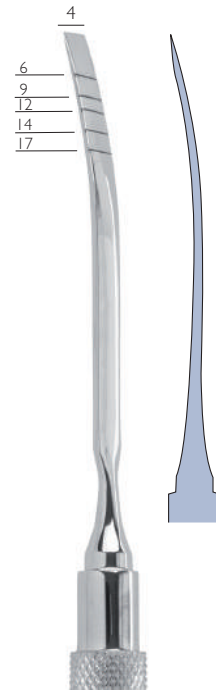

KN 67.402.04

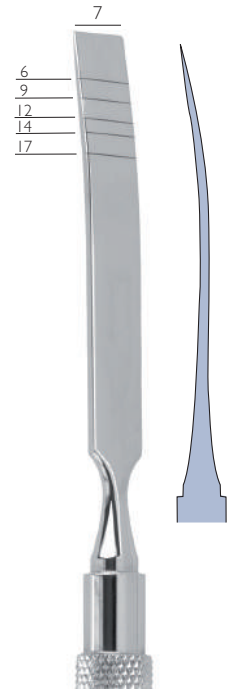

KN 67.402.07

Scalpell per osso

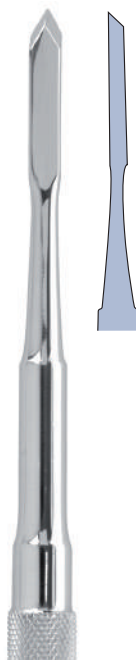

KN 67.520.00

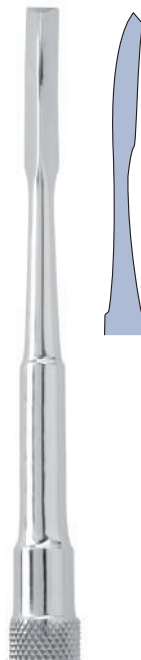

KN 67.520.01



KN 67.520.02



KN 67.520.03

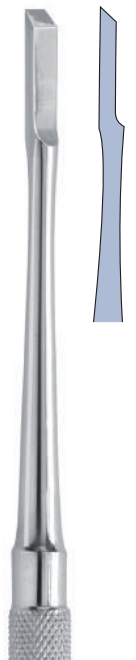

KN 67.520.04

Martelli

Strumentario

Koine

Mallets

Hämmer

Martillos

← 190 →



KN 67.642.17

← 170 →

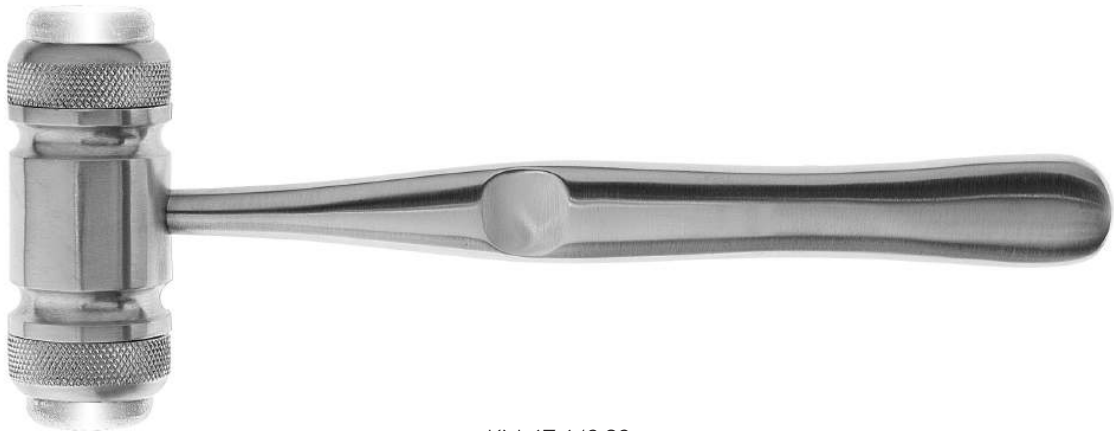

KN 67.642.32

← 170 →



KN 67.642.33

Compattatori per osso

Strumentario

Koine

Compactors bone

Verdichter Knochen

Compactadores de hueso

← 155 →



∅ mm 4

KN 67.691.01



∅ mm 3

← 155 →



∅ mm 8

KN 67.691.02



∅ mm 6



Curette del seno

Strumentario



Sinus lift elevators



Sinus-lift elevatoren



Sinus-lift elevadores

← 170 →



KN 67.685.01



KN 67.685.02



KN 67.685.03



KN 67.690.01



KN 67.694.02



KN 67.696.01



KN 67.696.02



KN 67.696.03

Curette del seno

Strumentario



Sinus lift elevators

Sinus-lift elevatoren

Sinus-lift elevadores

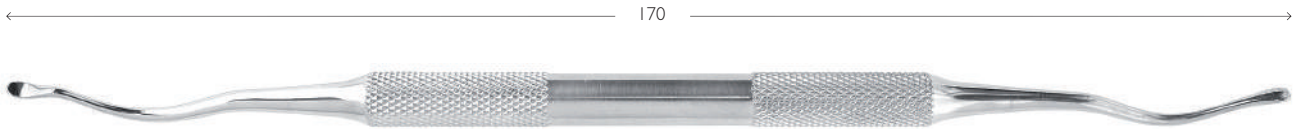

KN 67.695.01

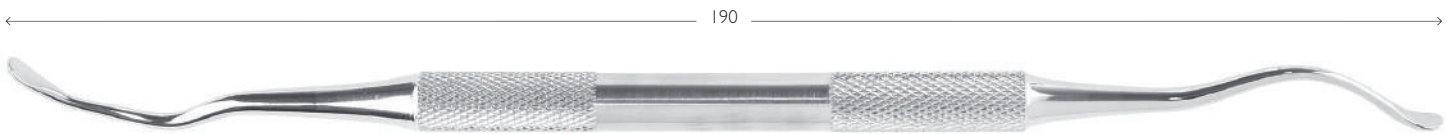

KN 67.695.02



KN 67.695.03



KN 67.695.04



KN 67.695.05



KN 67.695.06

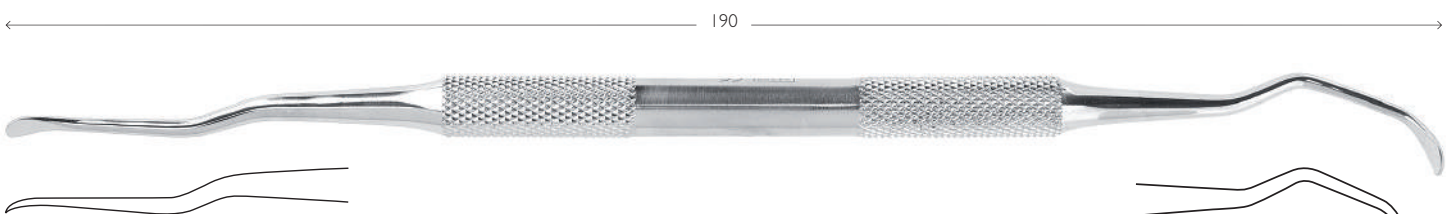

KN 67.695.07

Curette chirurgiche

Strumentario



Boné curette

Scharfe Löffel

Cucharillas cortantes

Lucas

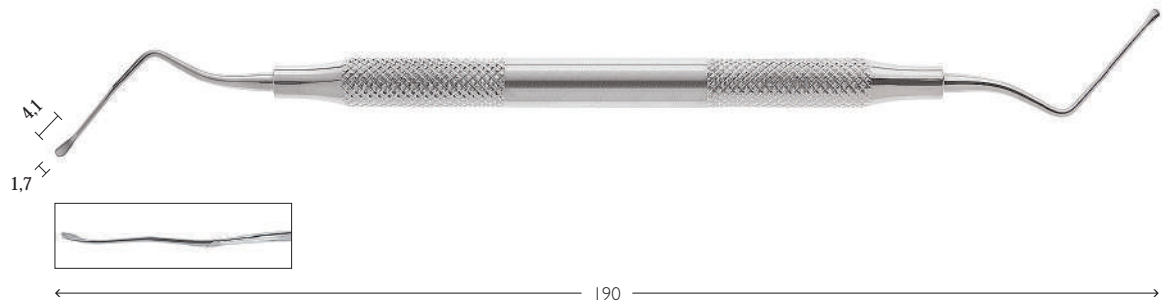

KN 67.797.01

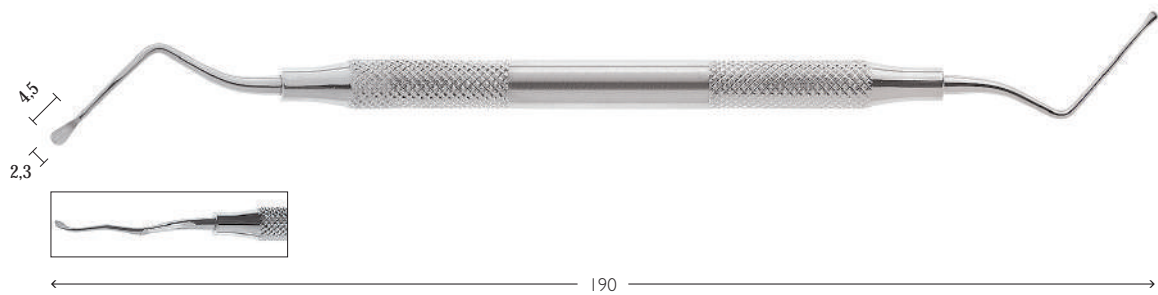

KN 67.797.02

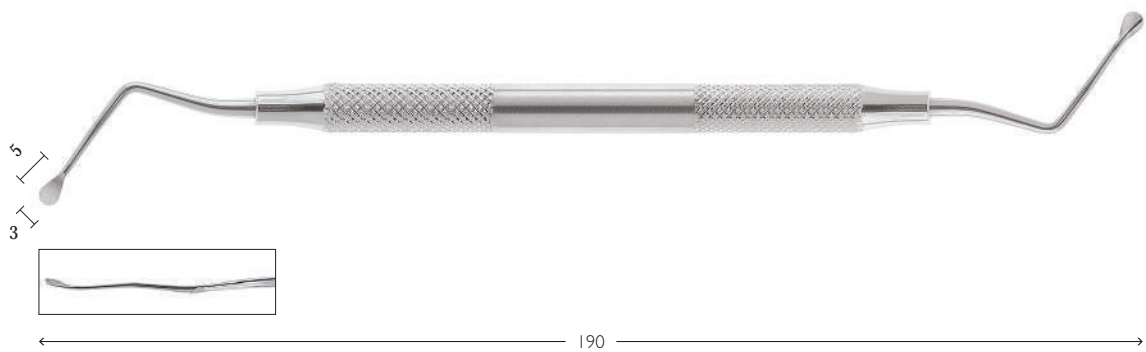

KN 67.797.03

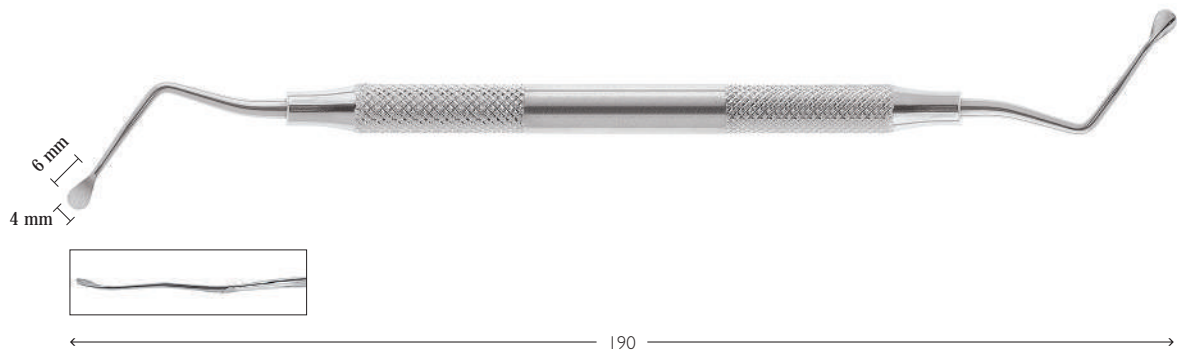

KN 67.797.04

Curette chirurgiche

Strumentario



Boné curette

Scharfe Löffel

Cucharillas cortantes

Cucchiai Hemingway



KN 67.799.01

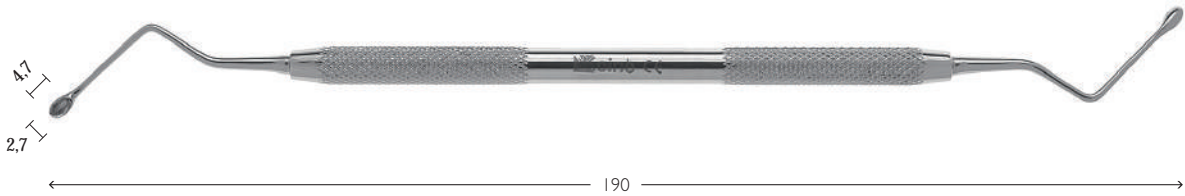

KN 67.799.02

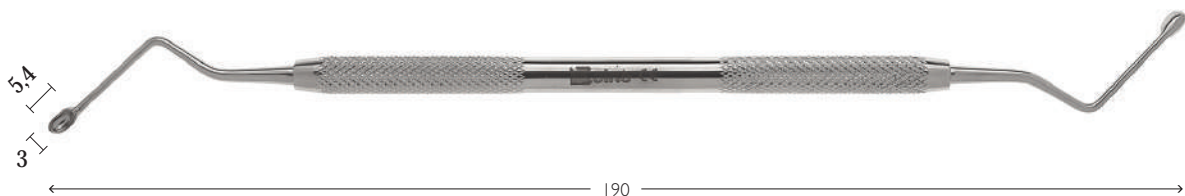

KN 67.799.03

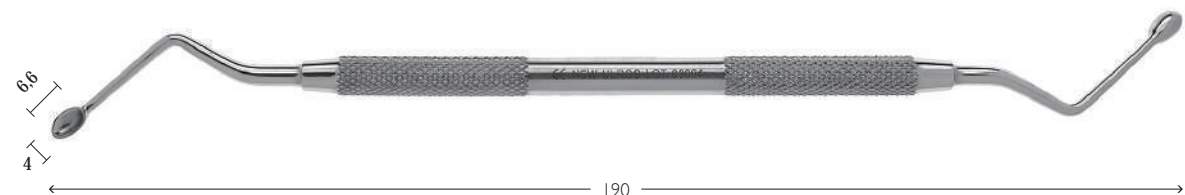

KN 67.799.04

- Osteotomi
- Osteotomes
- Osteotome
- Osteotomos

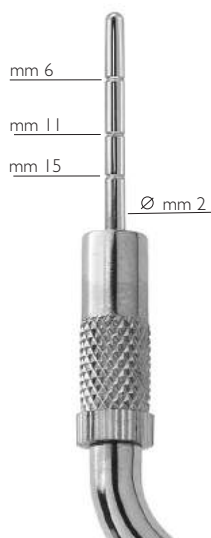
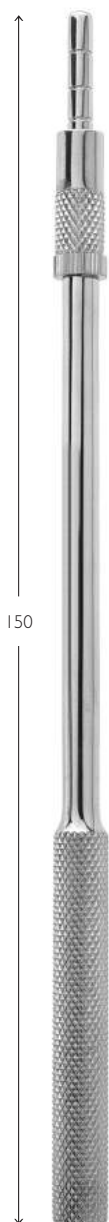
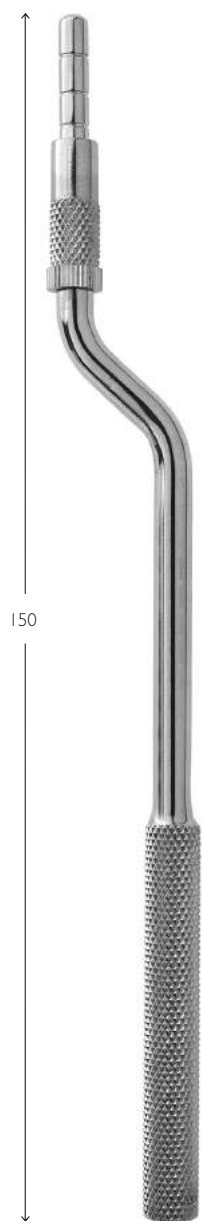

KN 67.851.01



KN 67.851.02



KN 67.851.03

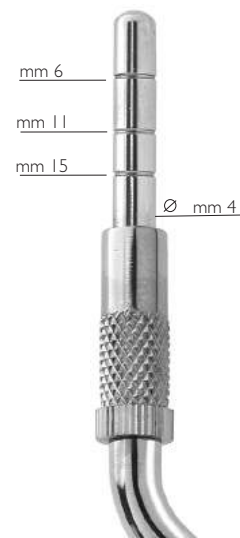

KN 67.851.04

Convessi - diritti con stop



KN 67.850.01



KN 67.850.02



KN 67.850.03



KN 67.850.04



- Osteotomi
- Osteotomes
- Osteotome
- Osteotomos

Concavi - baionetta con stop

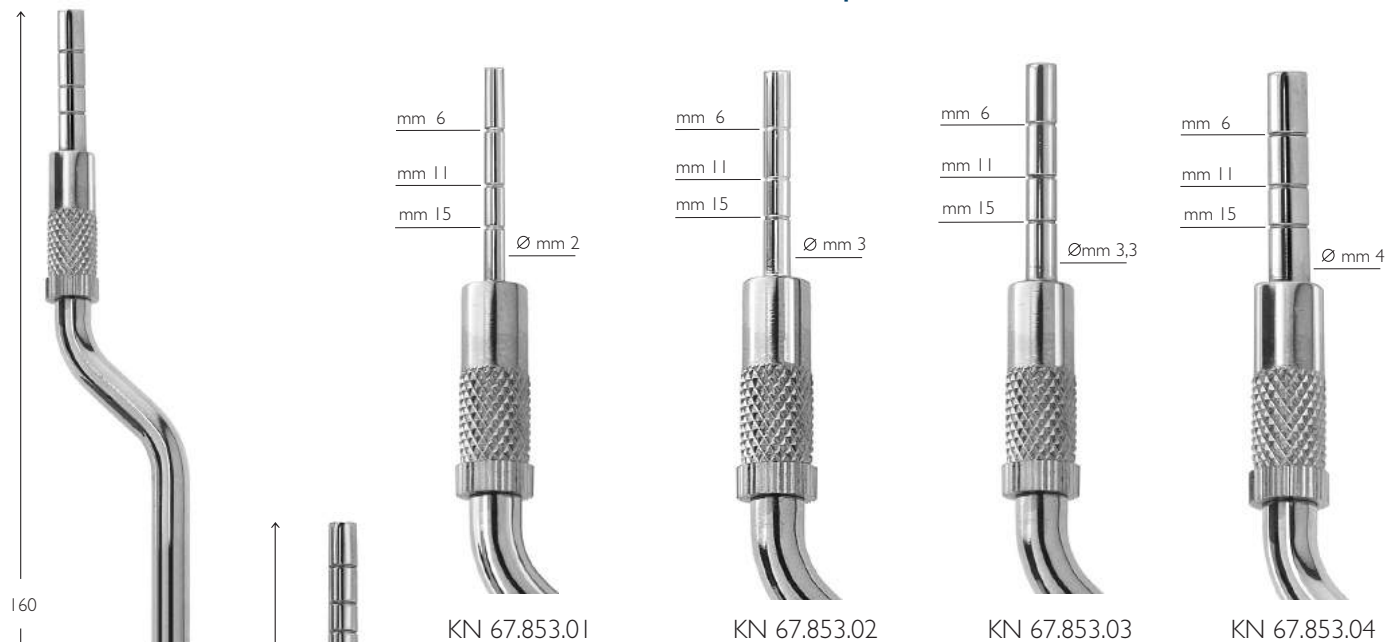

Concavi - diritti con stop

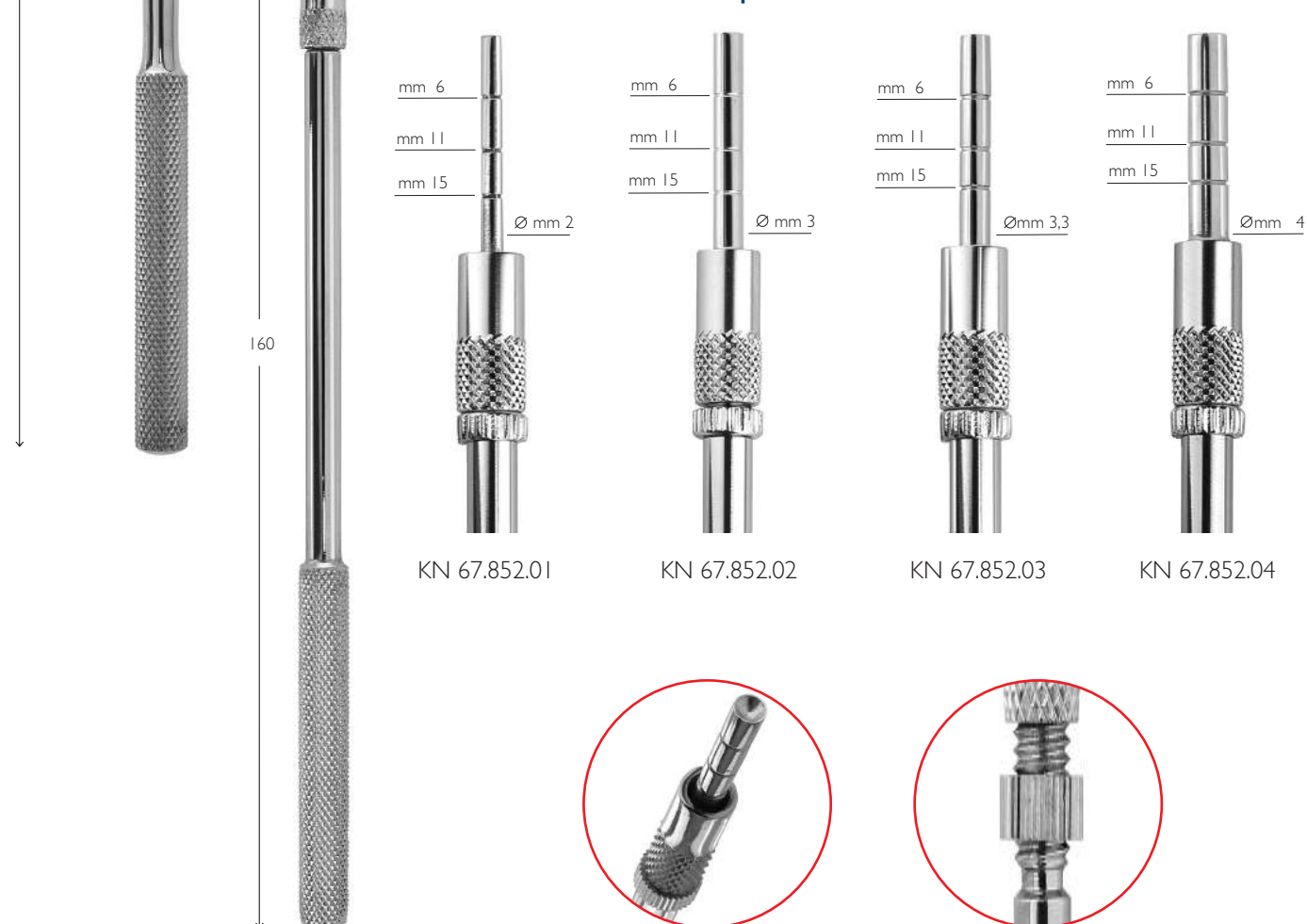

- Osteotomi
- Osteotomes
- Osteotome
- Osteotomos

Dilatatori

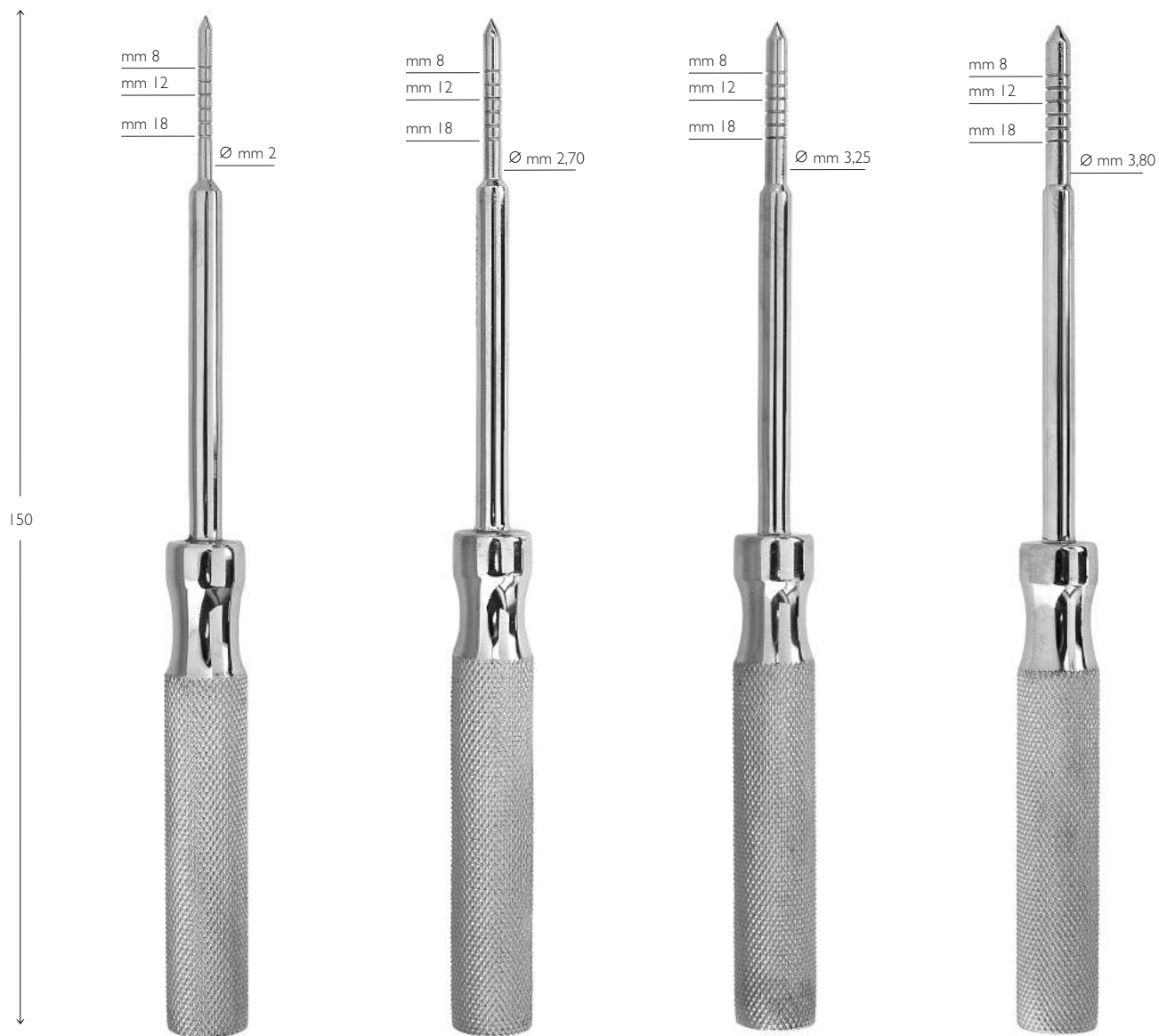

KN 67.860.20

KN 67.860.26

KN 67.860.32

KN 67.860.37

- Osteotomi
- Osteotomes
- Osteotome
- Osteotomos

Sammer



150

	Ø 1,60
mm 7,5	Ø 1,80
mm 10	Ø 2,00
mm 13	Ø 2,40
mm 15,5	Ø 3,60



KN 67.861.01

	Ø 1,90
mm 7,5	Ø 2,20
mm 10	Ø 2,35
mm 13,5	Ø 3,30
mm 13,5	Ø 3,40
mm 25	Ø 4,50



KN 67.861.02

	Ø 2,50
mm 7,5	Ø 3,20
mm 10,5	Ø 3,35
mm 13,5	Ø 3,50
mm 13,5	Ø 3,60
mm 21	Ø 4,40



KN 67.861.03

	Ø 3,10
mm 7,5	Ø 3,70
mm 10,5	Ø 3,90
mm 15,5	Ø 4,30



KN 67.861.04

	Ø 3,90
mm 10	Ø 5,00
mm 13	Ø 5,20
mm 20,5	Ø 6,30



KN 67.861.05

	Ø 5,50
mm 10	Ø 6,20
mm 13	Ø 6,30



KN 67.861.06

Iniettori di osso

Strumentario



Bone Injectors

Injertion von Knochen

Inyector para huese

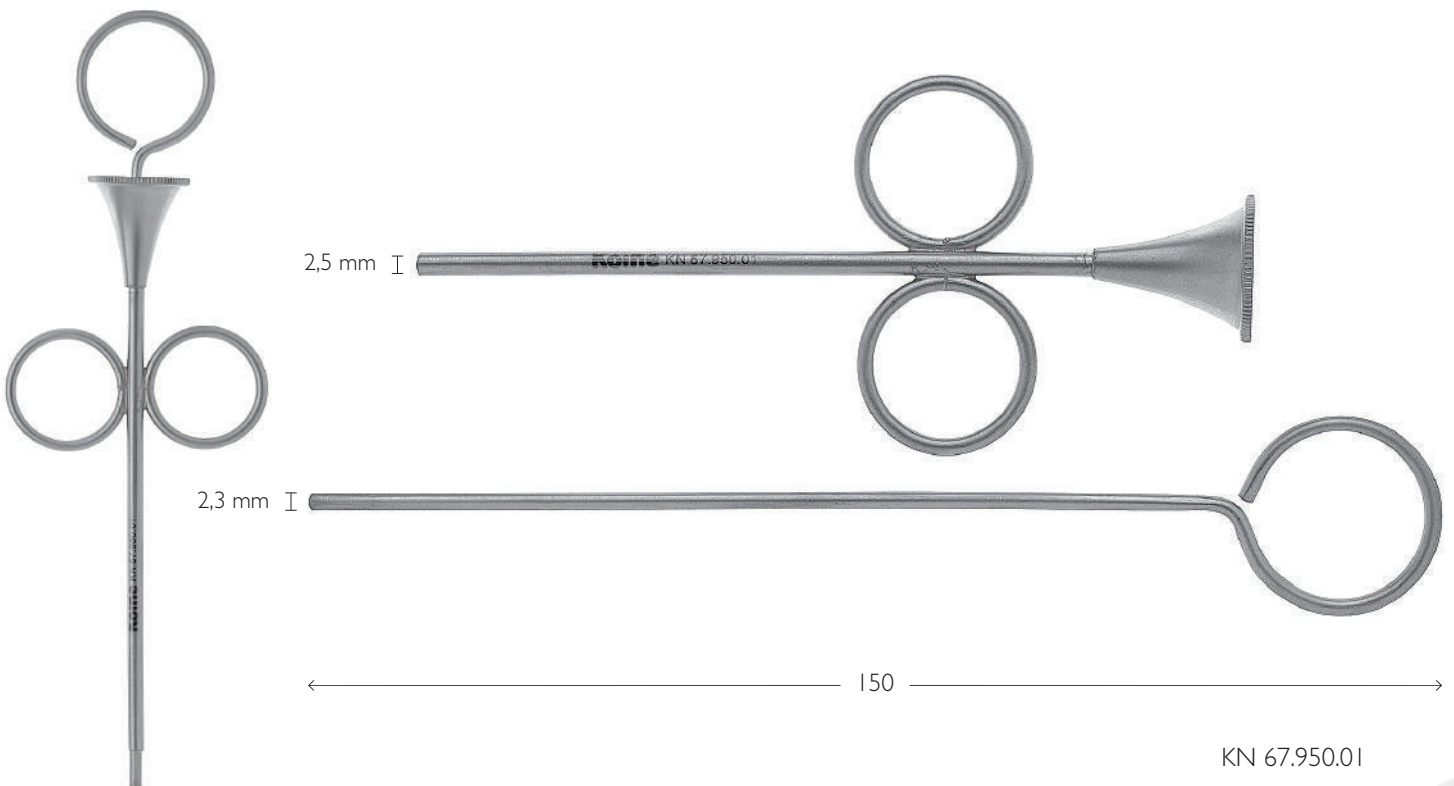
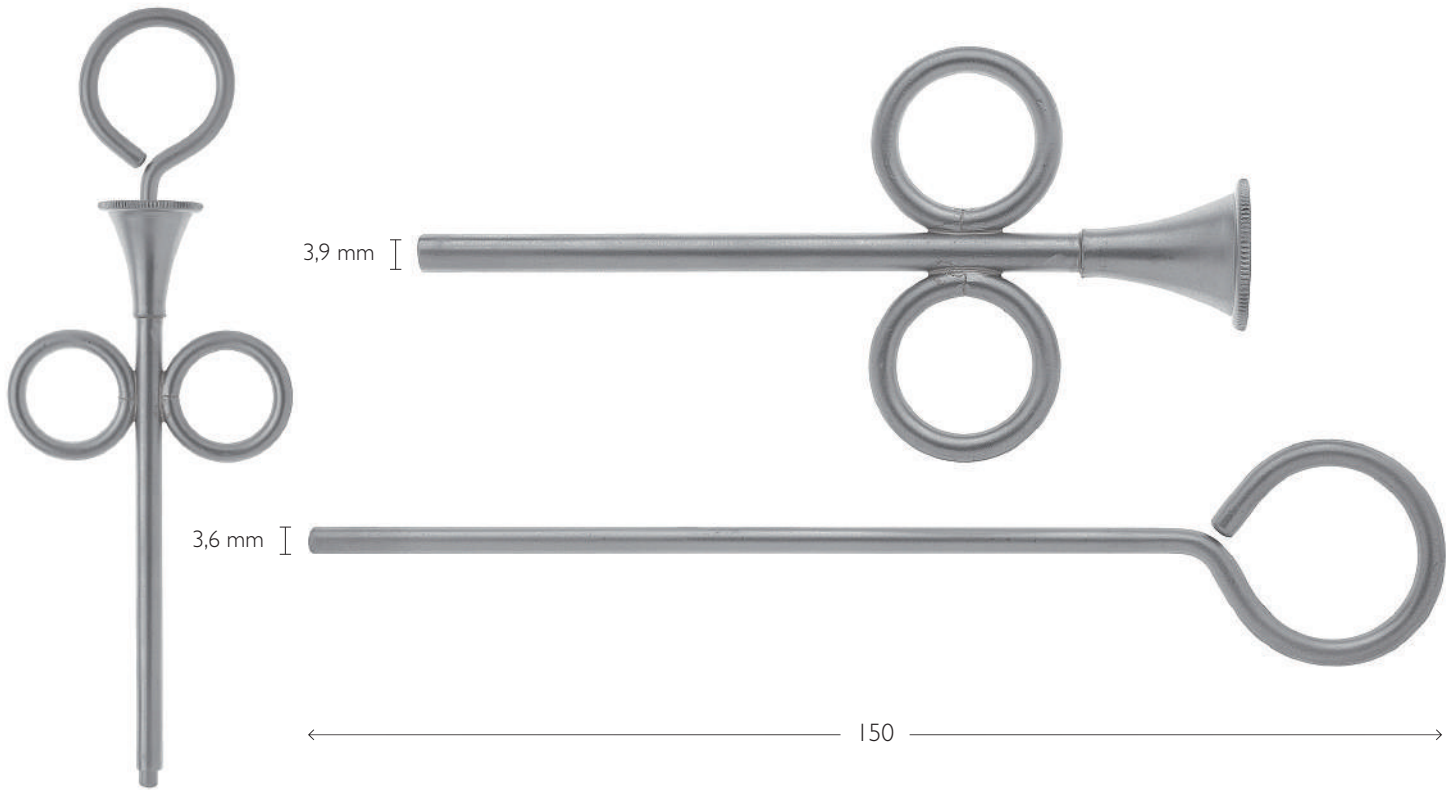



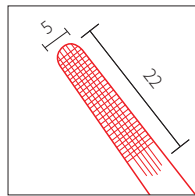

KN 80.004.00 Fig. 4

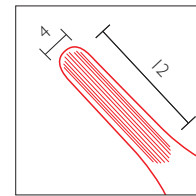

KN 80.013.00 Fig. 13

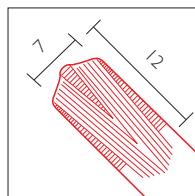

KN 80.022.00 Fig. 22

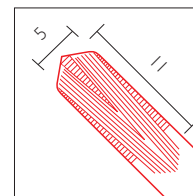

KN 80.037.00 Fig. 99/A

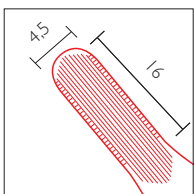
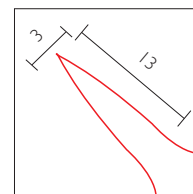

KN 80.033.00 Fig. 33

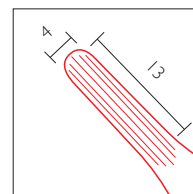

KN 80.033.01 Fig. 33/A





150

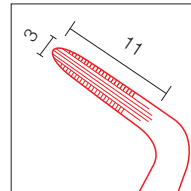
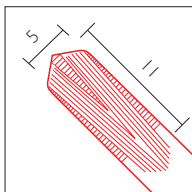
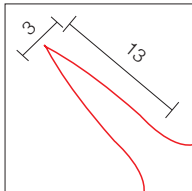

KN 80.038.00 Fig. 99

KN 80.045.00 Fig. 45

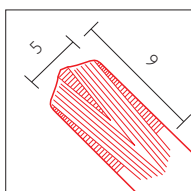
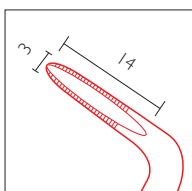

KN 80.046.00 Fig. 46

KN 80.073.00 Fig. 73

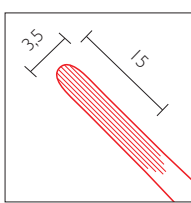
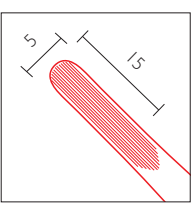

KN 80.074.00 Fig. 74

KN 80.074.14 Fig. 74N

Pinze estrazione

Strumentario

Koine

Extracting Forceps

Zahnzangen

Forceps de Extracción

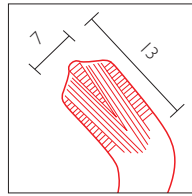

KN 80.079.00 Fig. 79

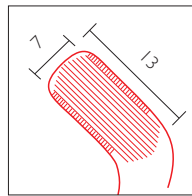

KN 80.079.01 Fig. 79/A

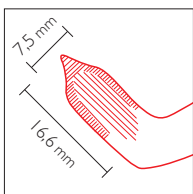

KN 80.079.03 Fig. 79/C

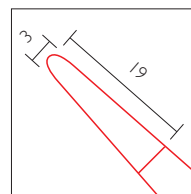

KN 80.086.00 Fig. 86

- Pinze estrazione
- Extracting Forceps
- Zahnzangen
- Forceps de Extracción



150

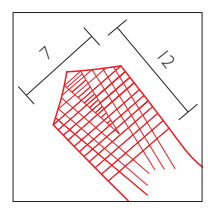

KN 80.222.51 Fig. 221/2R

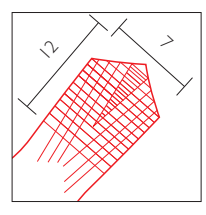

KN 80.222.52 Fig. 221/2L

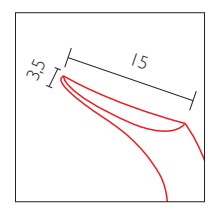

KN 80.300.00 Euler

- Pinze estrazione
- Extracting Forceps
- Zahnzangen
- Forceps de Extracción

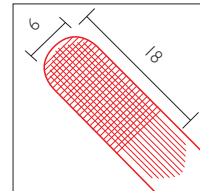

KN 80.001.00 Fig. 1

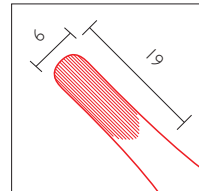

KN 80.002.00 Fig. 2

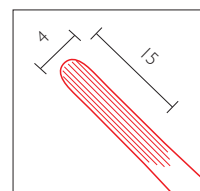

KN 80.029.00 Fig. 29

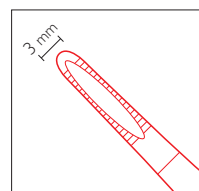

KN 80.041.00 Fig. 41

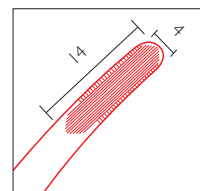

KN 80.044.00 Fig. 44

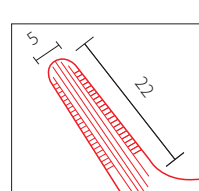

KN 80.051.00 Fig. 51

- Pinze estrazione
- Extracting Forceps
- Zahnzangen
- Forceps de Extracción

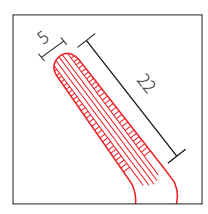

KN 80.051.01 Fig. 51/A

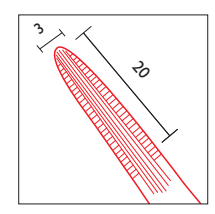

KN 80.051.05 Fig. 51/L

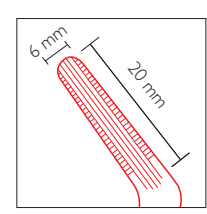

KN 80.052.00 Fig. 52

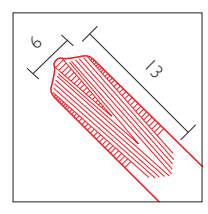

KN 80.067.01 Fig. 67/A

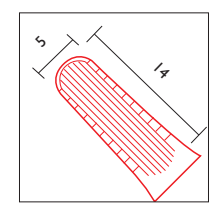

KN 80.067.00 Fig. 67

- Pinze estrazione
- Extracting Forceps
- Zahnzangen
- Forceps de Extracción



150

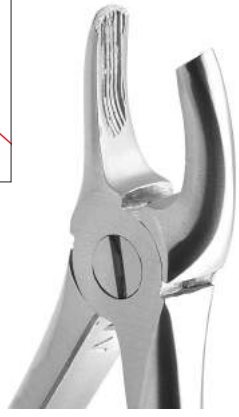
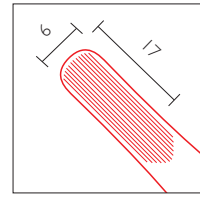

KN 80.007.00 Fig. 7

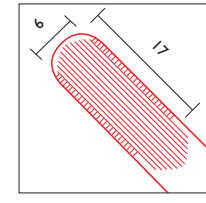

KN 80.017.00 Fig. 17

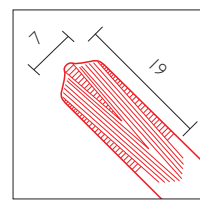

KN 80.018.00 Fig. 18

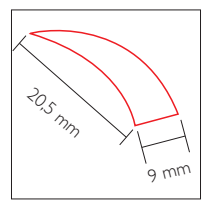

KN 80.087.00 Fig. 23

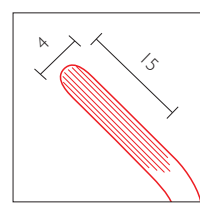
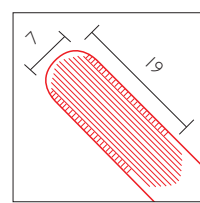

KN 80.030.00 Fig. 30

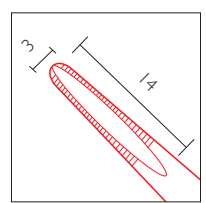

KN 80.049.00 Fig. 49

Pinze estrazione

Strumentario



Extracting Forceps

Zahnzangen

Forceps de Extracción

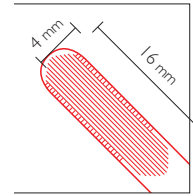
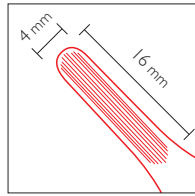

KN 80.860.00 Fig. 4

KN 80.861.00 Fig. 13

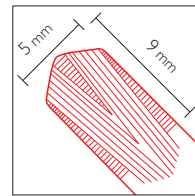
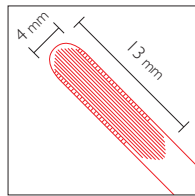

KN 80.863.00

KN 80.865.00

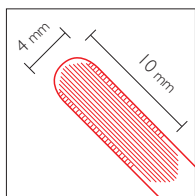

KN 80.867.00

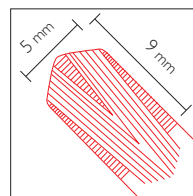

KN 80.869.00



Leve

Strumentario



Root Elevators

Wurzelheber

Botadores

Gärtner



← 120 →

KN 83.100.25
2,5 Ø



KN 83.102.25
2,5 Ø



KN 83.100.35
3,5 Ø



KN 83.102.35
3,5 Ø



KN 83.100.45
4,5 Ø



KN 83.102.45
4,5 Ø



KN 83.104.25
2,5 Ø



KN 83.105.25
2,5 Ø



KN 83.104.35
3,5 Ø



KN 83.105.35
3,5 Ø



KN 83.104.45
4,5 Ø



KN 83.105.45
4,5 Ø



KN 83.106.35
3,5 Ø



KN 83.107.35
3,5 Ø



KN 83.106.45
4,5 Ø



KN 83.107.45
4,5 Ø



KN 83.108.25
2,5 Ø



KN 83.109.35
3,5 Ø



KN 83.108.35
3,5 Ø



KN 83.109.45
4,5 Ø



Leve

Strumentario



Root Elevators

Wurzelheber

Botadores

Bein



140



KN 83.113.40
4 Ø



KN 83.103.30
3 Ø



KN 83.114.40
4 Ø



KN 83.103.40
4 Ø



140

KN 83.101.30
3 Ø



KN 83.101.40
4 Ø



KN 83.101.50
5 Ø



Flohr



140

KN 83.151.30
3 Ø



KN 83.152.30
3 Ø



Apikal



160

KN 83.161.30
3 Ø



KN 83.162.30
3 Ø





Leve

Strumentario



Root Elevators



Wurzelheber



Botadores

Heidbrink

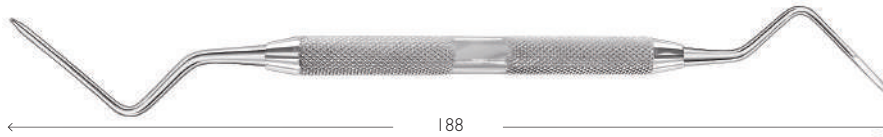

KN 83.140.15
1,5 Ø

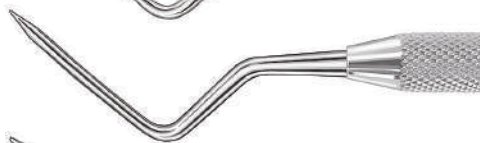

KN 83.140.18
1,8 Ø



KN 83.140.22
2,2 Ø

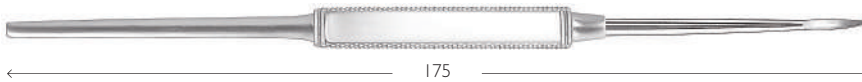

KN 83.142.18
1,8 Ø



KN 83.141.18
1,8 Ø

KN 83.143.18
1,8 Ø



154

KN 83.144.10
2 Ø



KN 83.145.10
2 Ø



KN 83.144.20
2 Ø



KN 83.145.20
2 Ø





Leve

Strumentario



Root Elevators



Wurzelheber



Botadores

Miller



KN 83.250.03
3 Ø



KN 83.250.04
4 Ø



KN 83.250.01
4 Ø



KN 83.250.02
4 Ø



Warwick - James



KN 83.146.02



KN 83.146.03



Luxator

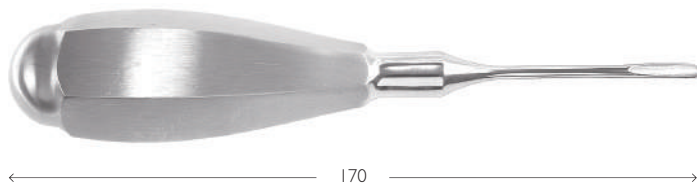

KN 83.390.30
3 Ø



KN 83.390.31
3 Ø



KN 83.390.50
5 Ø



KN 83.390.51
5 Ø



Periotomo



KN 02.790.00



KN 02.790.01



KN 02.790.02





Leve

Strumentario



Root Elevators



Wurzelheber



Botadores



← 155 →

KN 83.303.25
2,5 Ø



KN 83.304.25
2,5 Ø



KN 83.305.35
3,5 Ø



KN 83.306.35
3,5 Ø



KN 83.336.25
2,5 Ø



KN 83.336.35
3,5 Ø



← 155 →

KN 83.322.25
2,5 Ø



KN 83.323.25
2,5 Ø



KN 83.371.30
3 Ø



KN 83.373.40
4 Ø



KN 83.372.30
3 Ø



KN 83.374.40
4 Ø



← 160 →

KN 83.375.01



KN 83.375.02



Winter

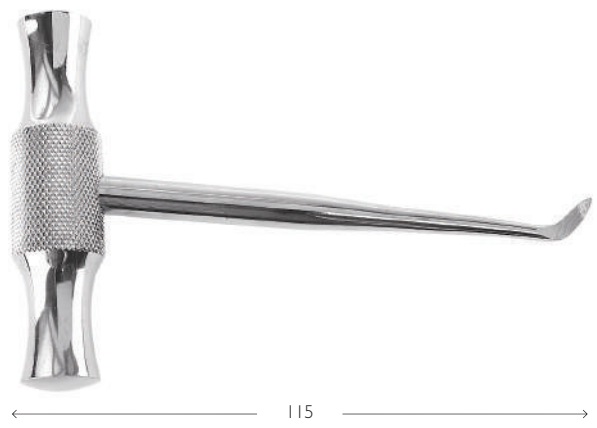

KN 83.762.01



KN 83.762.02



KN 83.763.01



KN 83.763.02



Barry



KN 83.761.01



KN 83.761.02



Creyer

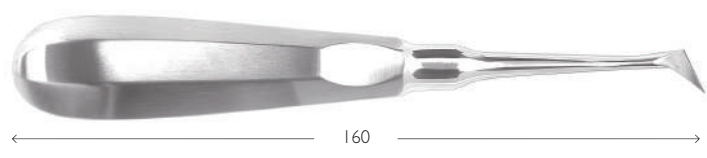

KN 83.760.01



KN 83.760.02





Leve

Strumentario



Root Elevators



Wurzelheber



Botadores

Bernard

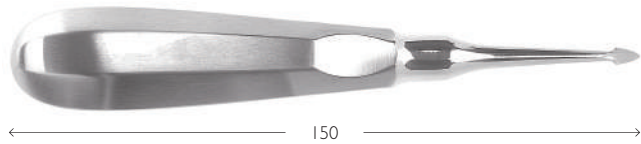

KN 83.391.01



KN 83.391.02

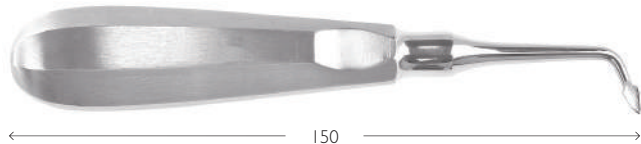

KN 83.391.06



KN 83.391.07



KN 83.400.00



KN 83.401.00



KN 83.401.04



KN 83.401.08



KN 83.401.01



KN 83.401.05



KN 83.401.09



KN 83.401.02



KN 83.401.06



KN 83.401.11



KN 83.401.03



KN 83.401.07





Spreaders

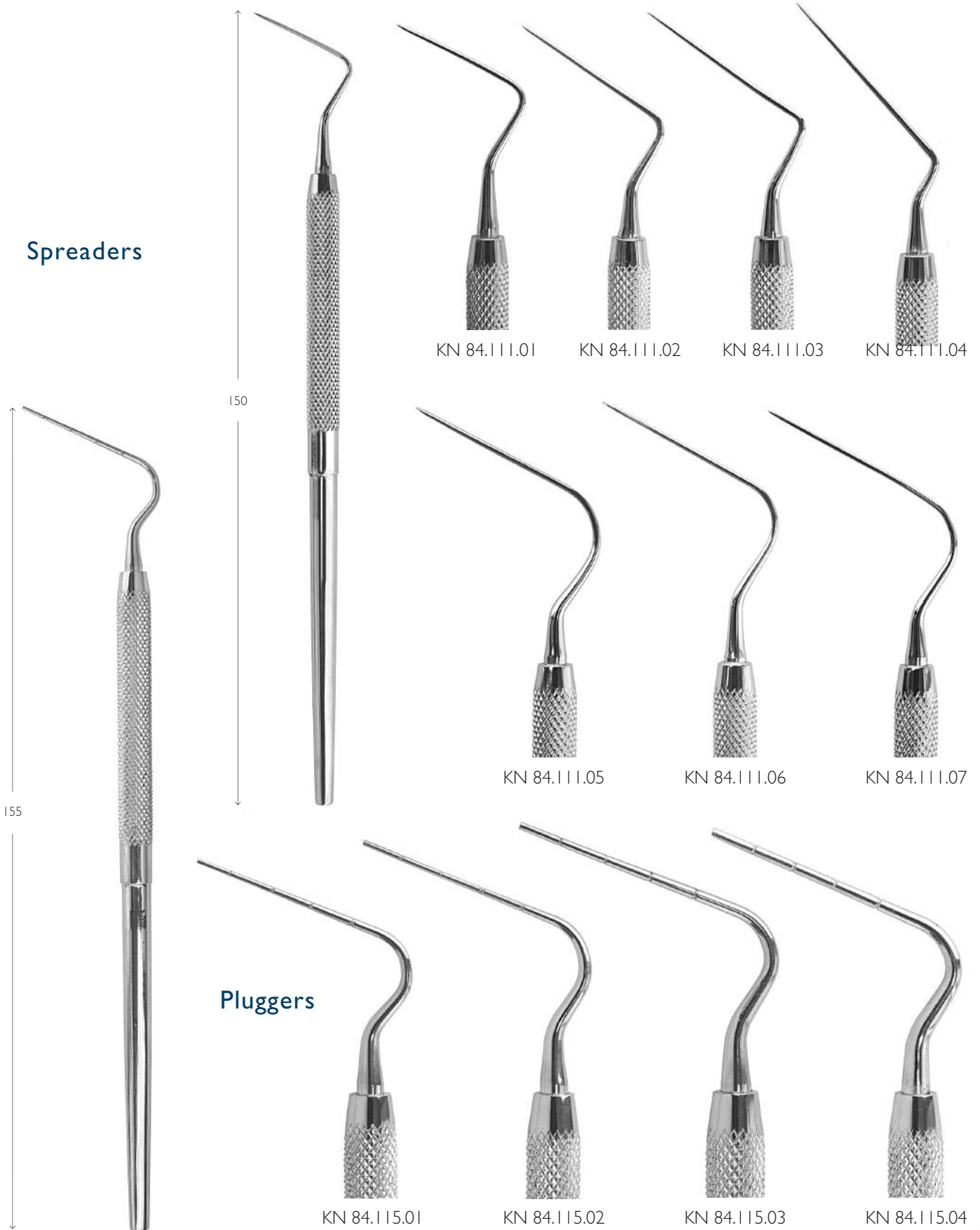

KN 84.111.01

KN 84.111.02

KN 84.111.03

KN 84.111.04

KN 84.111.05

KN 84.111.06

KN 84.111.07

Pluggers

KN 84.115.01

KN 84.115.02

KN 84.115.03

KN 84.115.04

- Sonde
- Probes
- Sonden
- Sondas

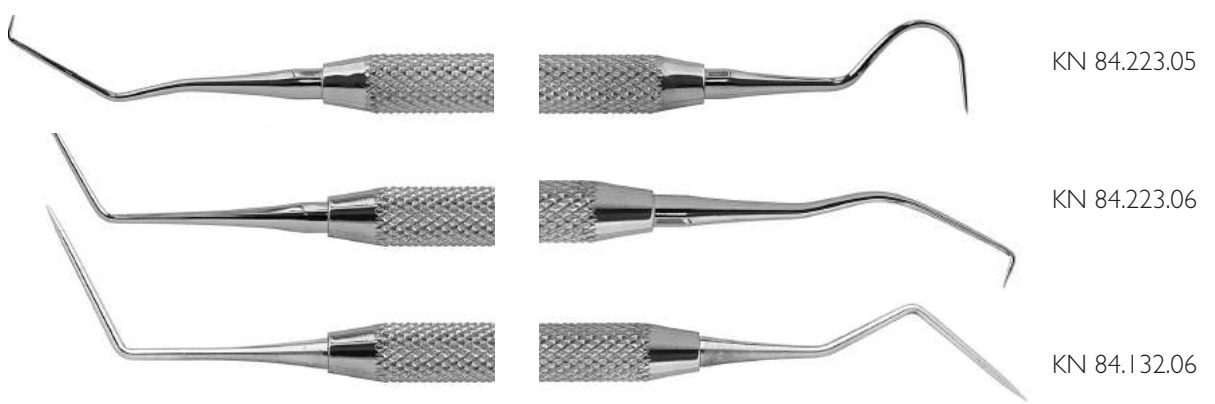
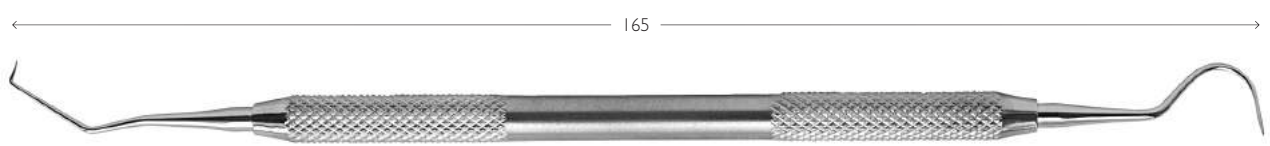
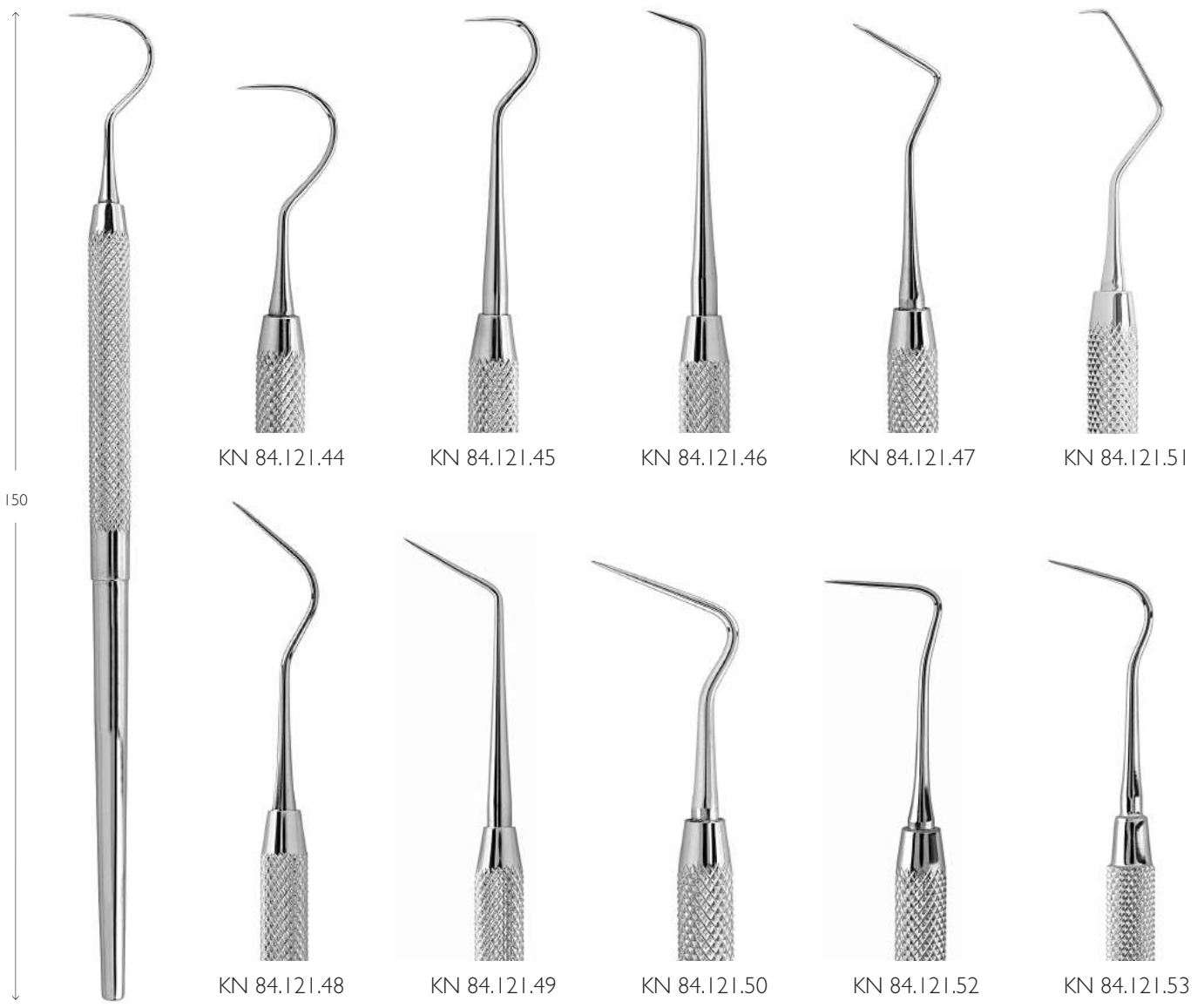

Manici per specchi

Strumentario



Handles for mirrors

Handgriffe für spiegel

Mango para espejos

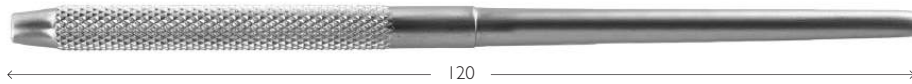

KN 84.150.01



KN 84.150.04

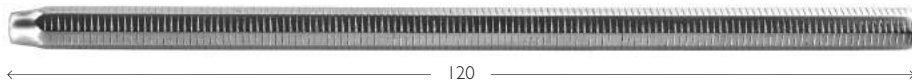

KN 84.150.02



KN 84.160.01

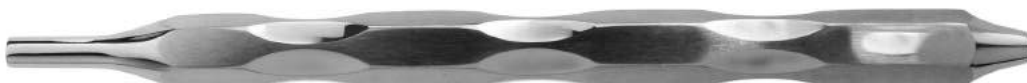

KN 84.150.05



KN 84.150.06

- Siringhe
- Syringes
- Spritzen
- Jeringas



KN 84.103.01
cavatappi



KN 84.103.02

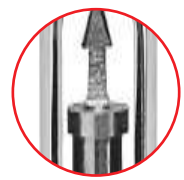

KN 84.101.01



KN 84.101.02

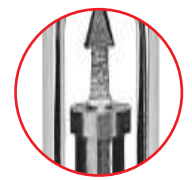

KN 84.102.01



KN 84.102.02

- Siringhe
- Syringes
- Spritzen
- Jeringas

KN 84.104.00



KN 84.105.00

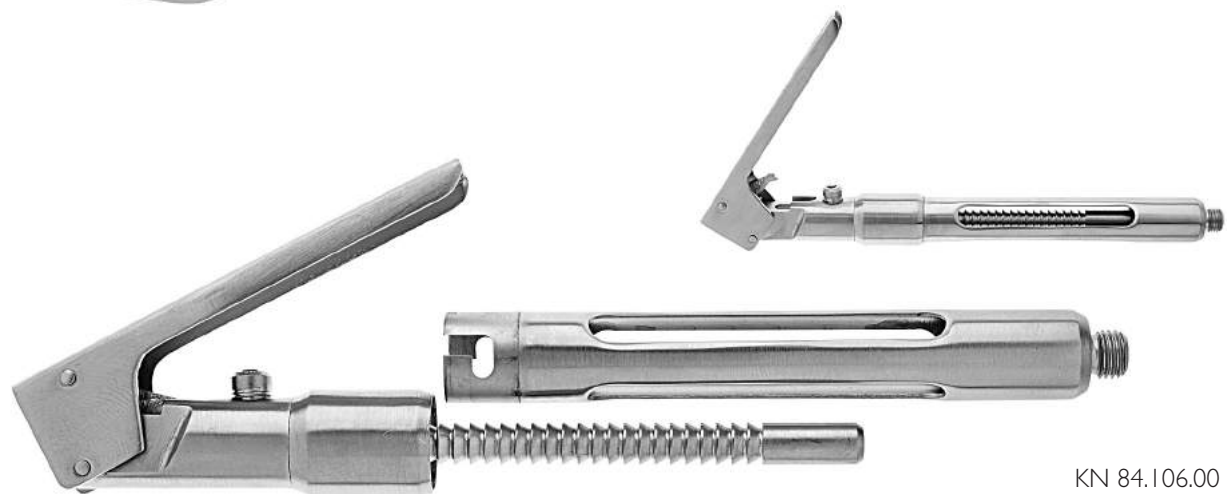

KN 84.106.00

Spatole per cemento

Strumentario



Cement spatulas

Zementspatel

Espatulas para cemento

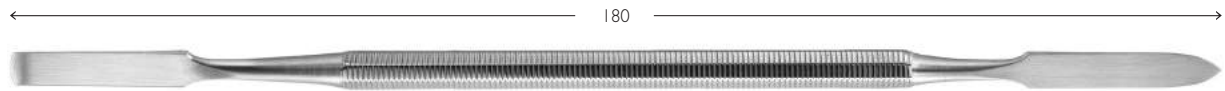

Heidemann





Otturatori

Strumentario



Filling instruments



Fullungsinstrumente



Instrumentos para obturaciones

Pallina

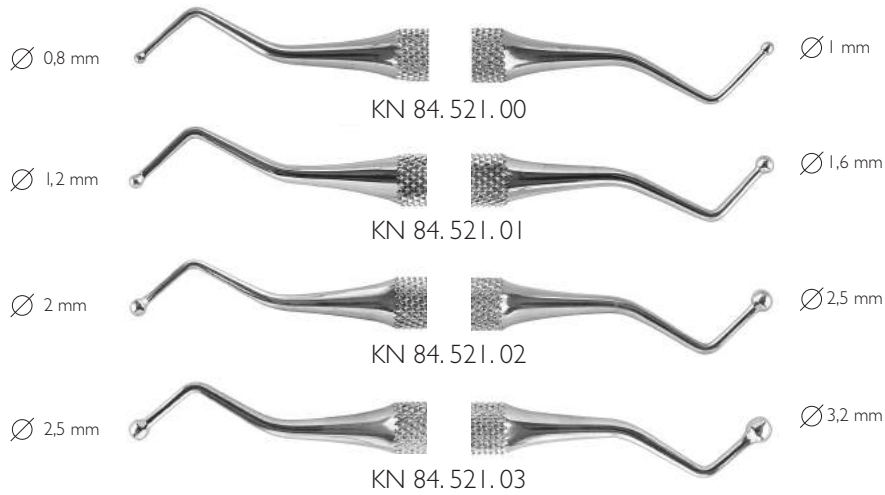

Pera

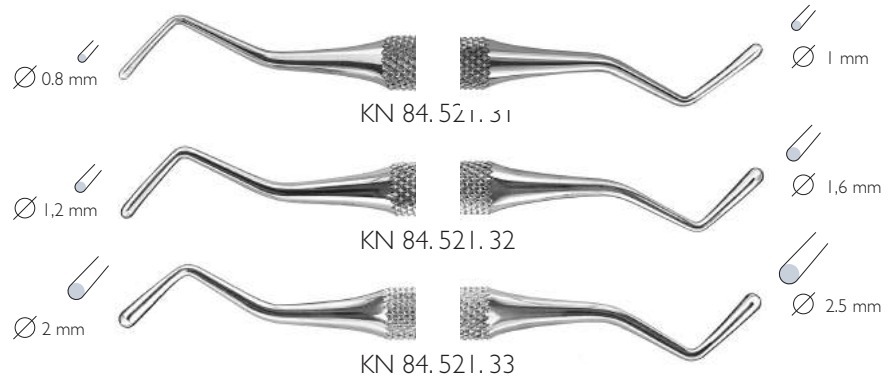

Pallina / Spatola

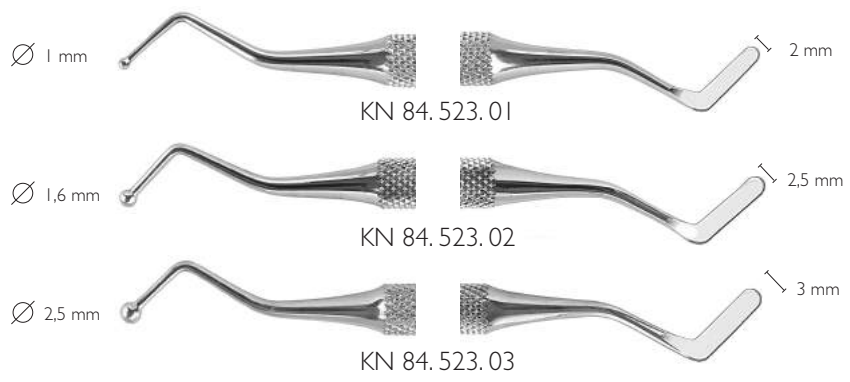

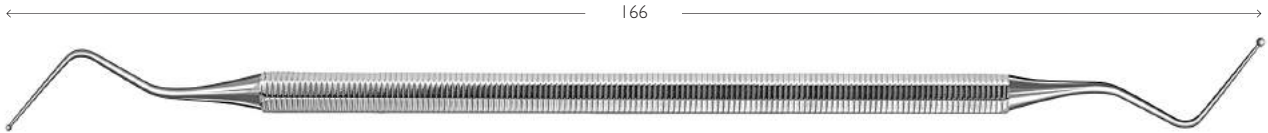

Hollenback

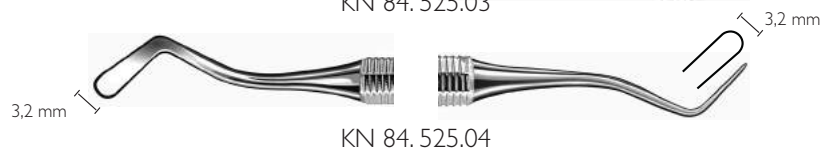
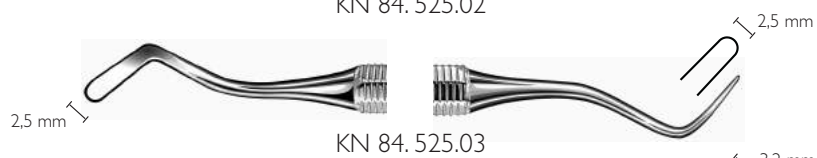
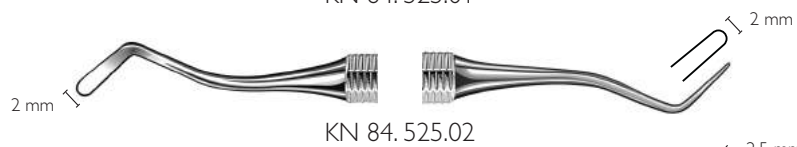

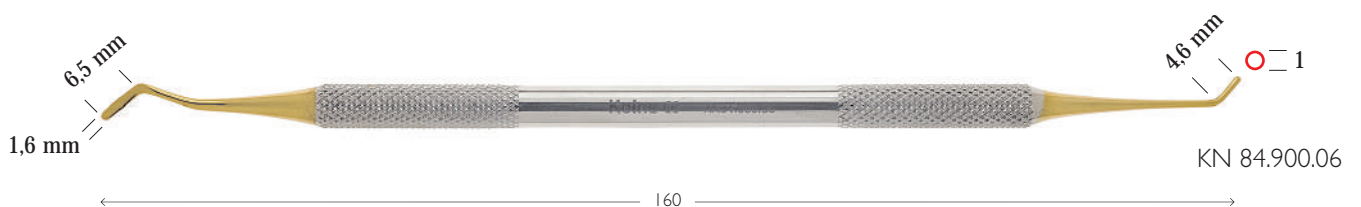
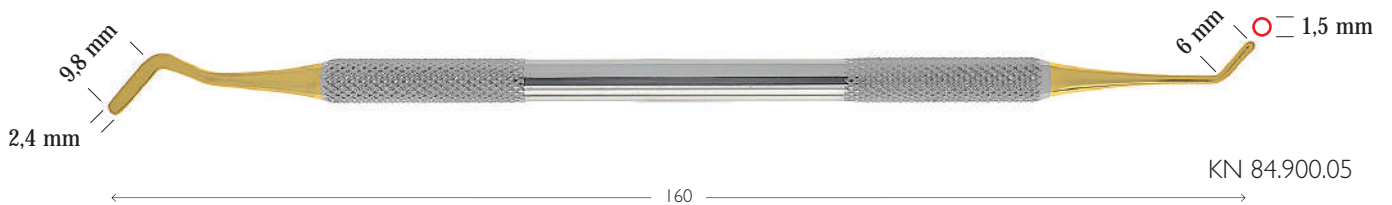
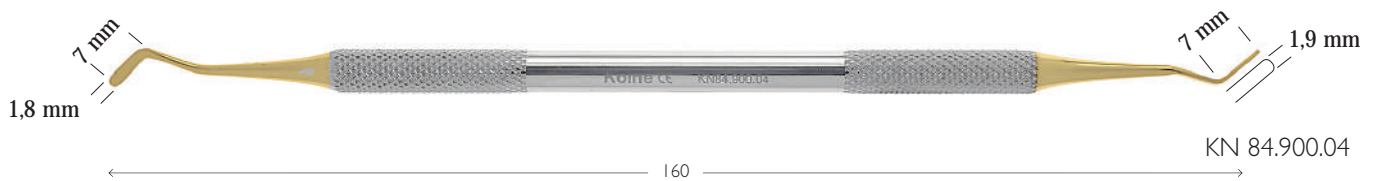
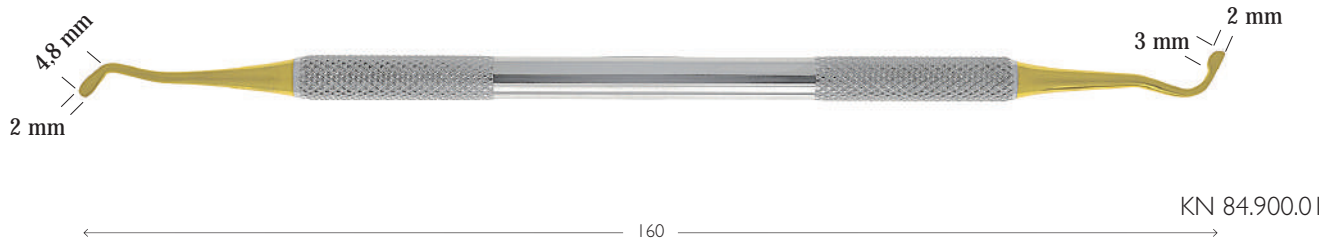



Pinza Foradiga & Pinze per Ganci

Strumentario



Kofferdam-Lochzange Kofferdam-Klammerzangen



Rubberdam punch Rubberdam clamp forceps



Perforador para dique de caucho Pinzas de engrapar para dique de caucho



KN 84.425.00
ARCO DI YOUNG



PINZA PER GANCI IVORY KN 84.438.00

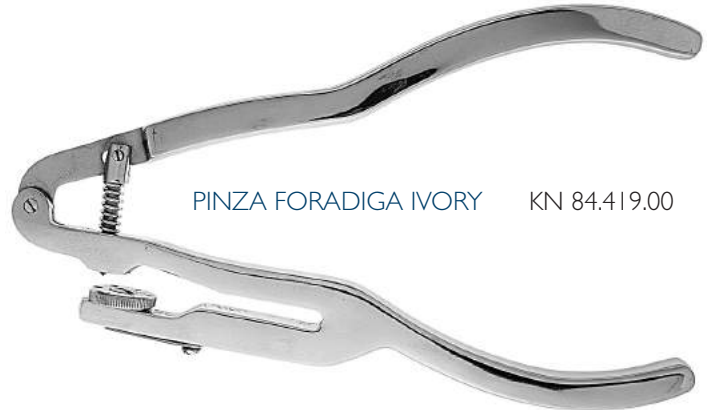

PINZA FORADIGA IVORY KN 84.419.00

← 140 →



PINZA FORADIGA ANISWORTH KN 84.420.00

← 170 →

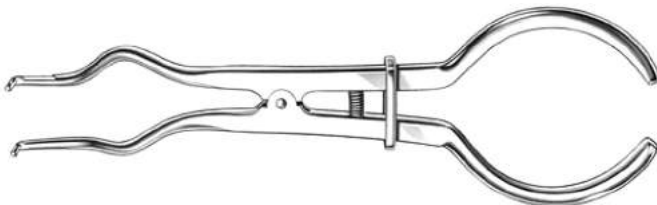

PINZA PER GANCI BREWER KN 84.429.00

← 170 →

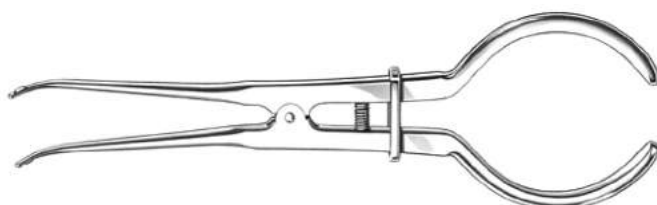

PINZA PER GANCI STOKE KN 84.431.00



Sonde Parodontali

Strumentario



Parodontometer

Periodontometers

Sondas Para Periodoncia

Manico Speciale

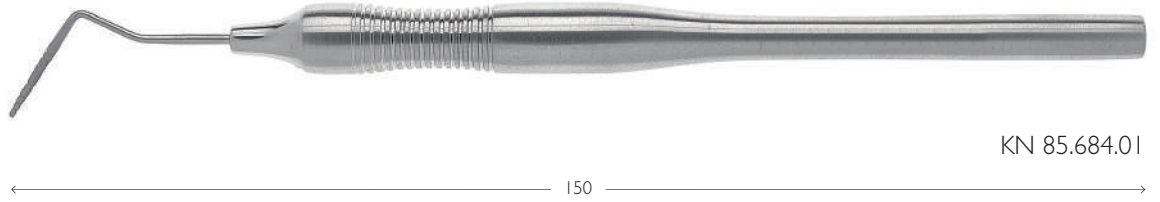
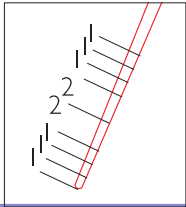

KN 85.684.01

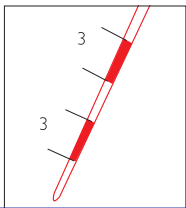

KN 85.684.03

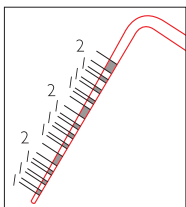

KN 85.684.05

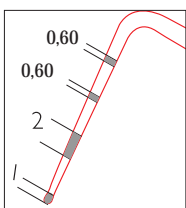

KN 85.684.06

Sonde parodontali

Strumentario



Periodontal probes

Periodontometers

Sondas periodontale

Manico Standard

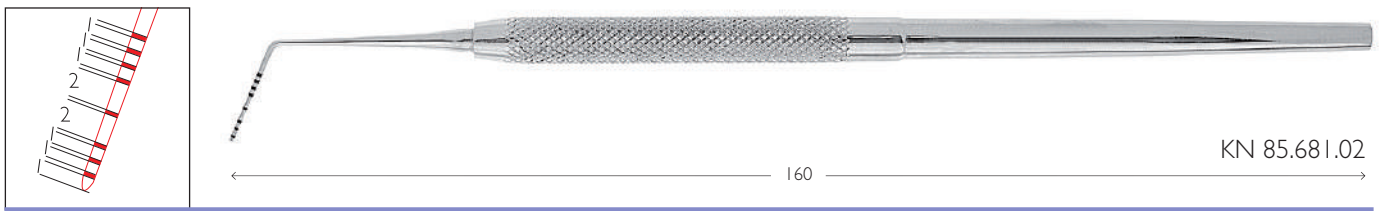
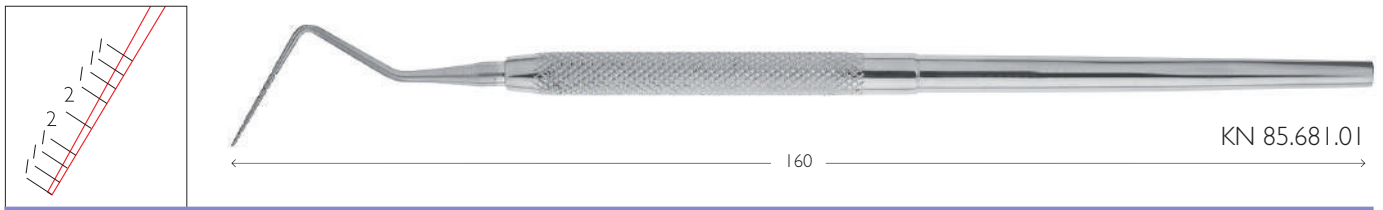

Sonde parodontali doppie

Strumentario



Periodontal probes double

Periodontometers doppel

Sondas periodontale dobles

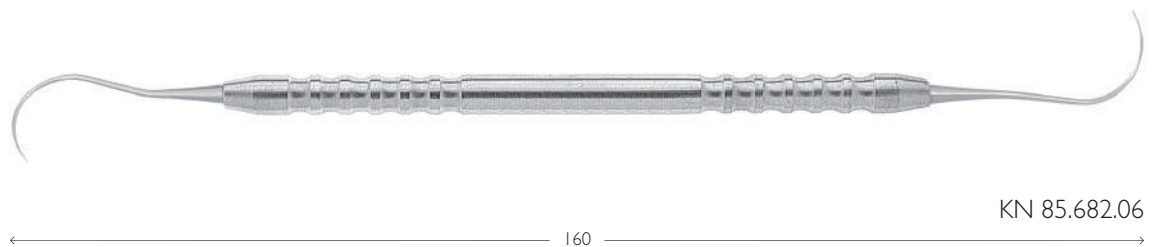
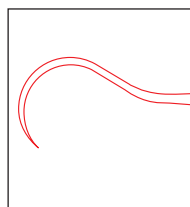
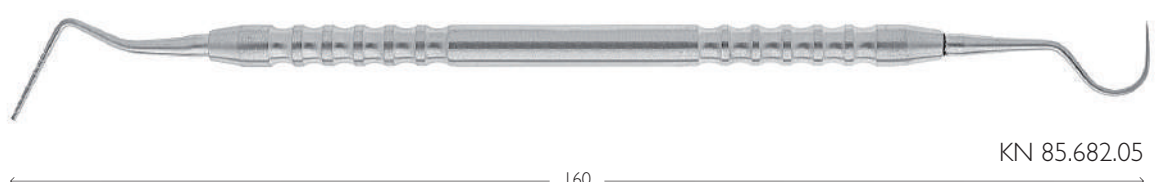
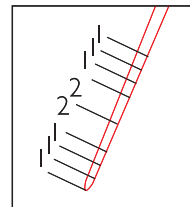
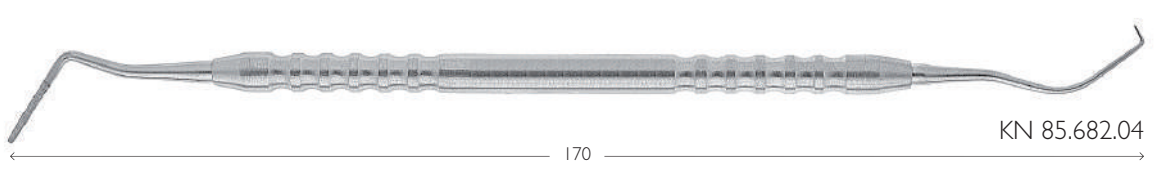
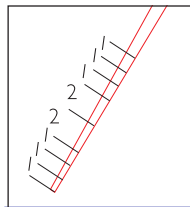
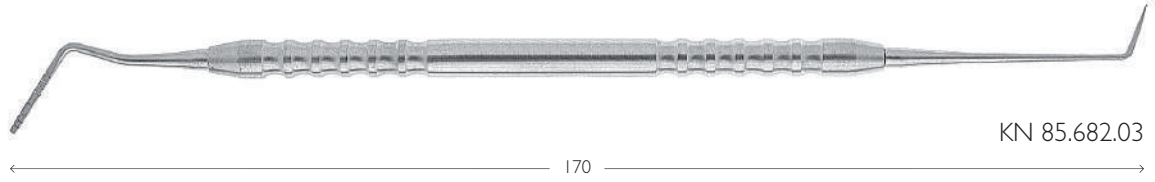
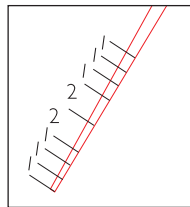
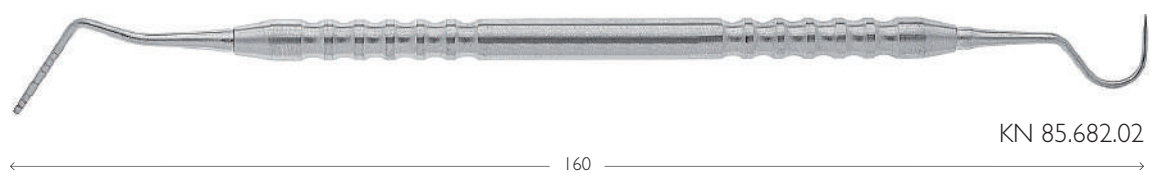
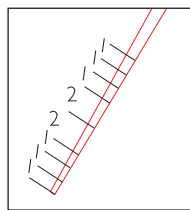
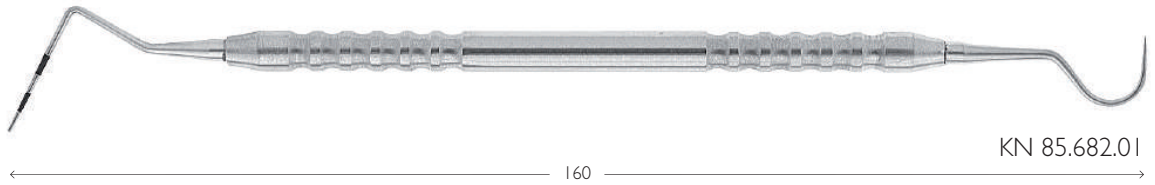
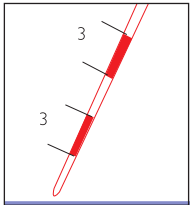

Curette - Scaler

Strumentario



Curettes - Scaler

Küretten - Scaler

Curetas - Scaler



1/2 KN 85.820.01



3/4 KN 85.820.02



5/6 KN 85.820.03



7/8 KN 85.820.04

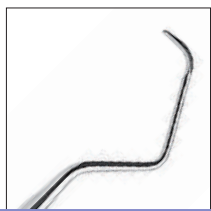

9/10 KN 85.820.05



11/12 KN 85.820.06



13/14 KN 85.820.07



- Curette - Scaler
- Curettes - Scaler
- Küretten - Scaler
- Curetas - Scaler

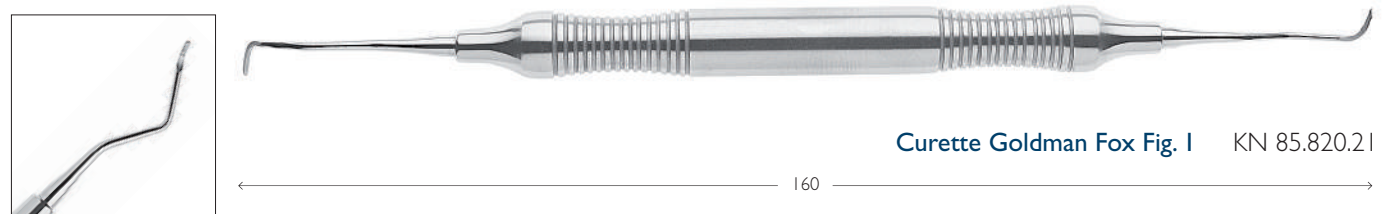

Curette Goldman Fox Fig. 1 KN 85.820.21



Curette Goldman Fox Fig. 2 KN 85.820.22

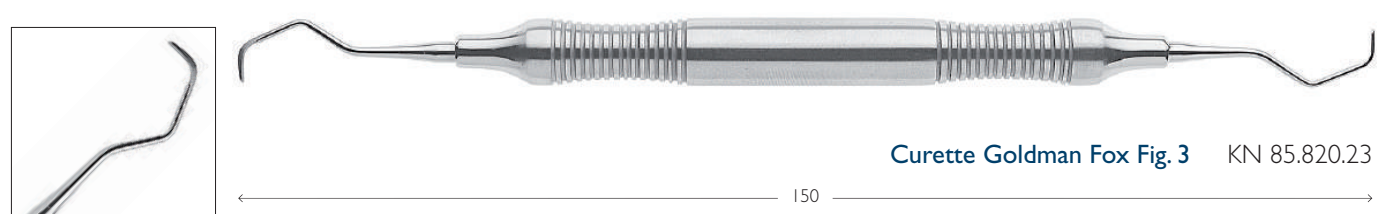

Curette Goldman Fox Fig. 3 KN 85.820.23

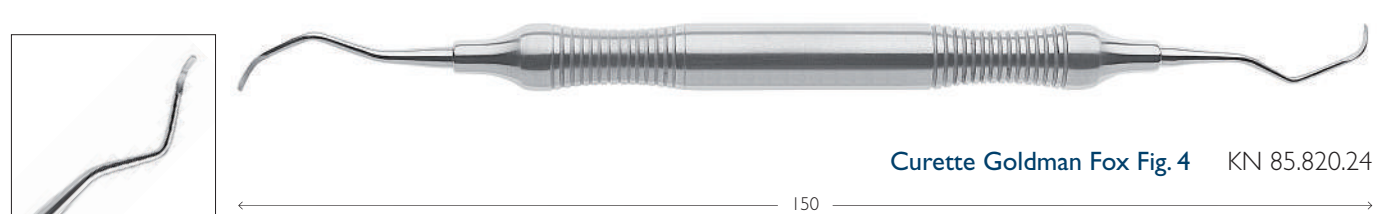

Curette Goldman Fox Fig. 4 KN 85.820.24



Scaler 204S KN 85.819.00



Scaler CI/2-3 KN 85.819.01

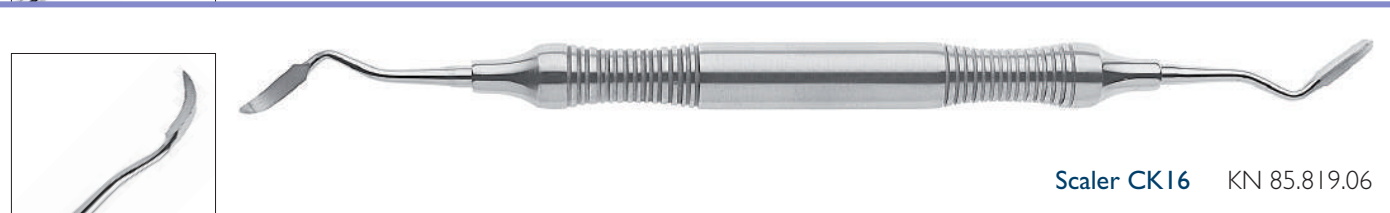

Scaler CK16 KN 85.819.06

Curette Gracey

Strumentario

Koine

Gracey curettes

Gracey-Küretten

Curetas Gracey

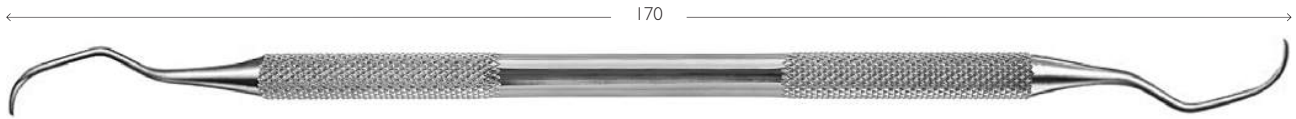

KN 85.781.01 GR 1/2



KN 85.781.02 GR 3/4



KN 85.781.03 GR 5/6



KN 85.781.04 GR 7/8



KN 85.781.05 GR 9/10



KN 85.781.06 GR 11/12



KN 85.781.07 GR 13/14

- Bisturi
- Scalpel
- Skalpelli
- Bisturi

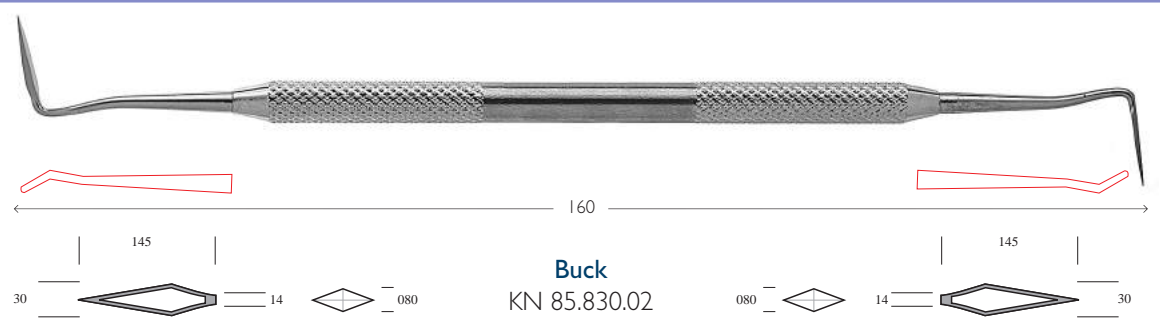

- Bisturi
- Scalpel
- Skalpelli
- Bisturi

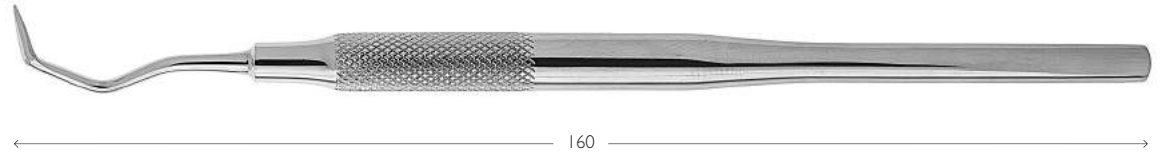

Orban 1 KN 85.825.01

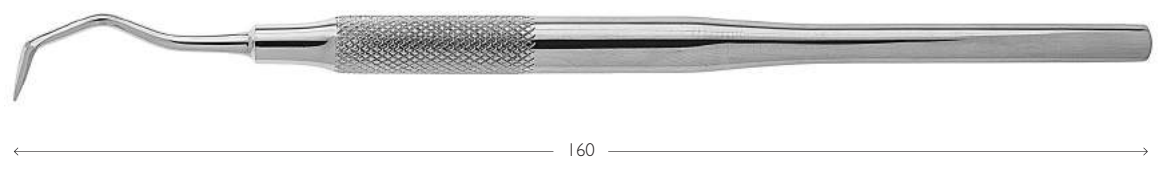

Orban 2 KN 85.825.02

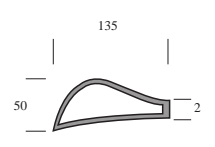
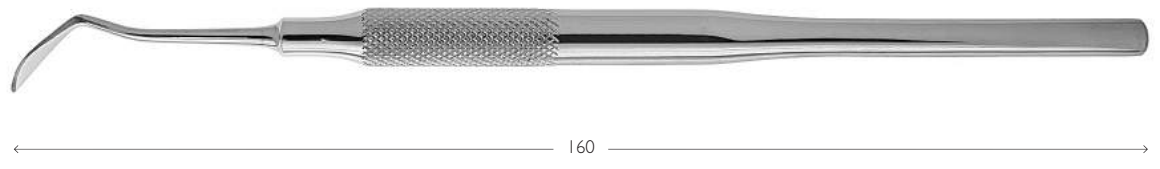

Kirkland 15 KN 85.823.15

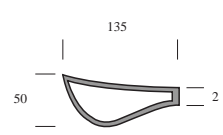
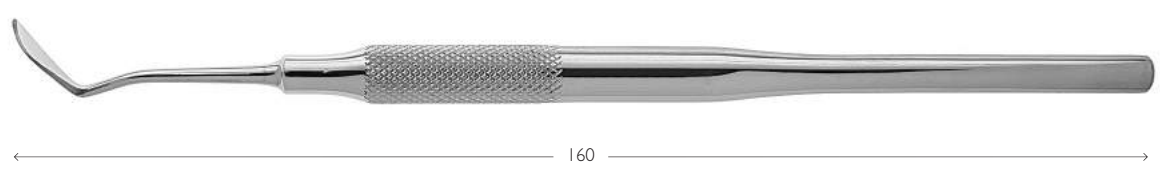

Kirkland 16 KN 85.823.16

- Bisturi
- Scalpel
- Skalpelli
- Bisturi

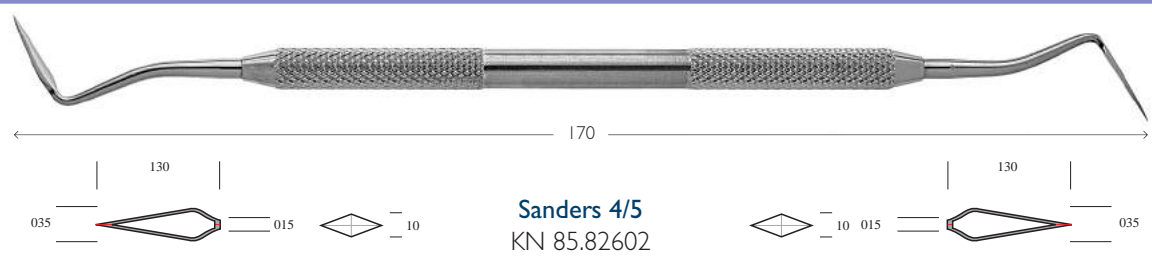

- Bisturi
- Scalpel
- Skalpelli
- Bisturi

MANICO SPECIALE



Orban 1 KN 85.821.01



Orban 2 KN 85.821.02

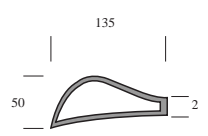

Kirkland 15 KN 85.821.15

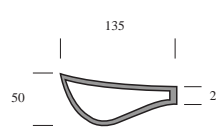

Kirkland 16 KN 85.821.16

- Bisturi
- Scalpel
- Skalpelli
- Bisturi

MANICO SPECIALE

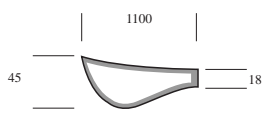

Kirkland K15/16
KN 85.821.17

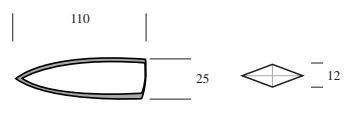
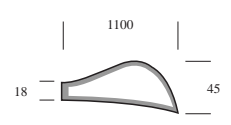

Orban I/2
KN 85.821.03

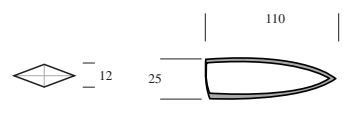



Pinze per Prowisori

Strumentario

Koine

Crown removin pliers

Kronenabnahmezangen

Forceps saca-coronas



KN 87.500.01

170



KN 87.500.02

160



KN 87.500.03

170

Martelletto sfilacorone

Strumentario



Kronenentferner

Crown Removers

Arrancacoronas



KN 87.580.01

Leva sfilacorone



KN 87.580.00

Pinza Gutowsky



KN 87.583.00

Martelletto Sfila Corone



140

KN 87.581.00



40,5

KN 87.581.01



40,5

KN 87.581.02



60

KN 87.581.03



Porta impronta

Strumentario



Abdrucklöffel

Impression Tray

Cubetas para impresione



KN 88.130.24



KN 88.130.23



KN 88.130.22



KN 88.130.21

	L mm	h mm
KN 88.130.24	79	70
KN 88.130.23	76	67
KN 88.130.22	70	64
KN 88.130.21	73	60

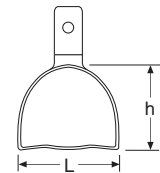

KN 88.130.11



KN 88.130.12



KN 88.130.13



KN 88.130.14

	L mm	h mm
KN 88.130.11	86	64
KN 88.130.12	70	64
KN 88.130.13	73	60
KN 88.130.14	70	57

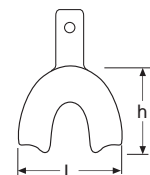

Porta impronta

Strumentario



Abdrucklöffel

Impression Tray

Cubetas para impresione



KN 88.100.16



KN 88.100.15



KN 88.100.14



KN 88.100.13



KN 88.100.12



KN 88.100.11

	L mm	h mm
KN 88.100.16	78	61
KN 88.100.15	76	59
KN 88.100.14	74	57
KN 88.100.13	72	54
KN 88.100.12	60	49
KN 88.100.11	55	47

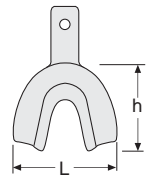

KN 88.100.26



KN 88.100.25



KN 88.100.24



KN 88.100.23



KN 88.100.22



KN 88.100.21

	L mm	h mm
KN 88.100.26	73	62
KN 88.100.25	71	60
KN 88.100.24	69	57
KN 88.100.23	66	53
KN 88.100.22	64	51
KN 88.100.21	61	47

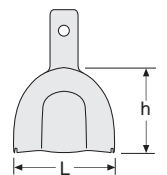

Porta impronta

Strumentario



Abdrucklöffel

Impression Tray

Cubetas para impresione



KN 88.110.16



KN 88.110.15



KN 88.110.14



KN 88.110.13



KN 88.110.12



KN 88.110.11

	L mm	h mm
KN 88.110.16	78	61
KN 88.110.15	76	59
KN 88.110.14	74	57
KN 88.110.13	72	52
KN 88.110.12	60	49
KN 88.110.11	55	47

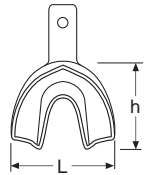

KN 88.110.26



KN 88.110.25



KN 88.110.24



KN 88.110.23



KN 88.110.22



KN 88.110.21

	L mm	h mm
KN 88.110.26	73	62
KN 88.110.25	71	60
KN 88.110.24	69	57
KN 88.110.23	66	53
KN 88.110.22	64	51
KN 88.110.21	61	47

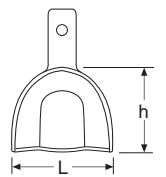

KN 88.115.02



KN 88.115.00



KN 88.115.01

Porta impronta

Strumentario



Abdrucklöffel

Impression Tray

Cubetas para impresione



KN 88.120.21



KN 88.120.22



KN 88.120.23



KN 88.120.24



KN 88.120.25



KN 88.120.26

	L mm	h mm
KN 88.120.21	73	62
KN 88.120.22	71	60
KN 88.120.23	69	57
KN 88.120.24	66	53
KN 88.120.25	64	51
KN 88.120.26	61	47

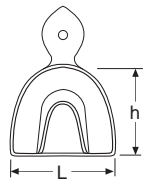

KN 88.120.11



KN 88.120.12



KN 88.120.13



KN 88.120.14



KN 88.120.15



KN 88.120.16

	L mm	h mm
KN 88.120.11	78	61
KN 88.120.12	76	59
KN 88.120.13	74	57
KN 88.120.14	72	54
KN 88.120.15	60	49
KN 88.120.16	55	47

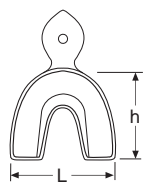

KN 88.125.01



KN 88.125.00



KN 88.125.02



- Laboratorio
- Laboratory
- Labor
- Laboratorio



- Laboratorio
- Laboratory
- Labor
- Laboratorio



- Laboratorio
- Laboratory
- Labor
- Laboratorio



- Laboratorio
- Laboratory
- Labor
- Laboratorio

← 170 mm →



KN 89.740.01

← 165 mm →



KN 89.740.02

- Laboratorio
- Laboratory
- Labor
- Laboratorio

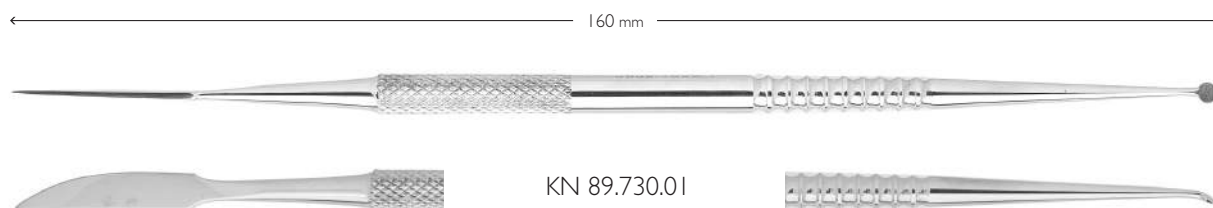

- Laboratorio
- Laboratory
- Labor
- Laboratorio

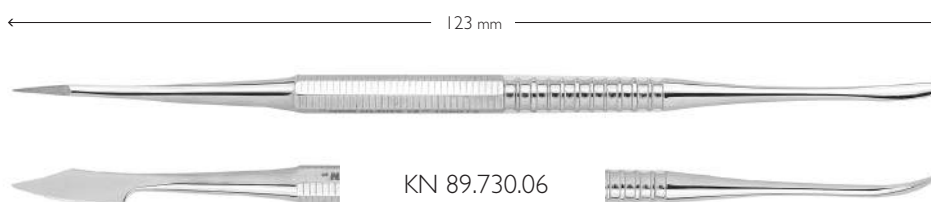
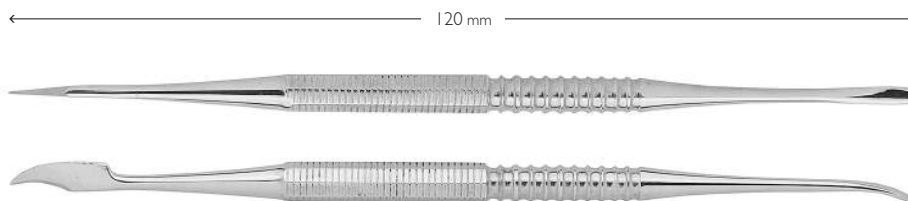

- Laboratorio
- Laboratory
- Labor
- Laboratorio

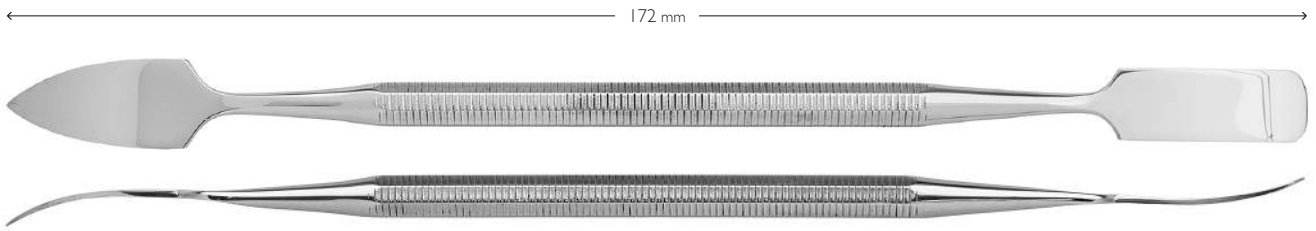

KN 89.730.10

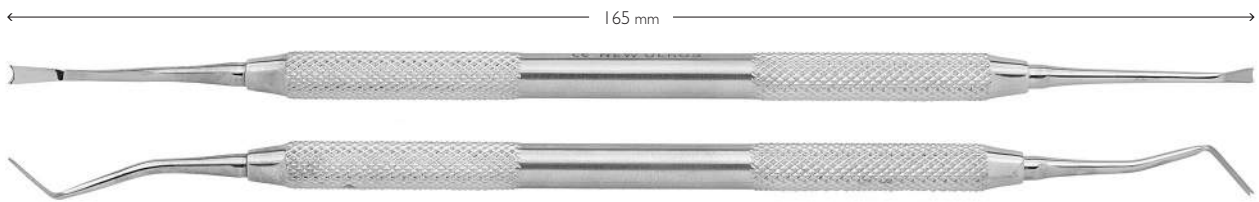

KN 89.730.11



KN 89.730.12

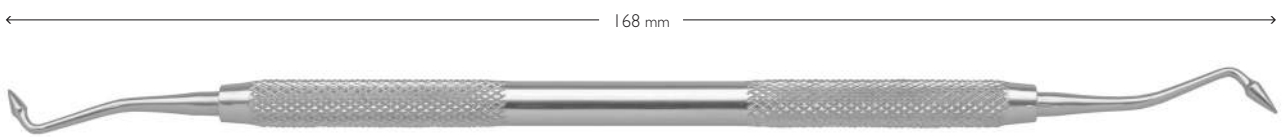

KN 89.730.13

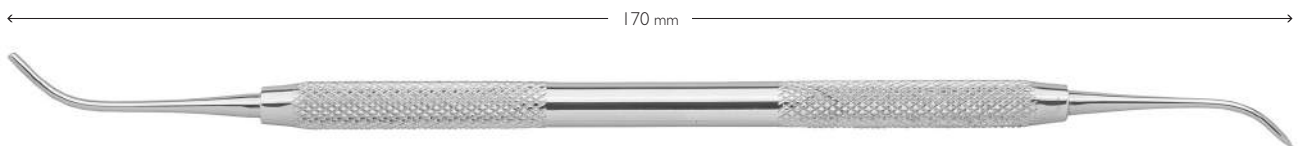

KN 89.730.14

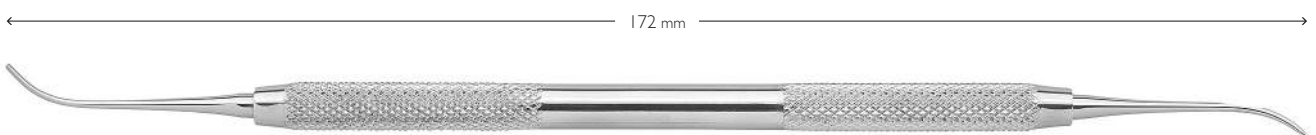

KN 89.730.15

- Laboratorio
- Laboratory
- Labor
- Laboratorio

← 205 mm →



KN 89.740.00

← 187 mm →



KN 89.720.12



Oliver Jones

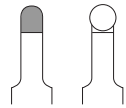

KN 89.265.15

← 130 →

Oliver Jones

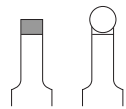

KN 89.265.10

← 120 →

Tweed archi TC



KN 89.500.01

Tronchese distale

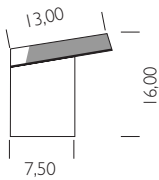

KN 89.500.15

Tronchese

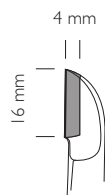

KN 89.500.16

Tronchese



KN 89.500.17

Mathieu punta fine

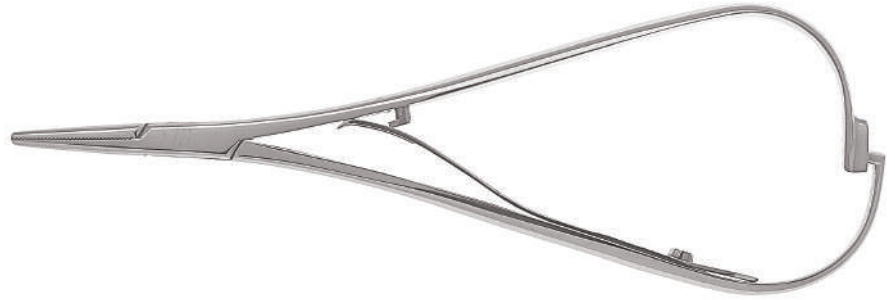
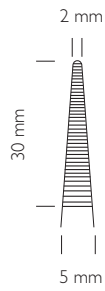

KN 89.250.14

← 140 →

Pinza per separazione

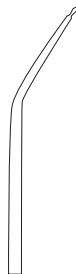

KN 89.255.16

← 150 →

Pinza universale inox

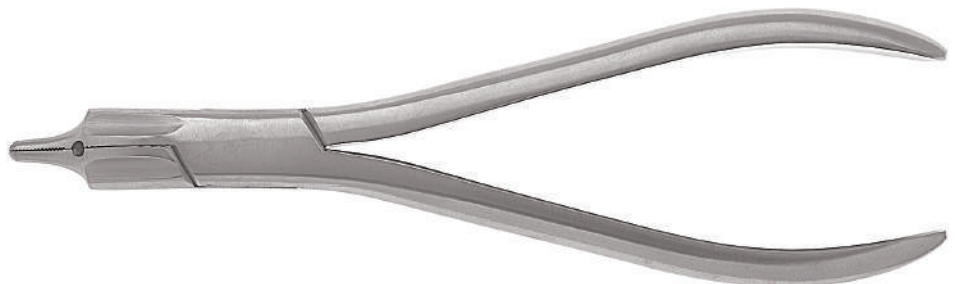

KN 89.260.16

← 160 →

Tronchese distale piccolo



KN 89.580.01

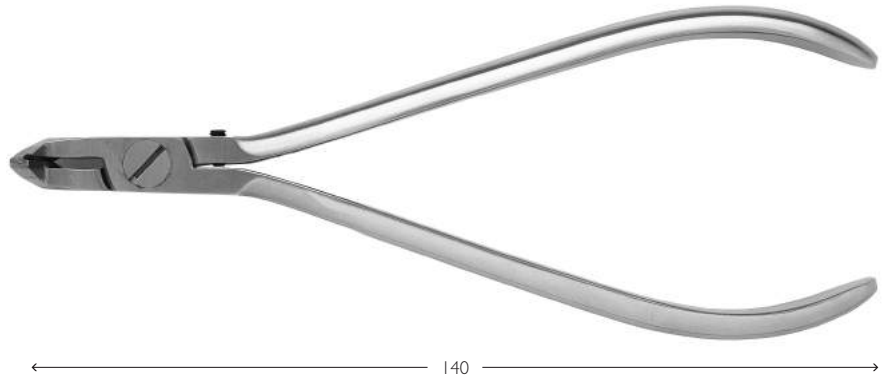

Tronchese

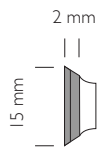

KN 89.500.18



Tronchese

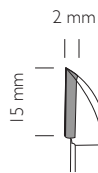

KN 89.500.53

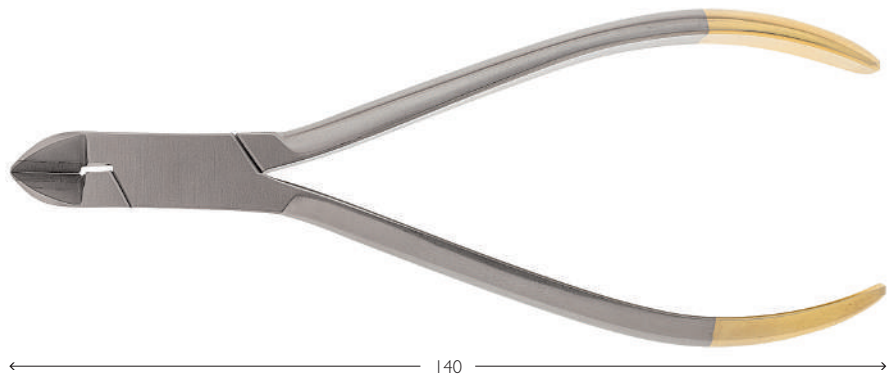

Tronchese per legature

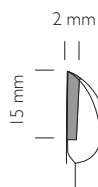

KN 89.600.00

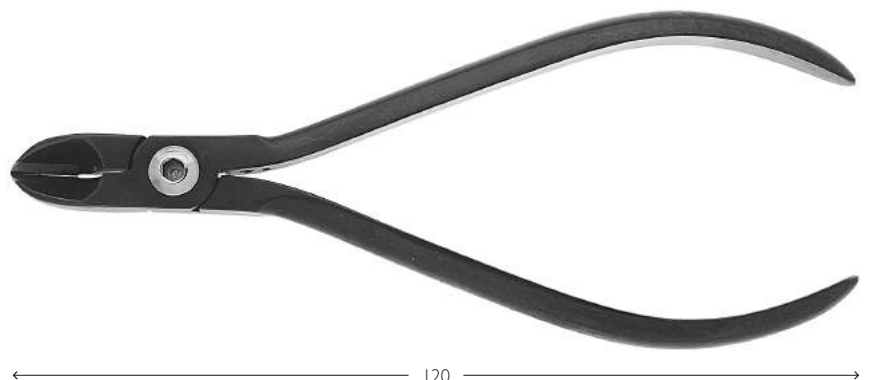

Strumenti per ortodonzia

Strumentario



Instruments for orthodontia

Instrumente für die orthodontie

Instrumentos de ortodoncia

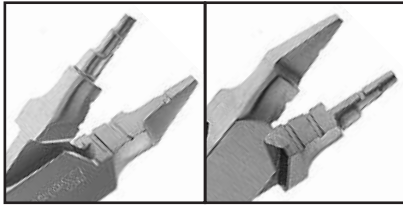

● da 0,15 a 0,35

■ da 0,15 a 0,35



← 130 →

Young KN 89.300.13

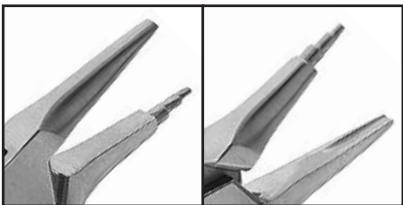

● da 0,15 a 0,35

■ da 0,15 a 0,35



← 130 →

Tweed sottile KN 89.351.13

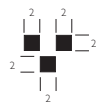
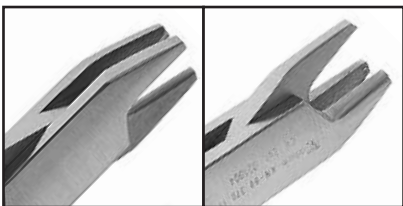

← 130 →

Aderer KN 89.370.11

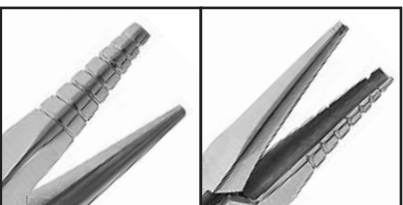

● da 2,00 a 7,40

☪ da 3,70 a 7,00



← 135 →

Schwarz KN 89.380.14

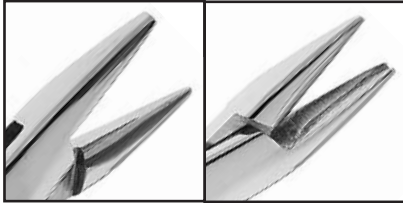

● da 1,20 a 7,40

☪ da 3,00 a 7,00

Wire bending KN 89.430.13

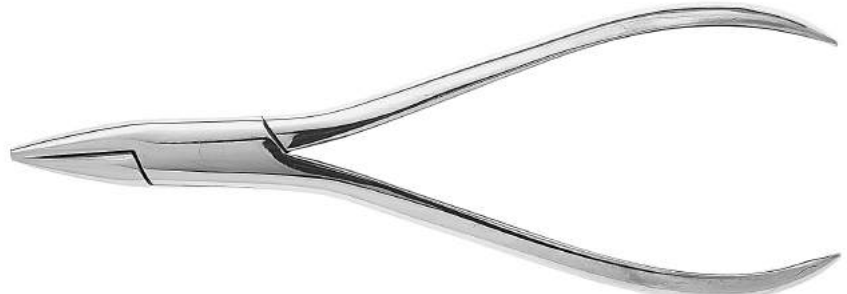

← 130 →

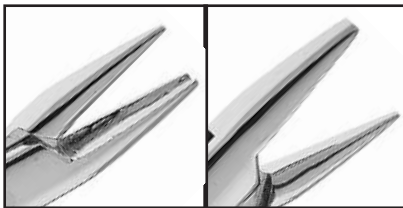

● da 1,50 a 7,40

☪ da 3,70 a 8,00

Wire bending KN 89.431.14

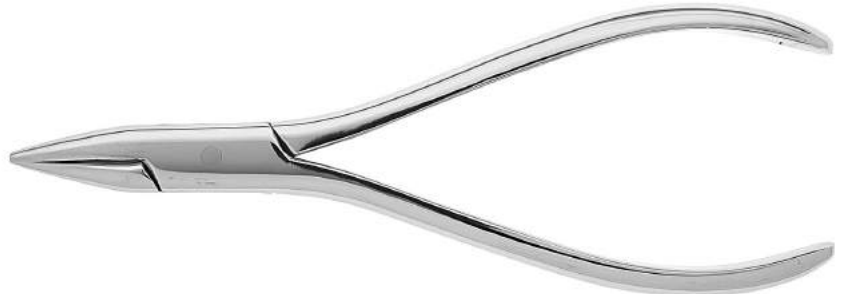

← 140 →

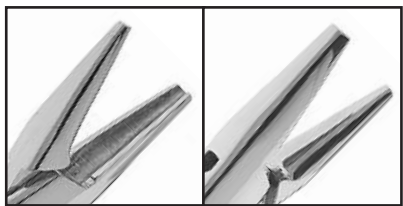

● da 2,50 a 9,50

☪ da 5,00 a 9,80

MC Kellops KN 89.431.15

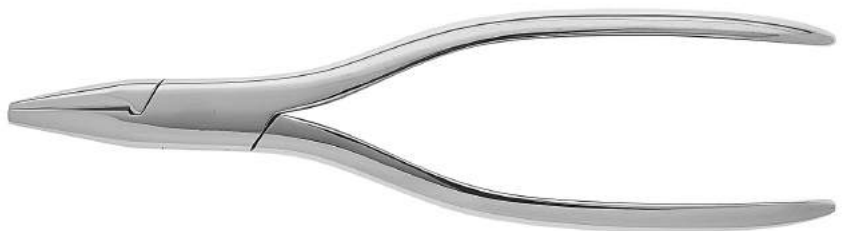

← 160 →

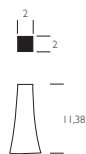
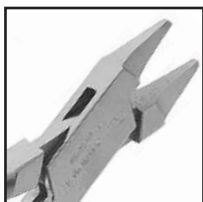

Adams KN 89.464.12

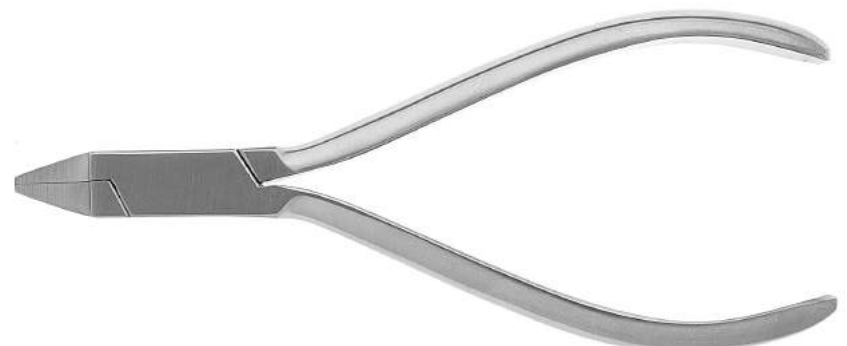

← 130 →

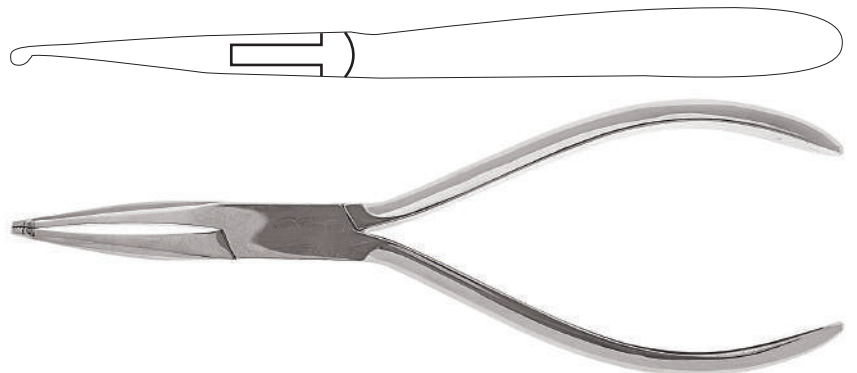

How diritta KN 89.130.14

140

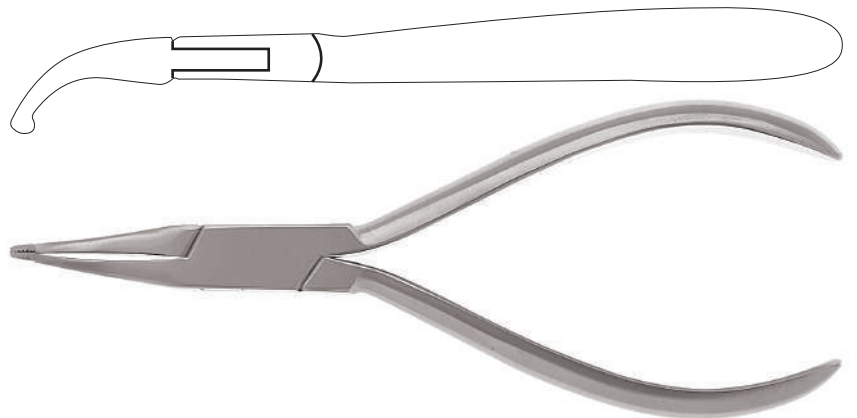
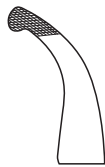

How curva KN 89.131.14

140

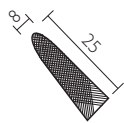

Goslee KN 89.554.14

140

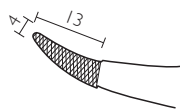

Goslee KN 89.500.35

140

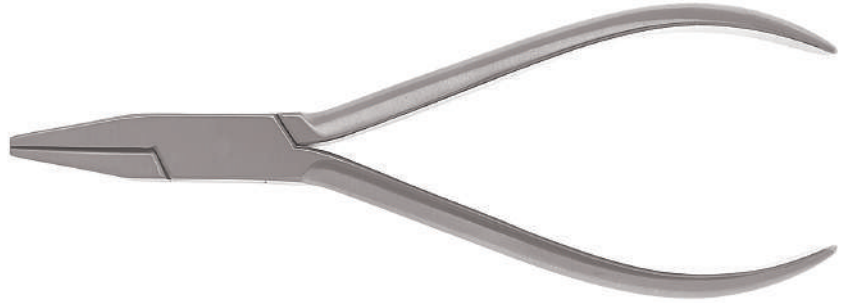
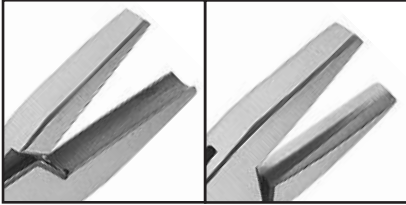

Hollow chop KN 89.140.12

← 130 →

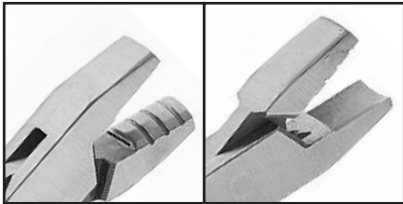

De la Rosa scanalata KN 89.141.12

← 130 →

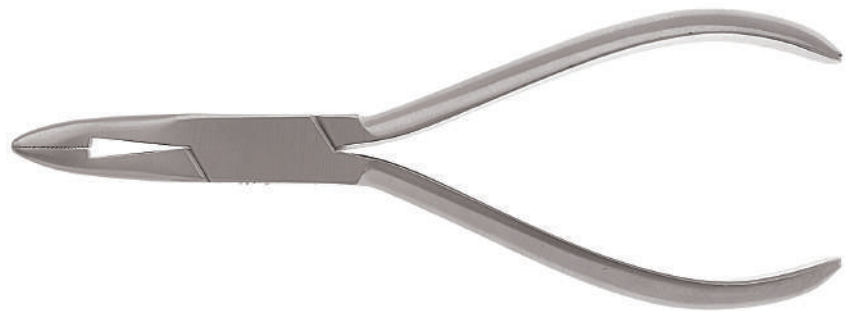
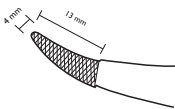

Weingart KN 89.142.13

← 185 →

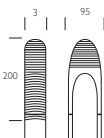
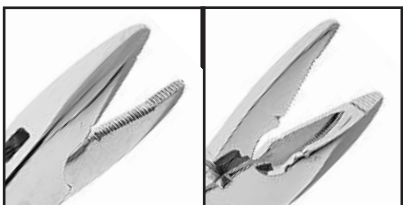

Waldsachs KN 89.143.15

← 150 →

Pinzette per Brackets



KN 89.590.20

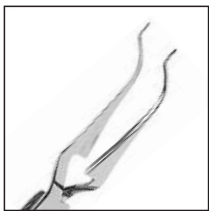
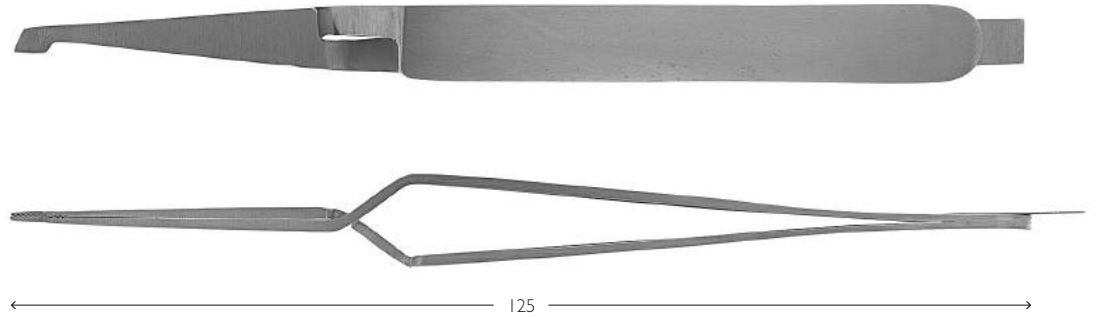

KN 89.590.21

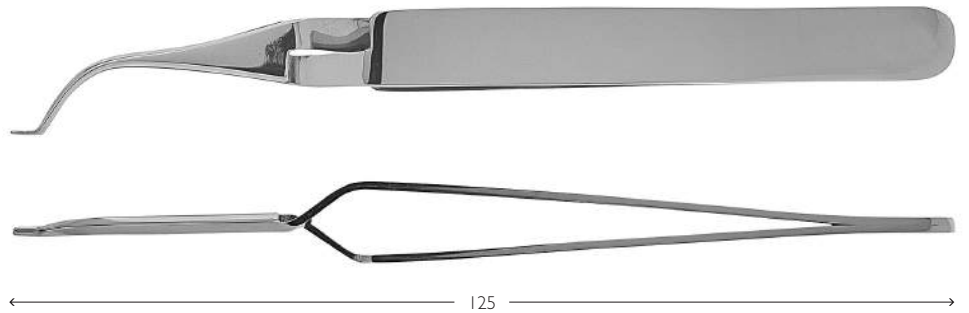

KN 89.590.23

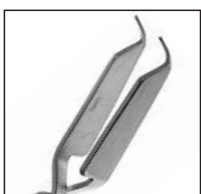
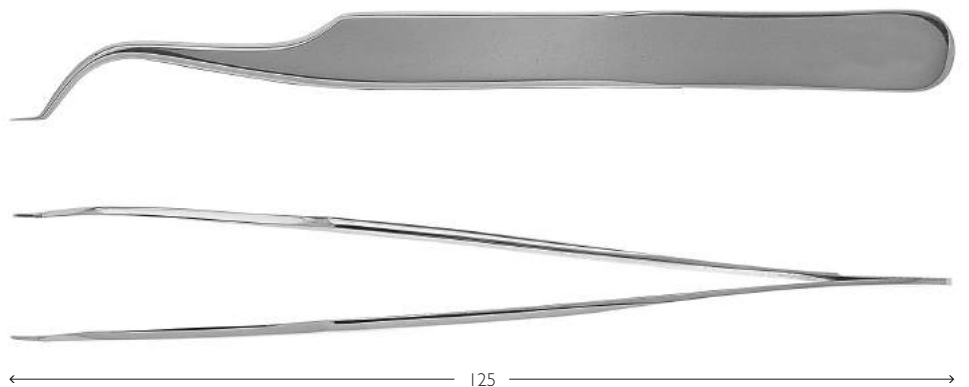

KN 89.590.24

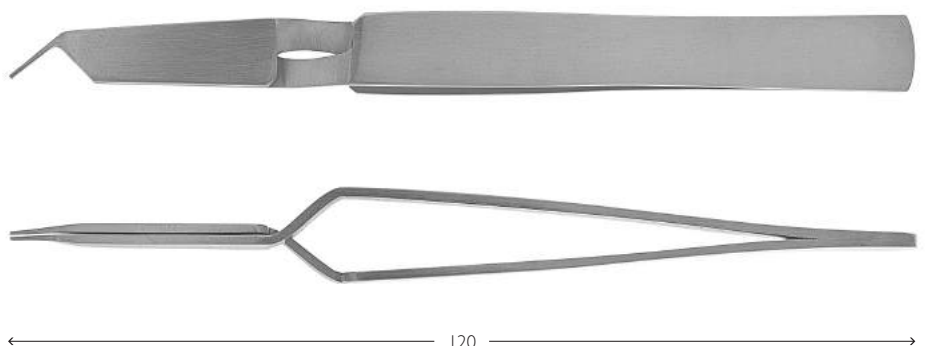

Direzionatore per legature

KN 89.500.22

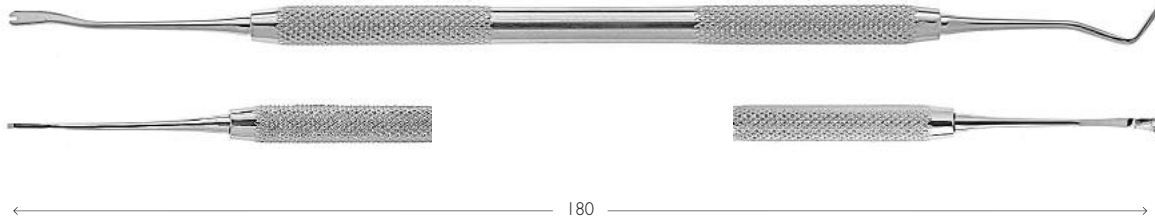

Direzionatore per legature

KN 89.590.22

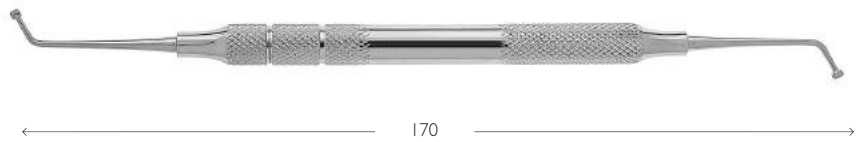

Strumenti per elastici

KN 89.590.01

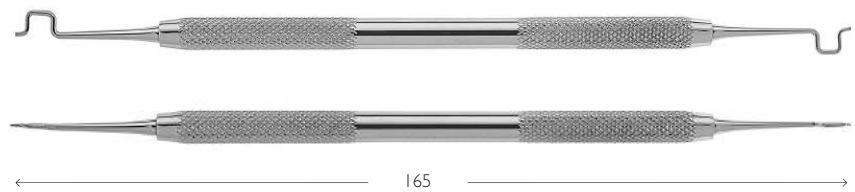

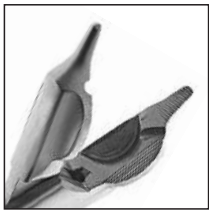

Pinza universale TC KN 89.560.16

← 160 →

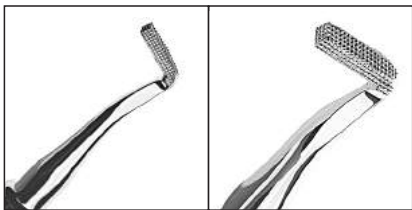

Spingibande KN 89.590.03

← 140 →

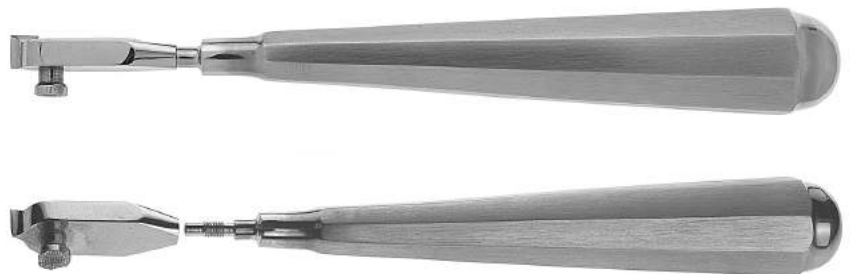

Spingibande Mershon KN 89.590.00

← 140 →

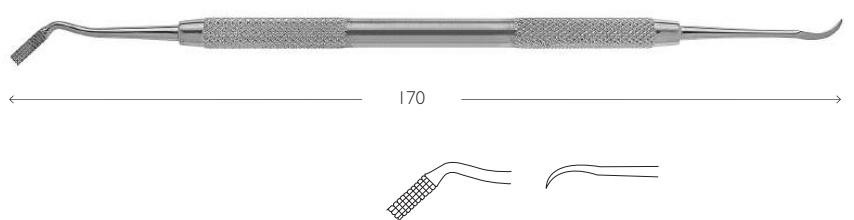

Strumenti per bande di utilità KN 89.500.24



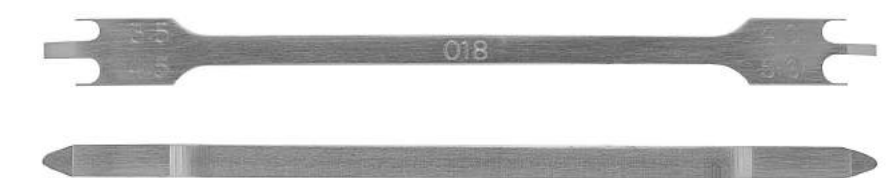
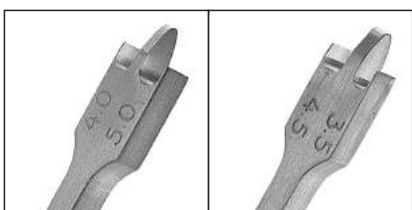



← 170 →

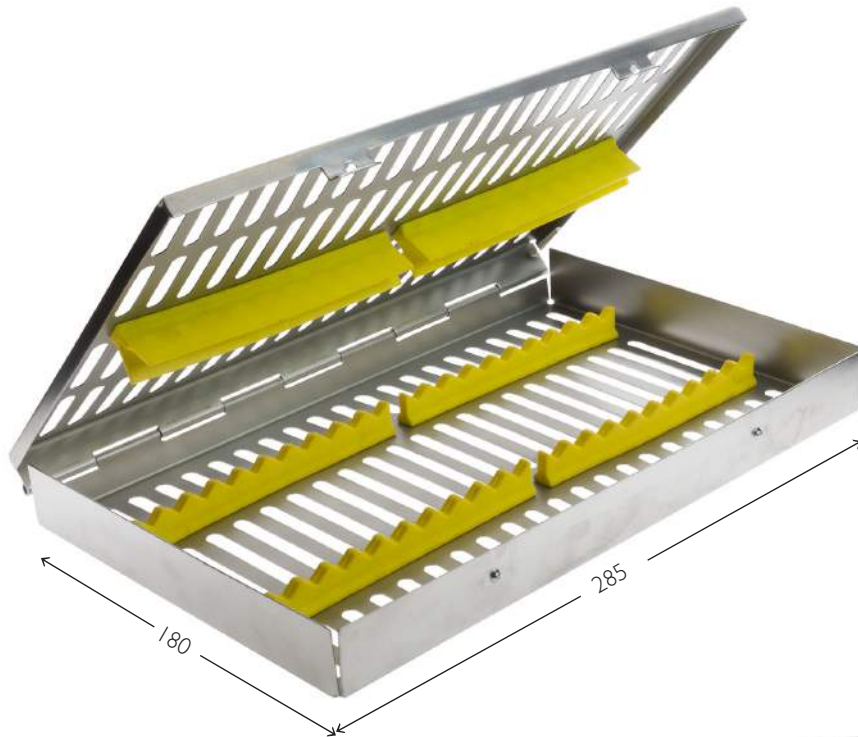

Altimetro in alluminio KN 89.500.24

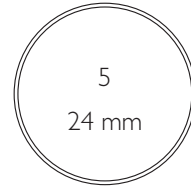
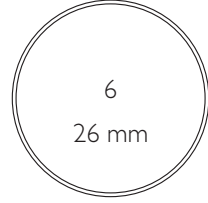
← 150 →



					
	Piano Plan Plane Planos	Z - 3400	Z - 3401	Z - 3402	Z - 3403
	Ingrandimento Vergrobernd Magnifying De aumento		Z - 3405	Z - 3406	
	Rodio Rodium	Z - 3408	Z - 3409	Z - 3410	Z - 3411
	Doppio Rodio Doppelt Rodium Double Rodium Doble Rodium			Z - 3420	
Cone - Socket					
	Piano Cone - Socket Plan Cone - Socket Plane Cone - Socket Planos Cone - Socket		Z - 3413	Z - 3414	
	Rodio Cone - Socket Rodium Cone - Socket		Z - 3416	Z - 3417	
	Doppio Rodio Cone - Socket Doppelt Rodium Cone - Socket Double Rodium Cone - Socket Doble Rodium Cone - Socket			Z - 3421	

Bicchierini

Strumentario

Koine

Shorts

Shorts

Pantalones Cortos



Dappen Blu



Dappen Trasparente



Dappen Giallo



Dappen Verde

KN 84.360.00

Vassoio portastrumenti

Strumentario



Instrument Trays

Instrumententablar

Bandejas de Instrumentos



Tray 20 Strumenti :

	KN 90.120.01
	KN 90.120.02
	KN 90.120.03
	KN 90.120.04

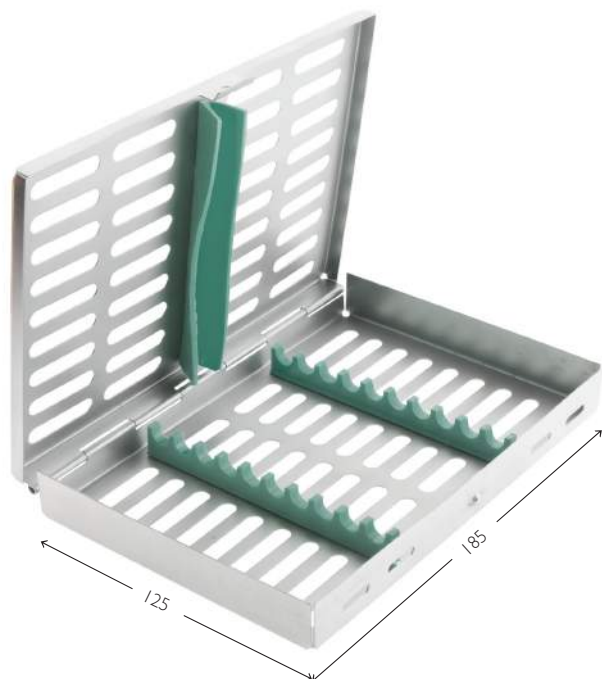

Tray 10 Strumenti :

	KN 90.110.01
	KN 90.110.02
	KN 90.110.03
	KN 90.110.04

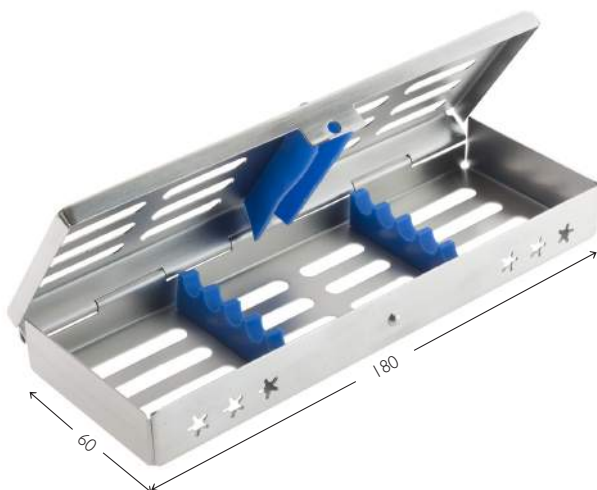

Tray 5 Strumenti :

	KN 90.105.01
	KN 90.105.02
	KN 90.105.03
	KN 90.105.04

Bacinella reniforme

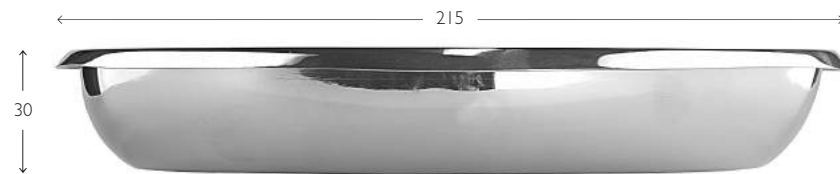

KN 90.010.20



KN 90.050.06



KN 90.050.16

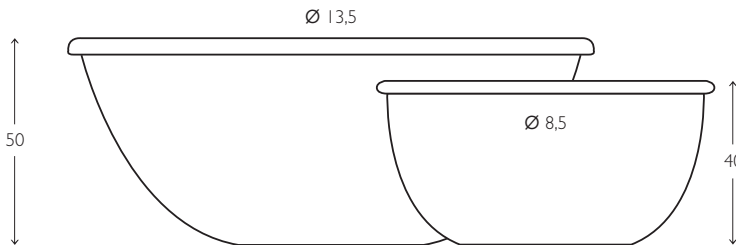

KN 90.050.12

KN 90.051.03

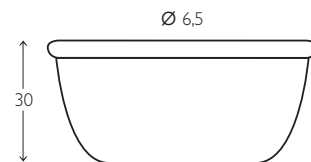

KN 90.050.60

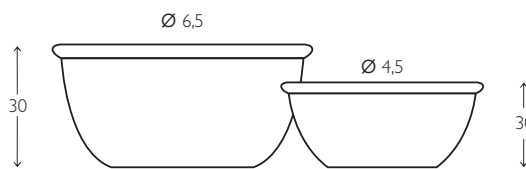

KN 90.050.05

KN 90.050.55