

## SISTEM GLISANTĂ STICLA SECURIZATA 4-14-4

DESPRE  
SCHITĂ  
PROFILE  
ACCESORII



ILUMINARE LED SAMSUNG



MOTORIZARE SOMFY



SMART REMOTE CONTROL



PERSONALIZARE PROFILE



SISTEM COLECTARE APĂ

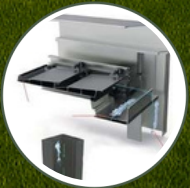

IMPERMEABILITATE 100%



ÎNCHIDERE ZIP SCREEN



VOPSIRE COATEX

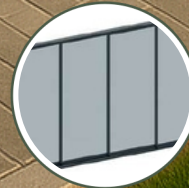

GLISANTE



GHILOTINE

[www.vegaproduct.ro](http://www.vegaproduct.ro)

+4076 027 3174

# SISTEME DE ÎNCHIDERE CU STICLĂ CULISANTĂ

Sistemele de sticlă glisantă sunt o soluție modernă pentru închiderea teraselor, balcoanelor sau foișoarelor, oferind protecție eficientă împotriva vântului, ploii și prafului, fără a compromite deschiderea spațiului către exterior.

Panourile din sticlă securizată se glisează ușor pe căile de rulare, oferind flexibilitate în utilizare și păstrând o vedere panoramică neobstrucționată. Sistemul permite aerisirea naturală și controlul nivelului de deschidere în funcție de sezon sau preferințe.

Cu un design minimalist și adaptabil, aceste închideri contribuie la extinderea funcțională a spațiilor exterioare, fără a altera arhitectura clădirii. Sunt ideale pentru cei care își doresc un spațiu protejat, dar deschis vizual și ușor de utilizat.



**CULOAREA LA ALEGEREA DVS., CONFORM  
CU STANDARDUL DE CULOARE RAL.**



**ESTE EXTREM DE REZISTENTĂ LA CONDIȚII  
METEO EXTREME. PLOI ȘI VANT.**



**MATERIALE // 6063 T5 ALUMINIU, INOX ȘI DERLIN.**

Sistemele de sticlă glisantă sunt o soluție versatilă pentru închiderea teraselor, balcoanelor sau foaișoarelor, oferind protecție împotriva vântului, ploii și prafului, fără a afecta accesul la lumină naturală sau priveliște.

Disponibile în variante cu sau fără rame verticale, aceste sisteme se pot adapta la cerințele arhitecturale și estetice ale fiecărui spațiu. Cele fără rame oferă un aspect continuu și modern, în timp ce variantele cu rame aduc un plus de etanșeitate și stabilitate, utile în zonele expuse la vânt sau ploi puternice.

Folosite frecvent atât în proiecte rezidențiale, cât și comerciale, închiderile din sticlă glisantă transformă spațiile exterioare în zone protejate, ușor de folosit în orice sezon. Sunt soluții durabile, ușor de întreținut și care adaugă valoare estetică oricărui imobil.





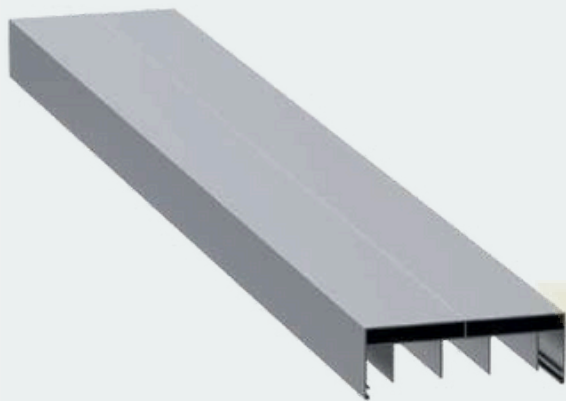

Üst Ray Profili / Top Rail Profile

Cod produs	2069
Greutate	2.054 kg/m 4.528 lb/m

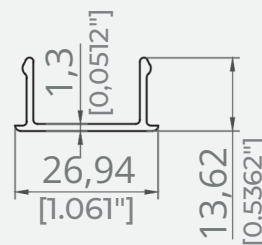
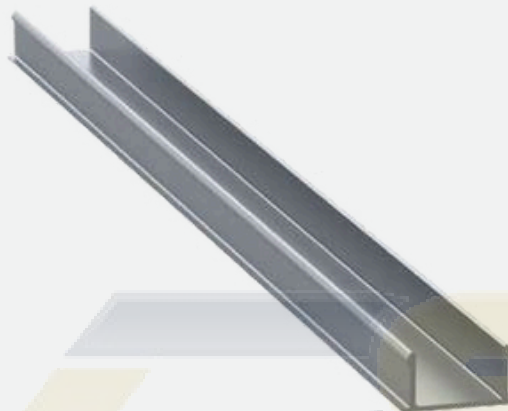

Profil capac șină laterală

Cod produs	2067
Greutate	0,186 kg/m 0,410 lb/m

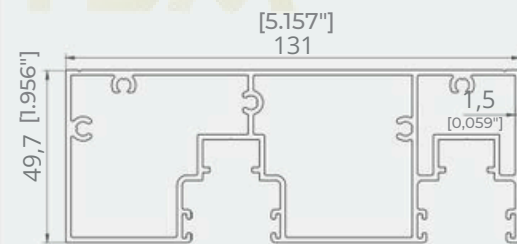

Yan Ray Profili / Side Rail Profile

Cod produs	2066
Greutate	2.414 kg/m 5.322 lb/m

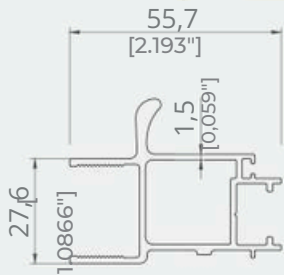

PROFIL CAPAC STICLĂ 60X17,2

COD PRODUS	2068
GREUTATE	0,878 kg/m 1.936 lb/m

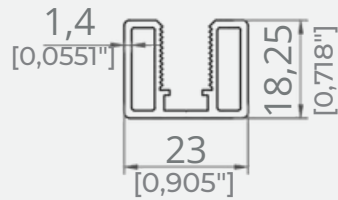
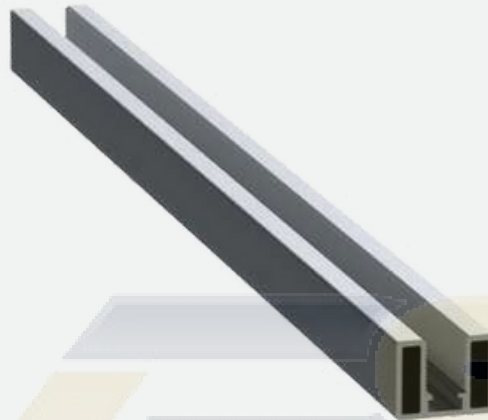

PROFIL ADAPTOR DE STICLĂ DE 8 MM

COD PRODUS	2150
GREUTATE	0,375 kg/m 0,827 lb/m

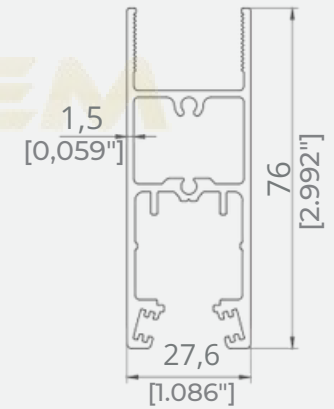

PROFIL BAZĂ PANOUL STICLĂ 22 MM

COD PRODUS	2565
GREUTATE	1.205 kg/m 2.657 lb/m

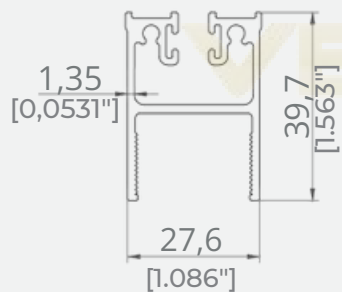

PROFIL SUPERIOR PANOU STICLĂ 22 MM

COD PRODUS	2071
GREUTATE	0,703 kg/m 1.550 lb/m

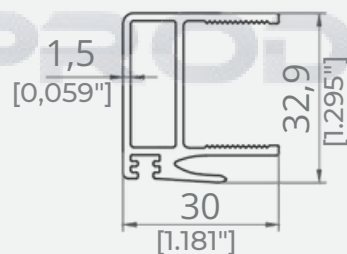
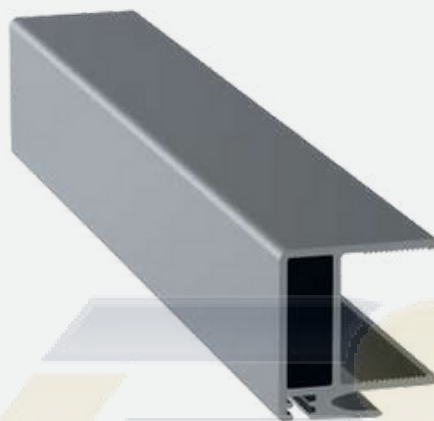

PROFIL CAPAC LATERAL STICLĂ 62,2X32,3

COD PRODUS	2065
GREUTATE	0,585 kg/m 1.290 lb/m

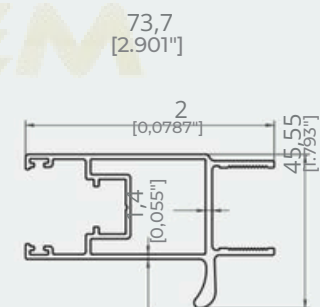

PROFIL DE ÎMBINARE PENTRU ARIPĂ MIJLOC

COD PRODUS	2149
GREUTATE	1.160 kg/m 2.557 lb/m

  
**SET GLISANT DREAPTA**  
Cod: Srm-01





 PANĂ COLȚ INFERIOARĂ PENTRU CARCASĂ	 PANĂ COLȚ SUPERIOARĂ PENTRU CARCASĂ	 ROATĂ DUBLĂ INFERIOARĂ GLISANTĂ	 PLASTIC SUPERIOR ARIPĂ CU BRAȚ	 PLASTIC INFERIOR ARIPĂ CU BRAȚ	 PLASTIC SUPERIOR ARIPĂ CU CLEMĂ	 ROATĂ SUPERIOARĂ GLISANTĂ	 PLASTIC INFERIOR ARIPĂ CU CLEMĂ
COD BUCĂȚI	COD BUCĂȚI	COD BUCĂȚI	COD BUCĂȚI	COD BUCĂȚI	COD BUCĂȚI	COD BUCĂȚI	COD BUCĂȚI
Srm-01	Srm-01	Srm-07	Srm-01	Srm-01	Srm-01	Srm-11	Srm-01
2	2	8	2	2	6	16	2

  
**SET GLISANT STÂNGA**  
Cod: Srm-02

 PANĂ COLȚ INFERIOARĂ CARCASĂ	 PANĂ COLȚ SUPERIOARĂ PENTRU CARCASĂ	 ROATĂ DUBLĂ INFERIOARĂ GLISANTĂ	 PLASTIC SUPERIOR ARIPĂ CU BRAȚ	 PLASTIC INFERIOR ARIPĂ CU BRAȚ	 PLASTIC SUPERIOR ARIPĂ CU CLEMĂ	 ROATĂ SUPERIOARĂ GLISANTĂ	 PLASTIC INFERIOR ARIPĂ CU CLEMĂ
COD BUCĂȚI	COD BUCĂȚI	COD BUCĂȚI	COD BUCĂȚI	COD BUCĂȚI	COD BUCĂȚI	COD BUCĂȚI	COD BUCĂȚI
Srm-02	Srm-02	Srm-07	Srm-02	Srm-02	Srm-02	Srm-11	Srm-02
2	2	8	2	2	6	16	2

  
**ACCESORII PENTRU STICLĂ GLISANTĂ**

 PANĂ COLȚ INFERIOARĂ CARCASĂ	 PANĂ COLȚ SUPERIOARĂ PENTRU CARCASĂ	 ROATĂ DUBLĂ INFERIOARĂ GLISANTĂ	 PLASTIC SUPERIOR ARIPĂ CU BRAȚ	 PLASTIC INFERIOR ARIPĂ CU BRAȚ	 PLASTIC SUPERIOR ARIPĂ CU CLEMĂ
COD BUCĂȚI	COD BUCĂȚI	COD BUCĂȚI	COD BUCĂȚI	COD BUCĂȚI	COD BUCĂȚI
Srm-03	Srm-04	Srm-12-1	Srm-13-1	Srm-12	Srm-13
2	6	1	1	1	1

 PLASTIC DE ÎMBINARE MIJLOC GLISANT	 EPDM CONTRA EPDM BOLT	 PERIE 6.7X550	 PERIE 4.8X450	
COD BUCĂȚI	COD BUCĂȚI	COD BUCĂȚI	COD BUCĂȚI	
Srm-17	Srm-16	Srm-14	Srm-15	
1	300 meters	375 Meters 1500 Meters	550 Meters 2200 Meters	

3 Metri (Max)

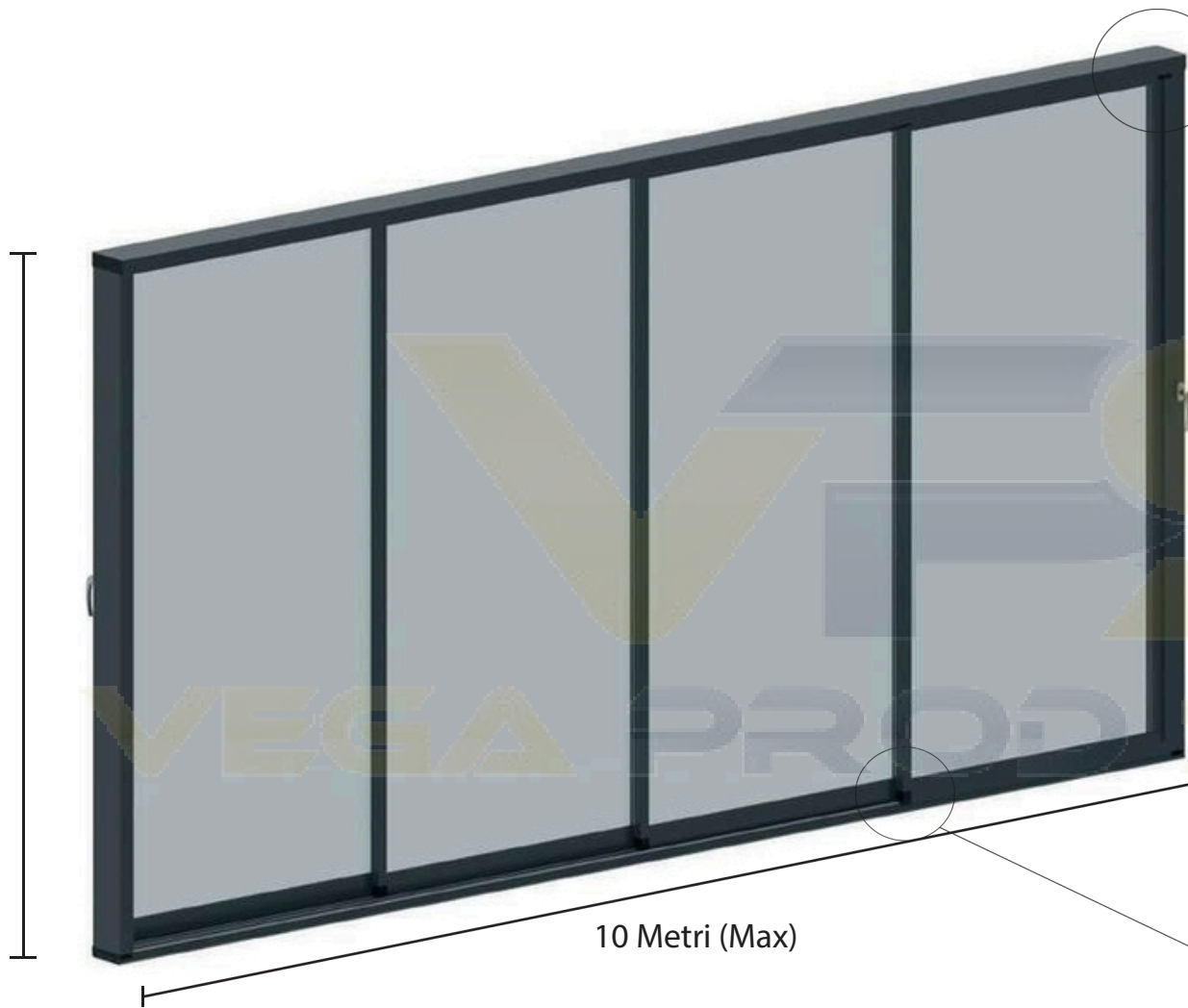

10 Metri (Max)



**Proiecte Finalizate :**



# VPS

## VEGA PROD SISTEM

 [www.vegaprod.ro](http://www.vegaprod.ro)

 [office@vegaprod.ro](mailto:office@vegaprod.ro)

 [+4076 027 3174](tel:+40760273174)

[@vegaprod.ro](#)

